



AGENDA
CITY COUNCIL OF THE CITY OF MORENO VALLEY
MORENO VALLEY COMMUNITY SERVICES DISTRICT
CITY AS SUCCESSOR AGENCY FOR THE
COMMUNITY REDEVELOPMENT AGENCY OF
THE CITY OF MORENO VALLEY
MORENO VALLEY HOUSING AUTHORITY
BOARD OF LIBRARY TRUSTEES

December 19, 2017

REGULAR MEETING – 6:00 PM

City Council Study Sessions

Second Tuesday of each month – 6:00 p.m.

City Council Meetings

Special Presentations – 5:30 P.M.

First & Third Tuesday of each month – 6:00 p.m.

City Council Closed Session

Will be scheduled as needed at 4:30 p.m.

City Hall Council Chamber – 14177 Frederick Street

Upon request, this agenda will be made available in appropriate alternative formats to persons with disabilities, in compliance with the Americans with Disabilities Act of 1990. Any person with a disability who requires a modification or accommodation in order to participate in a meeting should direct such request to Guy Pegan, ADA Coordinator, at 951.413.3120 at least 72 hours before the meeting. The 72-hour notification will enable the City to make reasonable arrangements to ensure accessibility to this meeting.

Victoria Baca, Mayor Pro Tem
David Marquez, Council Member

Dr. Yxstian A. Gutierrez, Mayor

Jeffrey J. Giba, Council Member
Ulises Cabrera, Council Member

AGENDA
CITY COUNCIL OF THE CITY OF MORENO VALLEY
December 19, 2017

CALL TO ORDER - 5:30 PM

SPECIAL PRESENTATIONS

1. Presentation of a Commendation to Earl Williams
2. Presentation of a Commendation to Frank Wright
3. Special Recognition of Police Chief Joel Ontiveros

**AGENDA
JOINT MEETING OF THE
CITY COUNCIL OF THE CITY OF MORENO VALLEY
MORENO VALLEY COMMUNITY SERVICES DISTRICT
CITY AS SUCCESSOR AGENCY FOR THE
COMMUNITY REDEVELOPMENT AGENCY OF THE
CITY OF MORENO VALLEY
MORENO VALLEY HOUSING AUTHORITY
AND THE BOARD OF LIBRARY TRUSTEES**

***THE CITY COUNCIL RECEIVES A SEPARATE STIPEND FOR CSD
MEETINGS***

**REGULAR MEETING – 6:00 PM
DECEMBER 19, 2017**

CALL TO ORDER

Joint Meeting of the City Council, Community Services District, City as Successor Agency for the Community Redevelopment Agency, Housing Authority and the Board of Library Trustees - actions taken at the Joint Meeting are those of the Agency indicated on each Agenda item.

PLEDGE OF ALLEGIANCE

INVOCATION

Pastor Pete Perez, Purpose of Heart Ministries

ROLL CALL

INTRODUCTIONS

PUBLIC COMMENTS ON MATTERS ON THE AGENDA WILL BE TAKEN UP AS THE ITEM IS CALLED FOR BUSINESS, BETWEEN STAFF'S REPORT AND CITY COUNCIL DELIBERATION (SPEAKER SLIPS MAY BE TURNED IN UNTIL THE ITEM IS CALLED FOR BUSINESS.)

PUBLIC COMMENTS ON ANY SUBJECT NOT ON THE AGENDA UNDER THE JURISDICTION OF THE CITY COUNCIL

Those wishing to speak should complete and submit a BLUE speaker slip to the Sergeant-at-Arms. There is a three-minute time limit per person. All remarks and questions shall be addressed to the presiding officer or to the City Council.

JOINT CONSENT CALENDARS (SECTIONS A-D)

All items listed under the Consent Calendars, Sections A, B, C, and D are considered to be routine and non-controversial, and may be enacted by one motion unless a member of the City Council, Community Services District, City as Successor Agency for the Community Redevelopment Agency, Housing Authority or the Board of Library Trustees requests that an item be removed for separate action. The motion to adopt the Consent Calendars is deemed to be a separate motion by each Agency and shall be so recorded by the City Clerk. Items withdrawn for report or discussion will be heard after public hearing items.

A. CONSENT CALENDAR-CITY COUNCIL

- A.1. ORDINANCES - READING BY TITLE ONLY - THE MOTION TO ADOPT AN ORDINANCE LISTED ON THE CONSENT CALENDAR INCLUDES WAIVER OF FULL READING OF THE ORDINANCE.

Recommendation: Waive reading of all Ordinances.

- A.2. MINUTES - CITY COUNCIL - REGULAR MEETING - OCT 17, 2017 6:00 PM

Recommendation: Approve as submitted.

- A.3. COUNCIL DISCRETIONARY EXPENDITURE REPORTS FOR FISCAL YEAR 2017/2018 AS OF JULY 1, 2017 THROUGH OCTOBER 31, 2017 (Report of: City Clerk)

Recommendation:

1. Receive and file the Fiscal Year 2017/2018 Council Discretionary Expenditure Report as of July 1, 2016 through October 31, 2017.

- A.4. LIST OF PERSONNEL CHANGES (Report of: Human Resources)

Recommendation:

1. Ratify the list of personnel changes as described.

- A.5. AUTHORIZATION TO AWARD PROJECT-RELATED SERVICES AGREEMENTS FOR PLANNING ENTITLEMENT AND PLAN CHECK SERVICES TO MULTIPLE VENDORS (Report of: Community Development)

Recommendations:

1. Approve each Project-Related Services Agreement with Civic Solutions, Inc. and Annealta Group for Planning Entitlement and Plan Check Services.

2. Authorize the City Manager to execute each Project-Related Services Agreement with Civic Solutions, Inc. and Annealta Group, subject to the approval of the City Attorney.
 3. Authorize the Chief Financial Officer to approve purchase orders to Civic Solutions, Inc. and Annealta Group up to a maximum of five years from the Agreement effective date with each firm, in accordance with approved terms of the Agreements.
 4. Authorize the Chief Financial Officer to make any necessary budget adjustment appropriations related to expenditures and the equal and offsetting revenues.
- A.6. APPROVE AND EXECUTE AGREEMENT FOR THE INSTALLATION OF A MODULAR RESTROOM AND PICNIC SHELTER AT JOHN F. KENNEDY VETERANS MEMORIAL PARK (Report of: Parks & Community Services)

Recommendations:

1. Approve the Agreement for the Installation of a Modular Restroom and Picnic Shelter at John F. Kennedy Veterans Memorial Park with KASA Construction Inc.
 2. Authorize the Executive Director to execute the Agreement for the Installation of a Modular Restroom and Picnic Shelter at John F. Kennedy Veterans Memorial Park with KASA Construction Inc.; and issuance of the Purchase Order for construction beginning once the Agreement has been fully executed.
 3. Authorize the Executive Director to execute any subsequent related Extensions or Amendments to the Agreement, subject to the approval of the City Attorney.
 4. Authorize the Parks and Community Services Director to accept the improvements into the Community Services District's maintained system upon acceptance of the improvements as complete.
- A.7. TELECOMMUNICATIONS LICENSE AGREEMENT WITH NEW CINGULAR WIRELESS PCS, LLC, FOR CELL TOWER AT FIRE STATION 91 (Report of: Parks & Community Services)

Recommendation:

1. Authorize the Mayor to execute an Agreement for a new Telecommunications License Agreement with New Cingular Wireless PCS, LLC, on the property known as Fire Station 91; New Cingular Wireless PCS, LLC site number RS0058.

A.8. APPROVAL FOR THE USE OF ASSET FORFEITURE FUNDS TO PURCHASE EQUIPMENT FOR THE POLICE DEPARTMENT TRAFFIC DIVISION (Report of: Police Department)

Recommendations:

1. Authorize the police department to purchase 12 new Kustom Signals, Inc., Pro Laser IV, infrared LIDAR systems, at a cost of \$32,300.64 (\$29,940.00 for the LIDAR's & shipping, plus \$2,360.64 sales tax).
2. Authorize the police department to purchase 12 new Getac tablets to be used on the patrol motorcycles as a Mobile Dispatch Computer (MDC) and as an electronic ticket writer at a cost of \$39,081.91 (\$36,721.80 for the equipment, all related accessories and "e-waste" fees, plus \$2,360.11 sales tax).
3. Authorize a budget adjustment of \$71,383 to the General Fund (1010) Asset Forfeiture revenue account and the Traffic Enforcement expenditure account within the Police Department.

A.9. AMENDMENT TO THE EXISTING CONTRACT WITH INLAND EMPIRE PROPERTY SERVICE, INC. FOR ON-SITE/OR PROFESSIONAL SERVICES FOR HAZARD ABATEMENT (Report of: Fire Department)

Recommendation:

1. Approve an amendment to the existing contract with Inland Empire Property Service, Inc. for Hazard Abatement Services not to exceed \$150,000 per year with a maximum contract of \$750,000.
2. Authorize the City Manager to execute the Agreement with Inland Empire Property Service, Inc.
3. Authorize a change order in the amount of \$75,000 to the purchase order for Inland Empire Property Service, Inc. for Fiscal Year 2017/2018, not to exceed a total of \$150,000.
4. Authorize the City Manager to approve the annual purchase order for the remaining four years of Inland Empire Property Service, Inc. contract, not to exceed \$150,000 for each year.
5. Authorize the Chief Financial Officer to appropriate an additional \$75,000 as revenue and expense in the General Fund (Fund 1010) Nuisance Abatement Account for FY 2017/18 and FY 2018/19.

B. CONSENT CALENDAR-COMMUNITY SERVICES DISTRICT

- B.1. ORDINANCES - READING BY TITLE ONLY - THE MOTION TO ADOPT AN ORDINANCE LISTED ON THE CONSENT CALENDAR INCLUDES WAIVER OF FULL READING OF THE ORDINANCE.

Recommendation: Waive reading of all Ordinances.

- B.2. MINUTES - REGULAR MEETING OF OCT 17, 2017 6:00 PM (See A.2)

Recommendation: Approve as submitted.

C. CONSENT CALENDAR - HOUSING AUTHORITY

- C.1. ORDINANCES - READING BY TITLE ONLY - THE MOTION TO ADOPT AN ORDINANCE LISTED ON THE CONSENT CALENDAR INCLUDES WAIVER OF FULL READING OF THE ORDINANCE.

Recommendation: Waive reading of all Ordinances.

- C.2. MINUTES - REGULAR MEETING OF OCT 17, 2017 6:00 PM (See A.2)

Recommendation: Approve as submitted.

D. CONSENT CALENDAR - BOARD OF LIBRARY TRUSTEES

- D.1. ORDINANCES - READING BY TITLE ONLY - THE MOTION TO ADOPT AN ORDINANCE LISTED ON THE CONSENT CALENDAR INCLUDES WAIVER OF FULL READING OF THE ORDINANCE.

Recommendation: Waive reading of all Ordinances.

- D.2. MINUTES - REGULAR MEETING OF OCT 17, 2017 6:00 PM (See A.2)

Recommendation: Approve as submitted.

E. PUBLIC HEARINGS

Questions or comments from the public on a Public Hearing matter are limited to five minutes per individual and must pertain to the subject under consideration.

Those wishing to speak should complete and submit a GOLDENROD speaker slip to the Sergeant-at-Arms.

- E.1. A CITYWIDE MUNICIPAL CODE (TITLE 9) AMENDMENT ADDRESSING LAND USE REGULATIONS FOR ACCESSORY DWELLING (Report of: Community Development)

Recommendations: That the City Council:

1. Certify that the proposed Municipal Code Amendment (PEN17-0115) is exempt under the California Environmental Quality Act (CEQA) in accordance with Section 15282(h) of the CEQA Guidelines which specifically exempts adoption of an ordinance regarding accessory dwelling units; and
2. Introduce Ordinance No. _____. An Ordinance of the City Council of the City of Moreno Valley, California, amending Title 9 of the City of Moreno Valley Municipal Code addressing Accessory Dwelling Units (ADUs) to ensure compliance with new State of California laws.

- E.2. PUBLIC HEARING FOR THE FIVE YEAR CONSOLIDATED PLAN FOR PROGRAM YEARS 2018/2019 - 2022/2023 AND THE ANNUAL ACTION PLAN FOR PROGRAM YEAR 2018-2019 & TO ADOPT PROGRAM YEAR 2018-2019 OBJECTIVES AND POLICIES. (Report of: Financial & Management Services)

Recommendations: That the City Council:

1. Conduct a Public Hearing to allow for the public to comment on the needs of low-and-moderate income residents in Moreno Valley.
2. Approve the proposed CDBG, HOME, and ESG Grant Objectives and Policies for the 2018-2019 Program Year.

F. ITEMS REMOVED FROM CONSENT CALENDARS FOR DISCUSSION OR SEPARATE ACTION

G. GENERAL BUSINESS

- G.1. RESOLUTION AMENDING AGENDA POSTING REQUIREMENTS TO MATCH STATE LAW (Report of: City Attorney)

Recommendations: That the City Council:

1. Consider adoption of the Resolution amending Rules of Procedure Section 1.1.2.3 to set posting and delivery of the City Council meeting agenda at 72 hours.

G.2. CONSIDERATION OF AN ORDINANCE CREATING THE PARKS, COMMUNITY SERVICES AND TRAILS COMMITTEE AND DISSOLVING PARKS AND RECREATION COMMISSION AND RECREATIONAL TRAILS BOARD (Report of: Parks & Community Services)

Recommendations: That the City Council:

1. Introduce and conduct the first reading of Ordinance _____ creating the Parks, Community Services and Trails Committee.

H. REPORTS

H.1. CITY COUNCIL REPORTS ON REGIONAL ACTIVITIES
(Informational Oral Presentation - not for Council action)

March Joint Powers Commission (JPC)

Riverside County Habitat Conservation Agency (RCHCA)

Riverside County Transportation Commission (RCTC)

Riverside Transit Agency (RTA)

Western Riverside Council of Governments (WRCOG)

Western Riverside County Regional Conservation Authority (RCA)

School District/City Joint Task Force

Southern California Association of Governments (SCAG)

H.2. CITY MANAGER'S REPORT
(Informational Oral Presentation - not for Council action)

H.3. CITY ATTORNEY'S REPORT
(Informational Oral Presentation - not for Council action)

CLOSING COMMENTS AND/OR REPORTS OF THE CITY COUNCIL, COMMUNITY SERVICES DISTRICT, CITY AS SUCCESSOR AGENCY FOR THE COMMUNITY REDEVELOPMENT AGENCY, HOUSING AUTHORITY AND THE BOARD OF LIBRARY TRUSTEES.

ADJOURNMENT

PUBLIC INSPECTION

The contents of the agenda packet are available for public inspection on the City's website at www.moval.org and in the City Clerk's office at 14177 Frederick Street during normal business hours.

Any written information related to an open session agenda item that is known by the City to have been distributed to all or a majority of the City Council less than 72 hours prior to this meeting will be made available for public inspection on the City's website at www.moval.org and in the City Clerk's office at 14177 Frederick Street during normal business hours.

CERTIFICATION

I, Pat Jacquez-Nares, City Clerk of the City of Moreno Valley, California, certify that 72 hours prior to this Regular Meeting, the City Council Agenda was posted on the City's website at: www.moval.org and in the following three public places pursuant to City of Moreno Valley Resolution No. 2007-40:

City Hall, City of Moreno Valley
14177 Frederick Street

Moreno Valley Library
25480 Alessandro Boulevard

Moreno Valley Senior/Community Center
25075 Fir Avenue

Pat Jacquez-Nares, CMC & CERA
City Clerk

Date Posted: December 7, 2017

**MINUTES
CITY COUNCIL REGULAR MEETING OF THE CITY OF MORENO VALLEY
October 17, 2017**

CALL TO ORDER - 5:30 PM

SPECIAL PRESENTATIONS

1. Friends of the Moreno Valley Library Proclamation
2. Officer of the Second Quarter: Kenneth Hoon
3. Medic Squad 6 Presentation

**MINUTES
JOINT MEETING OF THE
CITY COUNCIL OF THE CITY OF MORENO VALLEY
MORENO VALLEY COMMUNITY SERVICES DISTRICT
CITY AS SUCCESSOR AGENCY FOR THE
COMMUNITY REDEVELOPMENT AGENCY OF THE
CITY OF MORENO VALLEY
MORENO VALLEY HOUSING AUTHORITY
BOARD OF LIBRARY TRUSTEES**

**REGULAR MEETING – 6:00 PM
October 17, 2017**

CALL TO ORDER

The Joint Meeting of the City Council of the City of Moreno Valley, Moreno Valley Community Services District, City as Successor Agency for the Community Redevelopment Agency of the City of Moreno Valley, Moreno Valley Housing Authority and the Board of Library Trustees was called to order at 6:02 p.m. by Mayor Gutierrez in the Council Chamber located at 14177 Frederick Street.

PLEDGE OF ALLEGIANCE

Pledge of Allegiance was led by Frank Wright.

INVOCATION

Reverend Dr. Steven Overton, Moreno Valley Christian Chapel Foursquare Church

ROLL CALL

| | | |
|----------|--------------------------|----------------|
| Council: | Ulises Cabrera | Council Member |
| | Dr. Yxstian A. Gutierrez | Mayor |
| | Jeffrey J. Giba | Council Member |
| | David Marquez | Council Member |
| | Victoria Baca | Mayor Pro Tem |

INTRODUCTIONS

Staff:

| | |
|--------------------|--------------------------|
| Michelle Dawson | City Manager |
| Martin Koczanowicz | City Attorney |
| Pat Jacquez-Nares | City Clerk |
| Thomas M. DeSantis | Assistant City Manager |
| Michael Lloyd | Interim City Engineer |
| Kathleen Sanchez | Human Resources Director |

Minutes Acceptance: Minutes of Oct 17, 2017 6:00 PM (CONSENT CALENDAR-CITY COUNCIL)

Betsy Adams
 Mike Lee
 Allen Brock
 Lt. Tyler Clark
 Mark Williams

Interim Parks Director
 Economic Development Director
 Community Development Director
 MVPD
 MVFD

PUBLIC COMMENTS ON MATTERS ON THE AGENDA WILL BE TAKEN UP AS THE ITEM IS CALLED FOR BUSINESS, BETWEEN STAFF'S REPORT AND CITY COUNCIL DELIBERATION (SPEAKER SLIPS MAY BE TURNED IN UNTIL THE ITEM IS CALLED FOR BUSINESS.)

PUBLIC COMMENTS ON ANY SUBJECT NOT ON THE AGENDA UNDER THE JURISDICTION OF THE CITY COUNCIL

Bob Palomarez

1. AB 890 bill was defeated thanks to Mayor Pro Tem Baca and Mayor Gutierrez.
2. The World Logistics Center is a green project which will bring jobs to the City.

Paul Lovato

1. Prays for the City, the youth and the Council.
2. He is a 37 year resident of Moreno Valley.
3. The City does not need Cannabis and weed dispensaries.

Frank Wright

1. Pleased with the defeat of AB 890 Bill for Moreno Valley to be more productive.
2. Proud to be a member of the City.

Rafael Bruqueras

1. Thankful for prayers for Puerto Rico and his father.
2. AB 890 Bill was defeated thanks to Governor Jerry Brown.

Roy Bleckert

1. Pleased Governor Brown vetoed AB 890 Bill.
2. Thanked Council Members and other elected officials for opposing AB 890 Bill.
3. Requests Council review CEQA Reform.

Christopher Mauldin

1. Pleased with the defeat of AB 890 Bill.
2. Against the public marijuana dispensaries.
3. Receiving old mail from the previous from tenant three years ago and personal mail being delivered is late.

JOINT CONSENT CALENDARS (SECTIONS A-D)

Motion to Approve Joint Consent Calendar Items A.1 through D.3 with the exception of A.12 which was removed from the agenda and A.15 which was pulled for separate discussion by Council Member Giba.

| | |
|------------------|---|
| RESULT: | APPROVED [UNANIMOUS] |
| MOVER: | Victoria Baca, Mayor Pro Tem |
| SECONDER: | Ulises Cabrera, Council Member |
| AYES: | Cabrera, Gutierrez, Giba, Marquez, Baca |

A. CONSENT CALENDAR-CITY COUNCIL

Mayor Gutierrez opened the consent Agenda Items for public comments, which were received from Rafael Brugueras (Supports Item A.13) and Jessica Hedlund (Item A,14).

- A.1. ORDINANCES - READING BY TITLE ONLY - THE MOTION TO ADOPT AN ORDINANCE LISTED ON THE CONSENT CALENDAR INCLUDES WAIVER OF FULL READING OF THE ORDINANCE.

Recommendation: Waive reading of all Ordinances.

- A.2. City Council - Study Session - Mar 14, 2017 6:00 PM

Recommendation: Approve as submitted.

- A.3. City Council - Special Meeting - Mar 14, 2017 6:30 PM

Recommendation: Approve as submitted.

- A.4. City Council - Study Session - Mar 28, 2017 6:00 PM

Recommendation: Approve as submitted.

- A.5. City Council - Special Meeting - Mar 30, 2017 5:30 PM

Recommendation: Approve as submitted.

- A.6. City Council - Study Session - Apr 11, 2017 6:00 PM

Recommendation: Approve as submitted.

- A.7. City Council - Study Session - Jun 13, 2017 6:00 PM

Recommendation: Approve as submitted.

- A.8. City Council - Special Meeting (Ceremonial Swearing-in) - Jun 16, 2017 4:00 PM

Recommendation: Approve as submitted.

A.9. LIST OF PERSONNEL CHANGES (Report of: Human Resources)

Recommendation:

1. Ratify the list of personnel changes as described.

A.10. PURSUANT TO A LANDOWNER PETITION, ANNEX THREE PARCELS INTO COMMUNITY FACILITIES DISTRICT NO. 2014-01 (MAINTENANCE SERVICES) - AS AMENDMENT NO. 24 (Report of: Public Works)

Recommendation:

1. Acting as the legislative body of Community Facilities District No. 2014-01 (Maintenance Services), adopt Resolution No. 2017-53, a Resolution of the City Council of the City of Moreno Valley, California, ordering the annexation of territory to City of Moreno Valley Community Facilities District No. 2014-01 (Maintenance Services) and approving the amended map for said District.

A.11. APPROVE PROFESSIONAL SERVICES AGREEMENT WITH LEIDOS ENGINEERING, LLC FOR AN ORGANIZATIONAL ASSESSMENT OF MORENO VALLEY UTILITY (Report of: Financial & Management Services)

Recommendations:

1. Approve the Professional Services Agreement with Leidos Engineering, LLC for an Organizational Assessment of Moreno Valley Utility.
2. Authorize the City Manager to execute the Agreement upon City Attorney review and approval.

A.12. APPROVAL OF POWER PURCHASE AGREEMENT FOR RENEWABLE RESOURCES BETWEEN THE CITY OF MORENO VALLEY (AS BUYER) AND SUSTAINABLE POWER GROUP, LLC (AS SELLER) (Report of: Financial & Management Services)

Recommendations:

1. Approve the Power Purchase Agreement for Renewable Resources between the City of Moreno Valley (as Buyer) and Sustainable Power Group, LLC (as Seller).
2. Authorize the City Manager to execute the Power Purchase Agreement upon review and approval by the City Attorney.

- A.13. Historical Preservation Update (Report of: Financial & Management Services)

Recommendation:

1. Receive and file the background information on the City's historical assets of the fire engine and Red Cross building.
2. Approve the designated use and restriction of the City's Cultural Preservation Fund as set forth in the staff report.

- A.14. RESOLUTION EXTENDING ORDINANCE 916 BANNING ALL COMMERCIAL CANNABIS ACTIVITY IN THE CITY (Report of: City Attorney)

Council Member Giba was not in consensus to move this item to the October 24, 2017 Special Council Meeting. Council Member Giba voted (Aye) on the Consent Calendar with the removal of Item A.14.

Recommendation:

Staff recommends that the City Council adopt a Resolution, extending the existing ban on commercial cannabis activity, until permanent regulations can be adopted.

B. CONSENT CALENDAR-COMMUNITY SERVICES DISTRICT

- B.1. ORDINANCES - READING BY TITLE ONLY - THE MOTION TO ADOPT AN ORDINANCE LISTED ON THE CONSENT CALENDAR INCLUDES WAIVER OF FULL READING OF THE ORDINANCE.

Recommendation: Waive reading of all Ordinances.

- B.2. MINUTES - SPECIAL MEETING OF MAR 14, 2017 (See A.2)

Recommendation: Approve as submitted.

- B.3. MINUTES - STUDY SESSION MEETING OF MAR 14, 2017 (See A.3)

Recommendation: Approve as submitted.

- B.4. MINUTES - STUDY SESSION MEETING OF MAR 28, 2017 (See A.4)

Recommendation: Approve as submitted.

- B.5. MINUTES - SPECIAL MEETING OF MAR 30, 2017 (See A.5)

Recommendation: Approve as submitted.

B.6. MINUTES - SPECIAL MEETING OF APR 11, 2017 (See A.6)

Recommendation: Approve as submitted.

B.7. MINUTES - SPECIAL MEETING OF JUN 13, 2017 (See A.7)

Recommendation: Approve as submitted.

B.8. MINUTES - SPECIAL MEETING OF JUN 16, 2017 (See A.8)

Recommendation: Approve as submitted.

C. CONSENT CALENDAR - HOUSING AUTHORITY

C.1. ORDINANCES - READING BY TITLE ONLY - THE MOTION TO ADOPT AN ORDINANCE LISTED ON THE CONSENT CALENDAR INCLUDES WAIVER OF FULL READING OF THE ORDINANCE.

Recommendation: Waive reading of all Ordinances.

C.2. MINUTES - SPECIAL MEETING OF MAR 14, 2017 (See A.2)

Recommendation: Approve as submitted.

C.3. MINUTES - STUDY SESSION MEETING OF MAR 14, 2017 (See A.3)

Recommendation: Approve as submitted.

C.4. MINUTES - STUDY SESSION MEETING OF MAR 28, 2017 (See A.4)

Recommendation: Approve as submitted.

C.5. MINUTES - SPECIAL MEETING OF MAR 30, 2017 (See A.5)

Recommendation: Approve as submitted.

C.6. MINUTES - SPECIAL MEETING OF APR 11, 2017 (See A.6)

Recommendation: Approve as submitted.

C.7. MINUTES - SPECIAL MEETING OF JUN 13, 2017 (See A.7)

Recommendation: Approve as submitted.

C.8. MINUTES - SPECIAL MEETING OF JUN 16, 2017 (See A.8)

Recommendation: Approve as submitted.

D. CONSENT CALENDAR - BOARD OF LIBRARY TRUSTEES

- D.1. ORDINANCES - READING BY TITLE ONLY - THE MOTION TO ADOPT AN ORDINANCE LISTED ON THE CONSENT CALENDAR INCLUDES WAIVER OF FULL READING OF THE ORDINANCE.

Recommendation: Waive reading of all Ordinances.

- D.2. MINUTES - SPECIAL MEETING OF MAR 14, 2017 (See A.2)

Recommendation: Approve as submitted.

- D.3. MINUTES - STUDY SESSION MEETING OF MAR 14, 2017 (See A.3)

Recommendation: Approve as submitted.

- D.4. MINUTES - STUDY SESSION MEETING OF MAR 28, 2017 (See A.4)

Recommendation: Approve as submitted.

- D.5. MINUTES - SPECIAL MEETING OF MAR 30, 2017 (See A.5)

Recommendation: Approve as submitted.

- D.6. MINUTES - SPECIAL MEETING OF APR 11, 2017 (See A.6)

Recommendation: Approve as submitted.

- D.7. MINUTES - SPECIAL MEETING OF JUN 13, 2017 (See A.7)

Recommendation: Approve as submitted.

- D.8. MINUTES - SPECIAL MEETING OF JUN 16, 2017 (See A.8)

Recommendation: Approve as submitted.

E. PUBLIC HEARINGS

- E.1. PUBLIC HEARING FOR TWO NATIONAL POLLUTANT DISCHARGE ELIMINATION SYSTEM MAIL BALLOT PROCEEDINGS (Report of: Public Works)

Recommendations: That the City Council:

1. Conduct the Public Hearing and accept public testimony for the mail ballot proceedings for Moreno Valley Gateway and Brodiaea Industrial Center to approve the National Pollutant Discharge

Elimination System (NPDES) maximum commercial/industrial regulatory rate to be applied to the property tax bill(s).

- 2. Direct the City Clerk to count the returned NPDES ballots.

| | |
|------------------|---|
| RESULT: | APPROVED [UNANIMOUS] |
| MOVER: | Jeffrey J. Giba, Council Member |
| SECONDER: | Victoria Baca, Mayor Pro Tem |
| AYES: | Cabrera, Gutierrez, Giba, Marquez, Baca |

- 3. Verify and accept the results of the mail ballot proceedings as maintained by the City Clerk on the Official Tally Sheet.
- 4. Receive and file the Official Tally Sheet with the City Clerk’s office.
- 5. If approved, authorize and impose the NPDES maximum commercial/industrial regulatory rate to the Assessor’s Parcel Numbers mentioned in this report.

| | |
|------------------|---|
| RESULT: | APPROVED [UNANIMOUS] |
| MOVER: | Jeffrey J. Giba, Council Member |
| SECONDER: | David Marquez, Council Member |
| AYES: | Cabrera, Gutierrez, Giba, Marquez, Baca |

F. ITEMS REMOVED FROM CONSENT CALENDARS FOR DISCUSSION OR SEPARATE ACTION

- F.1. Item A.14. (F.1) RESOLUTION EXTENDING ORDINANCE 916 BANNING ALL COMMERCIAL CANNABIS ACTIVITY IN THE CITY (Report of: City Attorney) was Continued to the October 24, 2017 Council Meeting.

G. GENERAL BUSINESS

- G.1. PROPOSED LEGISLATIVE ADVOCACY PLATFORM - 2018 (Report of: City Manager)

Recommendation:

- 1. Approve the proposed City Legislative Platform for 2018.

| | |
|------------------|---|
| RESULT: | APPROVED [3 TO 1] |
| MOVER: | Victoria Baca, Mayor Pro Tem |
| SECONDER: | Ulises Cabrera, Council Member |
| AYES: | Ulises Cabrera, Dr. Yxstian A. Gutierrez, Victoria Baca |
| NAYS: | Jeffrey J. Giba |
| ABSTAIN: | David Marquez |

Minutes Acceptance: Minutes of Oct 17, 2017 6:00 PM (CONSENT CALENDAR-CITY COUNCIL)

Keri Then

1. The physical impact for the Legislative Platform on the citizenry is dramatic. Requested agenda item to be delayed to inform the citizens of increased fees by the State.

G.2. RESOLUTION AMENDING COUNCIL MEETING RULES OF PROCEDURE
CONFLICT OF INTEREST SECTION 5.5.5 (Report of: City Attorney)

Recommendations: That the City Council:

Adopt Resolution 2017-54 – which would delete subsections 5.5.5.4 (campaign contribution disclosure) and 5.5.5.5 (governmental entity employment disclosure) from the Rules of Procedure.

| | |
|------------------|---|
| RESULT: | APPROVED [3 TO 1] |
| MOVER: | Victoria Baca, Mayor Pro Tem |
| SECONDER: | Ulises Cabrera, Council Member |
| AYES: | Ulises Cabrera, Dr. Yxstian A. Gutierrez, Victoria Baca |
| NAYS: | Jeffrey J. Giba |
| ABSTAIN: | David Marquez |

Kaira Pacheo

1. Supports the existing Rules of Procedure for the City Council.

Keri Then

1. Supports the current resolution of City Council Meeting Rules of Procedure.

LaDonna Jempson

1. Co-author of the conflict of interest resolution.
2. Intent of resolution was to provide resident with inclusion and transparency.

Rafael Brugueras

1. Campaign contributions and viewing of Form 460's for a purpose and message.

Bob Palomarez

1. City of Moreno Valley went through a corruption scandal that affected the City.

Louise Palomarez

1. Recalled past recall efforts of Moreno Valley officials.

H. REPORTS**H.1. CITY COUNCIL REPORTS ON REGIONAL ACTIVITIES**March Joint Powers Commission (JPC)

Mayor Gutierrez provided a brief update of items covered at the WRCOG Executive Committee meeting on October 2, 2017 as follows:

- Approved the transfer of about 110 acres in the West March Business Park for the UPS Parcel Delivery Terminal and
- We approved the West Meridian Lower Plateau project, which will be developed north and south of an extension for Cactus that goes west toward Riverside. This 130-acre project is primarily industrial, with some business park and a small amount of mixed use.

Riverside County Habitat Conservation Agency (RCHCA)

Council Member Marquez provided a brief update of items covered at the RCHCA Agency meeting on September 21, 2017 as follows:

- Stephens Kangaroo Rat fees for Moreno Valley through June 2017 are \$105,370 or 13.4% of the total fees collected.
- The RCHCA Board approved an agreement for Southern California Edison to convey Stephens Kangaroo Rat incidental take authorization for the Serrano-Valley Transmission Line Project. The line is proposed to traverse through the cities of Perris and Menifee.

Riverside County Transportation Commission (RCTC)

Mayor Pro Tem Baca provided a brief update of items covered at the RCTC Meeting October 11, 2017 as follows:

- The October 10 meeting, the Board approved an overall procurement strategy to accelerate the Riverside County Transportation Efficiency Corridor, which includes a project to construct new tolled express lane connectors from the 91 Express Lanes to north of Interstate 15. Funding for this project, as required by SB 132, must be spent by June 30, 2023. To meet this aggressive schedule, the project will be delivered through a series of contract amendments to existing contracts with engineering companies, contractors, toll vendors, legal and financial advisors.

Riverside Transit Agency (RTA)

Council Member Marquez provided a brief update of items covered at the RTA Meeting on September 28, 2017 as follows:

- The Riverside Transit Agency, as in past years, will be offering free bus rides on New Year's Eve to support those that have to work that evening and to provide an alternative mode of travel for those that may have had too much to drink. The free service will begin on December 31 from 2:30 p.m. until the end of the bus schedule for each particular route.

Western Riverside Council of Governments (WRCOG)

Mayor Gutierrez provided a brief update of items covered at the WRCOG Executive Committee meeting on October 2, 2017 as follows:

- The Western Riverside Energy Partnership announced the 4th Annual LED Holiday Light Exchange and Energy Efficiency starter kit give-away where SCE/SoCal Gas customers can exchange old incandescent string lights for new energy-efficient LED holiday lights at no cost. A give-away will occur on December 9th at the Moreno Valley Snow Day and Holiday Tree Lighting ceremony.
- WRCOG will enter into an agreement with PlaceWorks consulting to perform a feasibility analysis for EXPERIENCE, a sustainability demonstration center. The intent of EXPERIENCE is to showcase the strides inland southern California has made towards achieving a more sustainable quality of life, and to empower visitors to institute more sustainable practices into their homes, schools, and businesses.
- WRCOG is finalizing several documents related to the implementation of the TUMF Program, including an updated Fee Calculation Handbook and TUMF Reimbursement Manual. Both documents will be reviewed and approved by WRCOG Committees before the end of the year.

Western Riverside County Regional Conservation Authority (RCA) - None

School District/City Joint Task Force

Mayor Pro Tem Baca provided a brief update of items covered at the School District/City Joint Task Force meeting on October 17, 2017 as follows:

- Lake Perris shared that up to 3,000 people may attend the One Love Music and Art Festival there this weekend. Other upcoming activities include Lake Perris' annual Lights on the Lake event scheduled for December 9th and the annual First Day Hike scheduled for January 1st.
- Moreno Valley College shared that the third annual Veterans Scholarship Breakfast is scheduled for November 3rd and the Moreno Valley College Gospel Singers 25-Year Anniversary Celebration will be on November 18th. Also, late class session, an accelerated 8-week program, begins on October 21st.
- Moreno Valley Unified School District shared that Anti-Bullying Parent Workshops have been scheduled at every elementary school. The District is partnering with THINK Together for the second year of the Middle School Sports Program which provides basketball and soccer for boys and girls at six (6) middle schools. The District is also seeking volunteers for its Citizens Oversight Committee.

Southern California Association of Governments (SCAG)

Council Member Giba provided a brief update of items covered at the SCAG Executive Regional Meeting on October 5, 2017 as follows:

- Transportation Committee passed a resolution of 17593 regarding Augmented Regional Transportation Program.
- Highway 60 Fastlane Grant has support from SCAG and Senator Roth.

H.2. CITY MANAGER'S REPORT

City Manager Dawson stated she had no report at this time. She will provide an update to the Council on the Strategic Plan at their next meeting. City Manager Dawson introduced and welcomed the New Human Resources Director Kathleen Sanchez.

H.3. CITY ATTORNEY'S REPORT – None

CLOSING COMMENTS AND/OR REPORTS OF THE CITY COUNCIL, COMMUNITY SERVICES DISTRICT, CITY AS SUCCESSOR AGENCY FOR THE COMMUNITY REDEVELOPMENT AGENCY, HOUSING AUTHORITY AND THE BOARD OF LIBRARY TRUSTEES.

Council Member Giba

1. Shared calendared events: International Walk to School Day, CBU Alumni Ribbon Cutting, etc.
2. Hosted Java with Jeff and more events to come to represent and support Moreno Valley.

Council Member Cabrera

1. Thanked Valley View Student Ms. Pacheco for her words and involvement in her political school club.
2. Plans to visit four local high schools. Part of outreach efforts to hear students concerns and dialogue.
3. Construction between Heacock, Gentian and Iris is completed.
4. Announcements of the upcoming Latin Film Festival and Art Walk of local artists.

Council Member Marquez

No closing comments.

Mayor Pro Tem Baca

1. Expressed appreciation for the veto and opposition to AB 890 Bill.

Mayor Gutierrez

1. Expressed thanks to the staff for a successful Business Roundtable.
2. Attended a successful Artober Fest.
3. Grateful for Council Member Cabrera's leadership with the Latin Film Festival and Art Walk.

4. Attended Dr. Steinback's Investiture Ceremony. They also discussed partnership with the Initiative Promise Grant Project.
5. Shared other calendar items past and upcoming.

ADJOURNMENT

There being no further business to come before the City Council, Mayor Gutierrez adjourned the meeting at 7:38 p.m.

Submitted by:

Pat Jacquez-Nares, CMC & CERA, City Clerk
 Secretary, Moreno Valley Community Services District
 Secretary, City as Successor Agency for the Community
 Redevelopment Agency of the City of Moreno Valley
 Secretary, Moreno Valley Housing Authority

Approved by:

Dr. Yxstian Gutierrez, Mayor
 President, Moreno Valley Community Services District
 Chairperson, City as Successor Agency for the Community
 Redevelopment Agency of the City of Moreno Valley
 Chairperson, Moreno Valley Housing Authority



Report to City Council

TO: Mayor and City Council

FROM: Pat Jacquez-Nares, City Clerk

AGENDA DATE: December 19, 2017

TITLE: COUNCIL DISCRETIONARY EXPENDITURE REPORTS FOR FISCAL YEAR 2017/2018 AS OF JULY 1, 2017 THROUGH OCTOBER 31, 2017

RECOMMENDED ACTION

Recommendation:

1. Receive and file the Fiscal Year 2017/2018 Council Discretionary Expenditure Report as of July 1, 2016 through October 31, 2017.

SUMMARY

This staff report is prepared at the request of the City Council to provide transparency with respect to the expenditure of City funds from City Council Discretionary Expenditure Accounts. These reports are for each Council Member's year to date expenditures for Fiscal Year 2017/2018, as of July 1, 2017 through October 31, 2017. Each Council District receives an annual budget allocation of \$3,000 and the Mayor receives an annual budget allocation of \$6,000. The reports include each transaction with a clear description of the expenditure.

These new reports are to be posted to the City's website after Council approval. The reports are also included routinely in the City Council agenda as an additional means of distributing the report to the Council and public. Since the reports are reconciled to the City's general ledger, they will be considered audited and final with the completion of the independent audit for FY 2017/18 when completed by Vasquez & Company.

These reports will continue to be provided on a monthly basis, posted to the City's website, and included on the City Council agenda for the first regular meeting of each month. The reports will follow the same cycle, and will appear with the monthly payment register on City Council agendas in the future.

NOTIFICATION

Posting of the agenda as required by the Brown Act.

PREPARATION OF STAFF REPORT

Prepared By:
Angel Migao
Executive Assistant to Mayor/City Council

Department Head Approval:
Pat Jacquez-Nares
City Clerk

CITY COUNCIL GOALS

None

CITY COUNCIL STRATEGIC PRIORITIES

- 1. Economic Development
- 2. Public Safety
- 3. Library
- 4. Infrastructure
- 5. Beautification, Community Engagement, and Quality of Life
- 6. Youth Programs

ATTACHMENTS

- 1. October 2017 Council Discretionary Funds.112217

APPROVALS

| | | |
|-------------------------|-------------------|-------------------|
| Budget Officer Approval | <u>✓ Approved</u> | 12/07/17 2:51 PM |
| City Attorney Approval | <u>✓ Approved</u> | 12/07/17 12:07 PM |
| City Manager Approval | <u>✓ Approved</u> | 12/07/17 3:09 PM |



MAYOR DIFFERENTIAL

Fiscal Year 2017/2018 Council Discretionary Expenditures

Account: 1010-10-01-10010-620130

July 1, 2017 - October 31, 2017

| Date | Amount | Description |
|------------|-------------|--|
| 7/26/2017 | \$ 20.00 | MVCC Wake-Up Moreno Valley |
| 8/19/2017 | \$ 10.00 | Diocese of San Bernardino Event |
| 8/31/2017 | \$ 74.00 | Southwest Airlines to Sacramento LOCC |
| 9/15/2017 | \$ 30.00 | LOCC Riverside County Annual Conference Breakfast Meeting |
| 9/15/2017 | \$ (30.00) | REFUND/CREDIT LOCC Riverside County Annual Conference Breakfast Meeting |
| 10/27/2017 | \$ 30.00 | Third Annual Veterans Scholarship Breakfast |
| | \$ 134.00 | TOTAL Council Discretionary Expenditures for FY 17/18 (Mayor Differential) |
| | \$ 6,000.00 | FY 17/18 Budget Amount |
| | \$ 5,866.00 | FY 17/18 Budget Amount Remaining |

Source: Unaudited financial data from the City's accounting records.

Updated as of: 11/22/17



COUNCIL DISTRICT 1

Fiscal Year 2017/2018 Council Discretionary Expenditures

Account: 1010-10-01-10010-620111

July 1, 2017 - October 31, 2017

| Date | Amount | Description |
|-----------|-------------|---|
| | | No Expenditures to report for July 2017 |
| | | No Expenditures to report for August 2017 |
| 9/8/2017 | \$ 50.00 | Lincoln Club of Riverside County Luncheon |
| 9/15/2017 | \$ 30.00 | LOCC Riverside Division Annual Conference Breakfast Meeting |
| 9/20/2017 | \$ 45.00 | BIA Affordable Housing & Homelessness |
| 9/28/2017 | \$ 65.00 | Libreria Del Pueblo Dinner |
| 9/30/2017 | \$ 659.46 | Sponsorship of Premier Party & Tent for El Grito Event |
| | | No expenditures to report for October 2017 |
| | \$ 849.46 | TOTAL Council Discretionary Expenditures for FY 17/18 |
| | \$ 3,000.00 | FY 17/18 Budget Amount |
| | \$ 2,150.54 | FY 17/18 Budget Amount Remaining |

Source: Unaudited financial data from the City's accounting records.

Updated as of: 11/22/17



COUNCIL DISTRICT 2

Fiscal Year 2017/2018 Council Discretionary Expenditures

Account: 1010-10-01-10010-620112

July 1, 2017 - October 31, 2017

| Date | Amount | Description |
|--|-------------|---|
| No expenditures to report for July 2017 | | |
| 8/1/2017 | \$ 84.24 | La Bamba - Java with Jeff Refreshments |
| 8/25/2017 | \$ 35.00 | March Field Air Museum Paint the Night |
| 8/25/2017 | \$ 60.00 | Lincoln Club of Riverside County Luncheon |
| 9/8/2017 | \$ 50.00 | Lincoln Club of Riverside County Luncheon |
| 9/15/2017 | \$ 30.00 | LOCC Riverside County Annual Conference Breakfast Meeting |
| 9/15/2017 | (\$30.00) | Refund/Credit LOCC Riverside County Annual Conference Breakfast Meeting |
| 9/21/2017 | \$ 25.00 | NAIOP Commerical Real Estate Dev. Association Meeting |
| 9/21/2017 | (\$25.00) | REFUND/CREDIT NAIOP Commerical Real Estate Development Association Mtg. |
| 9/30/2017 | \$ 125.00 | BIA Riverside County Chapter Installation & Awards |
| 9/30/2017 | \$ 270.00 | Southwest Airlines to Sacramento LOCC |
| 10/9/2017 | \$ 65.00 | Military Ball Dinner |
| 10/10/2017 | \$ 125.00 | Riverside County Office of Education 15th Annual Recognition & Luncheon |
| 10/21/2017 | \$ 85.00 | Riverside National Cemetery Support |
| 10/30/2017 | \$ 30.00 | 3rd Annual Veterans Fundraiser Breakfast |
| | <hr/> | |
| | \$ 929.24 | TOTAL Council Discretionary Expenditures for FY 17/18 |
| | \$ 3,000.00 | FY 17/18 Budget Amount |
| | \$ 2,070.76 | FY 17/18 Budget Amount Remaining |

Source: Unaudited financial data from the City's accounting records.

Updated as of: 11/22/17



COUNCIL DISTRICT 3

Fiscal Year 2017/2018 Council Discretionary Expenditures

Account: 1010-10-01-10010-620113

July 1, 2017- October 31, 2017

| Date | Amount | Description |
|------------|-------------|---|
| 8/31/2017 | \$ 30.00 | LOCC Riverside Division Annual Conference Breakfast Meeting |
| 9/8/2017 | \$ 50.00 | Lincoln Club of Riverside County Luncheon |
| 9/27/2017 | \$ 20.00 | MVCC Wake-up Moreno Valley Meeting |
| 10/6/2017 | \$ 200.00 | PhysicalHealth Impairment Program Belt Gaits |
| 10/18/2017 | \$ 85.00 | Honor Our Heroes |
| 10/25/2017 | \$ 20.00 | MVCC Wake-up Moreno Valley Meeting |
| 10/25/2017 | \$ 30.00 | Third Annual Veterans Scholarship Breakfast |
| | <hr/> | |
| | \$ 435.00 | TOTAL Council Discretionary Expenditures for FY 17/18 |
| | \$ 3,000.00 | FY 17/18 Budget Amount |
| | \$ 2,565.00 | FY 17/18 Budget Amount Remaining |

Source: Unaudited financial data from the City's accounting records.

Updated as of: 11/22/17



COUNCIL DISTRICT 4

Fiscal Year 2017/2018 Council Discretionary Expenditures

Account: 1010-10-01-10010-620114

July 1, 2017 - October 31, 2017

| Date | Amount | Description |
|------------|--------------------|---|
| 7/10/2017 | \$ 35.00 | LOCC Riverside County General Membership Meeting |
| 7/31/2017 | \$ 25.00 | 3rd Annual Southern California Procurement and Trade Summit |
| 8/23/2017 | \$ 20.00 | MVCC Wake-Up Moreno Valley |
| 8/31/2017 | \$ 74.00 | Southwest Airlines to LOCC Sacramento |
| 9/9/2017 | \$ 125.00 | Western Science Center - Science Under the Stars Event |
| 9/15/2017 | \$ 30.00 | LOCC Riverside County General Membership Meeting |
| 9/18/2017 | \$ 50.00 | Lincoln Club of Riverside County Luncheon |
| 10/10/2017 | \$ 125.00 | Riverside County Office of Education 15th Annual Recognition & Luncheon |
| 10/13/2017 | \$ 125.00 | BIA Riverside County Installation & Awards |
| 10/21/2017 | \$ 57.92 | March of Flight |
| 10/25/2017 | \$ 20.00 | MVCC Wake-Up Moreno Valley |
| | <u>\$ 686.92</u> | TOTAL Council Discretionary Expenditures for FY 17/18 |
| | \$ 3,000.00 | FY 17/18 Budget Amount |
| | \$ 2,313.08 | FY 17/18 Budget Amount Remaining |

Source: Unaudited financial data from the City's accounting records.

Updated as of: 11/22/17



Report to City Council

TO: Mayor and City Council

FROM: Kathleen Sanchez, Human Resources Director

AGENDA DATE: December 19, 2017

TITLE: LIST OF PERSONNEL CHANGES

RECOMMENDED ACTION

Recommendation:

1. Ratify the list of personnel changes as described.

DISCUSSION

The attached list of personnel changes scheduled since the last City Council meeting are presented for City Council ratification.

Staffing of City positions ensures assignment of highly qualified and trained personnel to achieve Momentum MoVal priorities, objectives and initiatives.

FISCAL IMPACT

All position changes are consistent with appropriations previously approved by the City Council.

PREPARATION OF STAFF REPORT

Prepared By:
Denise Hansen
Executive Assistant

Department Head Approval:
Kathleen M. Sanchez
Human Resources Director

CITY COUNCIL GOALS

None

CITY COUNCIL STRATEGIC PRIORITIES

- 1. Economic Development
- 2. Public Safety
- 3. Library
- 4. Infrastructure
- 5. Beautification, Community Engagement, and Quality of Life
- 6. Youth Programs

ATTACHMENTS

- 1. Personnel Changes 12.19.17

APPROVALS

| | | |
|-------------------------|-------------------|------------------|
| Budget Officer Approval | <u>✓ Approved</u> | 12/04/17 1:27 PM |
| City Attorney Approval | <u>✓ Approved</u> | 12/04/17 1:05 PM |
| City Manager Approval | <u>✓ Approved</u> | 12/07/17 3:07 PM |

**City of Moreno Valley
Personnel Changes
December 19, 2017**

New Hires

Dean Ayer, Management Analyst
Financial & Management Services Department/Moreno Valley Utility Division

Mark Coronado, Maintenance Worker I
Public Works Department/Maintenance & Operations Division

Nancy Noriega, Recycling Specialist
Public Works Department/Maintenance & Operations Division

Kristy Werner, Sr. Permit Technician
Community Development Department/Building & Safety Division

Promotions

None

Transfers

None

Separations

Thomas Baier, Lead Maintenance Worker
Public Works Department/Maintenance & Operations Division



Report to City Council

TO: Mayor and City Council

FROM: Allen Brock, Community Development Director

AGENDA DATE: December 19, 2017

TITLE: AUTHORIZATION TO AWARD PROJECT-RELATED SERVICES AGREEMENTS FOR PLANNING ENTITLEMENT AND PLAN CHECK SERVICES TO MULTIPLE VENDORS

RECOMMENDED ACTION

Recommendations:

1. Approve each Project-Related Services Agreement with Civic Solutions, Inc. and Annealta Group for Planning Entitlement and Plan Check Services.
2. Authorize the City Manager to execute each Project-Related Services Agreement with Civic Solutions, Inc. and Annealta Group, subject to the approval of the City Attorney.
3. Authorize the Chief Financial Officer to approve purchase orders to Civic Solutions, Inc. and Annealta Group up to a maximum of five years from the Agreement effective date with each firm, in accordance with approved terms of the Agreements.
4. Authorize the Chief Financial Officer to make any necessary budget adjustment appropriations related to expenditures and the equal and offsetting revenues.

SUMMARY

This report recommends approval of each Project-Related Services Agreement with various vendors to provide Planning Entitlement and Planning Plan Check services. Firms were selected following the review and rating of proposals submitted to the City. The vendors will augment staff to ensure timely planning entitlement review, planning plan check services warranted prior to issuance of grading and building permits, and field inspections of projects for compliance with planning related conditions of approval

and environmental mitigation activities.

DISCUSSION

The Planning Division has used contract services over the past two years from a single private firm to provide planning entitlement and plan check services. The Division's current purchase authorization under the current contract has been exhausted and the Division wishes to create a broader base of prequalified vendors to continue the augmented staffing service through the remainder of the current fiscal year and beyond.

The Planning Division issued a Request for Proposal (RFP) for planning entitlement and plan check services September 14, 2017 and received six (6) qualifying responses. The RFP allowed firms to submit for all services or a portion of services. The proposals were required to be complete and submitted by October 16, 2017. The following firms submitted responsive proposals:

The Altum Group
Annealta Group
Civic Solutions, Inc.

CSG Consultants Inc.
HR Green California, Inc.
Willdan Engineering

A team of staff evaluators consisting of a Senior Planner and the Planning Official reviewed and rated the proposals. All proposals were evaluated on multiple criteria utilizing a point system including:

- Firms general experience and qualifications, including staffing levels
- Firms experience providing services to similar size jurisdictions and project types
- References
- Proposed approach to project delivery
- Speed of service delivery

Each proposal was evaluated on its individual merit and assessed a point score to determine the most qualified firms. The top two (2) firms were selected as a result of this competitive selection process. They were identified as the most qualified firms to provide the requested services needed to ensure quality customer care to the residents and development community.

The selected firms are:

- Civic Solutions, Inc.
- Annealta Group

Each Agreement will be in effect from the date the City executes the Agreement through June 2018 with the option of four, one-year extensions for potential total length of four and one-half years ending with the Fiscal Year 2021/22. The costs associated with these Agreements are expected to be recovered from fees paid for by project applicants.

ALTERNATIVES

1. Approve and authorize the recommended actions as presented in this report. *This alternate is recommended by staff to achieve professional and timely development services.*
2. Do not approve and authorize the recommended actions in this report. *This alternative is not recommended by staff and would cause delays at all levels of the permitting process for development projects.*

FISCAL IMPACT

These Agreements will not impact the General Fund as they are expected to be fully funded by recovering fees for service paid for by project applicants.

NOTIFICATION

The posting of the Agenda.

PREPARATION OF STAFF REPORT

Prepared By:
Richard Sandzimier
Planning Official

Department Head Approval:
Allen D. Brock
Community Development Director

CITY COUNCIL GOALS

Positive Environment. Create a positive environment for the development of Moreno Valley's future.

Community Image, Neighborhood Pride and Cleanliness. Promote a sense of community pride and foster an excellent image about our City by developing and executing programs which will result in quality development, enhanced neighborhood preservation efforts, including home rehabilitation and neighborhood restoration.

CITY COUNCIL STRATEGIC PRIORITIES

1. Economic Development
2. Public Safety
3. Library
4. Infrastructure
5. Beautification, Community Engagement, and Quality of Life
6. Youth Programs

Objective 1.1: Proactively attract high-quality businesses.

Objective 1.9: Ensure the City's General Plan articulates the vision for how Moreno Valley wants to evolve over time, and provides an orderly and predictable process

through which this vision is developed and implemented, including new attention to economic development, sustainability, public health, and innovation.

Objective 2.1: Reduce crime, the fear of crime, and the perception of crime in the community.

Objective 5.2: Promote the installation and maintenance of cost effective, low maintenance landscape, hardscape and other improvements which create a clean, inviting community.

Objective 5.5: Promote a healthy community and lifestyle.

ATTACHMENTS

- 1. RFP 2018-006 PLANNING PLAN CHECK ENTITLEMENT SERVICES
- 2. Annealta MV Proposal FINAL
- 3. Civic Solutions MorenoValley Proposal FINAL
- 4. Agreement for Project Related Services Annealta
- 5. Agreement for Project Related Services Civic Solutions

APPROVALS

| | | |
|-------------------------|-------------------|------------------|
| Budget Officer Approval | <u>✓ Approved</u> | 11/29/17 2:11 PM |
| City Attorney Approval | <u>✓ Approved</u> | 11/28/17 9:10 AM |
| City Manager Approval | <u>✓ Approved</u> | 12/07/17 2:18 PM |



RFP # 2018-006

CITY OF MORENO VALLEY
REQUEST FOR PROPOSALS FOR
PLANNING

PLAN CHECK AND ENTITLEMENT SERVICES
AS NEEDED BASIS

PROPOSAL SUBMISSION DUE DATE:

OCTOBER 12, 2017
BEFORE 2:00 p.m. (PST)

**REQUEST FOR PROPOSAL
PLANNING – PLAN CHECK AND ENTITLEMENT SERVICES
AS NEEDED BASIS
FOR THE CITY OF MORENO VALLEY**

INVITATION

I. Introduction

The City of Moreno Valley is seeking a highly qualified consultant to provide complete planning plan check services and entitlement services on an **as-needed basis**.

Prospective proposers/bidders may register and download copies of the RFP package and submit proposals electronically (in PDF format) via the City's electronic bidding system located at http://www.moreno-valley.ca.us/rfps/bids_rfps.shtml.

Proposals will be accepted until 2:00 pm on October 12, 2017.

Proposers are solely responsible for “on time” submission of their proposals online. The City will only consider proposals that have been transmitted successfully and have been issued an ebid confirmation number with a time stamp. Transmission of proposals by any other means will not be accepted. Proposers shall be solely responsible to familiarize themselves with online bidding system in order to properly utilize the proposal management system, for ensuring the capability of their computer system to upload the required documents, and for the stability of their internet service to successfully submit their proposals. Failure of the proposers to successfully submit electronic proposals shall be at the proposers' sole risk and no relief will be given for late and/or improperly submitted proposals. Proposers experiencing any technical difficulties with the proposal submission process may contact PlanetBids at (818) 992-1771. Questions of an operational nature may be directed to the City's Purchasing Division at (951) 413-3190. Neither the City nor PlanetBids makes any guarantee as to the timely availability of assistance or any assurance that any given problem will be resolved by the proposal submission deadline.

All **questions** regarding this RFP must be submitted through the electronic bidding system noted above no later than 4:00 pm on **September 29, 2017**.

II. Clarification

For the purposes of clarification, the following terms are to be read to be one and the same:

- “Contractor”, “Vendor”, “Company”, “Bidder”, “Proposer”, “Firm” and “Consultant”.
- “Agreement” and “Contract”.
- “Bid”, “Quote” and “Proposal”.
- “Request for Quote” and “R.F.Q”.
- “Request for Proposal” and “R.F.P.”.

III. Criteria for Potential Bidders

1. Bidders are to provide a statement of qualifications for provision of plan review and plan check services. Bidder shall demonstrate qualifications to review plans and technical studies in conformance with municipal General Plans, zoning ordinance regulations, state planning laws, and California Environmental Quality Act (CEQA) Guidelines and provide documentation of any professional certifications/licenses/degrees.
2. Bidder shall demonstrate qualifications to inspect built projects to verify conformance with established planning conditions of approval and applicable CEQA mitigation measures.
3. Bidder should provide documentation of current similar services provided to other governmental jurisdictions. This should include letters of recommendation from governmental Planning Managers specifying the bidder's professional services provided. A minimum of 2 letters is preferred, but not mandatory.
4. Bidder shall designate an assigned Project Coordinator/Project Manager with responsibilities to include, but not be limited to, liaising with Planning Official or his designee on staffing increases/decreases and project oversight and needs.
5. Bidder shall indicate if any sub-consultants or associates are proposed to be utilized in the provision of these services. All requirements of the Bidder shall apply equally to the sub-consultants or associates. Assignment of any work to an associate or sub-consultant shall be solely at the direction of the City.
6. Contractor shall guarantee plan review/check turnaround time schedule as specified in Section IV., item "D" and "E" (Scope of Work) for new submittals, resubmittals, and requests for accelerated plan review.
7. The City will not accept an open ended hourly fee for all services. Instead, the Bidder is expected to consider Section 3 – Community Development of the City's adopted Schedule of City Fees, Charges and Rates for Fiscal Year 2017-18 (attached) and provide a proposed flat-fee cost for service for those project types and services that are offered to applicant on a fixed fee.
8. Some project types listed in Section 4 of the adopted Fee Schedule are initiated on a Deposit basis; costs are expected to be recovered based on a fully burdened rate. In addition, the City offers to applicants a Time & Materials (T&M) program for large projects approved by the city. These large projects are charged hourly rates only and cover plan check and inspection services. For services tied to deposit-funded entitlement projects and large T&M project types, the Bidder is expected to provide an hourly rate schedule identifying the rates for each classification/level (e.g. Technician, Assistant, Associate, and Senior) of staff that may be assigned to these types of projects.
9. Bidder will provide a cost for accelerated review of plans, for both project types listed in #6 and #7 above, with specification of the accelerated time frame that can be delivered.
10. Bidder will provide hourly cost for attendance at project meetings, including travel time, for any meeting that would exceed the minimum number identified to be covered as described in Section IV., item "D" (Scope of Work).
11. All postage fees to be paid by contractor and included in fee schedule for transportation of plans between City of Moreno Valley and contractor. Bidder shall use overnight delivery service for next day pick up/delivery of projects between City and Bidder.
12. Successful Bidder will be required to provide a monthly detailed accounting of plans reviewed with invoice.

IV. Scope of Work

Proposals shall demonstrate ability of the firm/individuals to provide the following services:

- A. Plan review of architectural site plans, elevations, technical reports, environmental technical studies, landscape plans, subdivision maps and other documentation routinely associated with applications for land use entitlements. Application types will include, but not be limited to: General Plan Amendments; Changes of Zoning; Specific Plans; Conditional Use Permits; Plot Plans; Variances; and Temporary Use and Sign Permit/Programs. The applications would be the full array of land use types (e.g. residential, commercial, office, retail, industrial, business parks, mixed-use). The focus of the reviews will be to evaluate compliance with the City of Moreno Valley General Plan, all local ordinances, and state and federal laws pertaining to planning, zoning, and environmental quality.

For environmental review, it will be important to demonstrate the ability to complete preliminary environmental scoping of the project using the Initial Study Checklist, review of Initial Studies and technical studies, and experience in coordinating the environmental review process with outside agencies.

- B. Plan review of architectural site plans, elevations, technical reports, environmental technical studies, landscape plans, subdivision maps and other documentation routinely submitted to the Planning Division associated with applications for grading, site development and building permits. The plan check requirement will be from a planning and environmental perspective to ensure consistency with the City of Moreno Valley Municipal Zoning Code Development Regulations, Conditions of Approval tied to associated land use entitlement permits, and mitigation measures tied to the development project as part of the underlying California Environmental Quality Act (CEQA) document approved for the development project.
- C. Limited office space at City Hall will likely be available, but is not guaranteed, so the consultant firm must demonstrate ability to provide transportation of plans for the first reviews/check and for all subsequent re-reviews/checks between the City of Moreno Valley Planning Division office and the Consultant's office where the plan check services will be completed in a timely fashion when City Hall space is not available.
- D. **LAND USE ENTITLEMENTS:** The completion of plan review within the expected time frame. Standard first review is expected to be completed in a maximum of fifteen (15) working days from the date the City receives the plans for review. Subsequent reviews are expected to be completed within ten (10) working days from the date the City receives the plans for review. Upon written request from the City, Consultants will also provide expedited plan reviews. Expedited plan reviews will be expected to be completed in a maximum of five (5) working days from the date the City receives the plans for review. Subsequent expedited reviews are expected to be completed within four (4) working days from the date the City receives the plans for review.

There will be required meetings connected with the entitlement review for the project. The meetings include, but are not limited to, Project Review Staff Committee (PRSC) meetings with City Development Services staff which may also include the applicant. Attendance at other coordination meetings, including meetings with outside agencies may be required. For public hearings, attendance at the following public hearing(s) will be required as dictated by City Municipal Code requirements: Director's Hearing; Planning Commission; and City Council meetings.

For purposes of Bidder proposals, the Bidder should assume five (5) project meetings will be required for each entitlement project.

- E. Planning plan checks of grading, site development, landscaping, and building permits: The completion of plan checks within the expected time frame. Standard first review is expected to be completed in a maximum of ten (10) working days from the date the City receives the plans for review. Subsequent reviews are expected within seven (7) working days from the date the City receives the plans for review. Upon written request from the City, Consultants will also provide expedited Planning plan checks. Expedited plan checks will be expected to be provided in a maximum of five (5) working days from the date the City receives the plans. Subsequent expedited plan checks are expected within four (4) working days from the date the City receives the plans for review.
- F. The arrangement and/or attendance at required meetings connected with the plan review of a project.
- G. The submittal of two complete, typed listings of all required plan review/check corrections in the Planning Division's format, which will be provided to the Consultant.
- H. The Consultant shall indicate if they provide electronic plan check services. If requested by the City, Consultant shall provide additional documentation of these services, including sample documents generated by the system and a live demonstration of the service for evaluation by the City.
- I. Inspections of residential, commercial, and industrial sites to ensure Planning Division project interests are met through conformance with the approved plans, documents (e.g. agreements, standard plans, technical details), conditions of approval, and applicable mitigation measures prior to issuance of a Building Final and/or certificate of occupancy.
- I. Excellent customer care working with the public at the counter related to permit intake (when necessary), assigned plan reviews and plan check reviews, and permit issuance (when necessary). The Consultant must adhere to the City's Customer Care Standards (separate attachment in Planet Bids).
- J. Maintain all records related to the plan review(s) and/or plan check review(s) in accordance with established Department file management practice. The Consultant will be responsible for maintaining case files, electronic files, and updates to the City's "Simplicity" case tracking system. The case tracking system is currently used for the completion of project comments and project conditions of approval for plan reviews, and the capabilities are expanding. Experience working with the Accela Civic Platform is desirable.

VI. Contract Term

The City operates on a fiscal year basis, running from July 1st through June 30th of the following calendar year. It is the intent of the City to have a fully executed contract in place by October or November of 2017.

The Contract shall remain in full force and effect for a total period of five (5) years from the date of fully executed Agreement, unless terminated by either party.

VII. Funding Out Clause

It should be noted that multi-year contracts may be continued each fiscal year only after funding appropriations and program approvals have been granted by the City Council of the City of Moreno Valley. In the event that the City Council of the City of Moreno Valley does not grant necessary funding appropriation and/or program approval, then the affected multi-year contract becomes null and void, effective July 1st of the fiscal year for which such approvals have been denied.

VIII. Conflict of Interest

- A. During the term of the Agreement, the Contractor shall not engage in any business or transaction or maintain a financial interest which conflicts, or reasonably might be expected to conflict with, the proper discharge of the Contractor's duties under the Agreement.
- B. Due to the nature of the work in this RFP, the City of Moreno Valley can **not** accept proposals or establish a contract for this work with any Consultant who also provides engineering services to the private sector.

Only those Consultants who submit a proposal and provide Planning Plan Check and Entitlement services **only** to government entities or agencies will be accepted.

IX. Payment Requirements

- A. The Contractor shall submit to the City an original invoice identifying the name of the plans/project and any associated project numbers and the services performed. Each invoice must reference the appropriate Purchase Order number.
- B. The City will review each invoice submitted by the Contractor, along with any accompanying required documentation in order to determine that the Contractor has properly invoiced, documented and executed the required services. Payment is made by the City within 30 days of approval of completed work or approval of delivered product.
- C. Failure to comply with all requirements of this Agreement may result in non-payment for work performed.

X. Reservation of Rights

The City of Moreno Valley reserves the following options:

- A. The right to reject all partial price proposals.
- B. The right to reject any or all price proposals or make no award.
- C. The right to award to more than one vendor.
- D. The right to issue subsequent requests for price proposals.
- E. The right to waive any informality or irregularity in a price proposal process and any price proposals.

XI. Proposal Requirements

Each proposal must contain the following information to be considered complete. Only complete proposals will be evaluated. **Also** see List of Submittals (Letter I, pg. 8 below).

- A. **Introduction:** Proposals shall be submitted electronically in the City's bid management system in PDF format and shall not exceed 20 pages, excluding a cover page and introduction. At a minimum the proposal must contain the following:
- 1) The methodology/approach proposed for the work as defined in the Scope of Work.
 - 2) The name of the proposing firm, including a full mailing address, e-mail, telephone and fax number.
 - 3) The name of the Project Manager, Associates, Plan Checkers or staff that will be assigned to this work.
 - 4) Team Members applicable to this work. The areas of responsibility of each Team Member shall also be listed and resumes are included.
- B. **Qualifications:** The overall capabilities of the consultant's organization should be discussed in this section. Include a brief summary of the firm's history, its recent related experience, top-level management and ability of persons assigned to perform the work. Possession of appropriate licenses and certificates.
- C. **Personnel:** This section must delineate the experience and/or background of the personnel and organizational chart.
- D. **Reference:** List three (3) municipal/governmental agencies for whom comparable services have been performed within the last five years. Include the organization name, mailing address, name and telephone number of the designated contact person and the email address if available.
- E. **Authorization:** This proposal shall be signed by an official authorized to bind the firm to the terms and conditions contained therein, and the proposal shall contain a statement that the same is valid, binding, and capable of acceptance by the City for ninety (90) days from the date of submittal.
- F. **Fee Schedules:** Fee Schedule shall be included which will be valid for at least one (1) year from the effective date of the contract. The schedule of fees to provide the services outlined above shall include (a) the attached fee template (b) plan review on an hourly basis (c) expedited plan review.
- G. **Time Schedules:** List turn-around time (including transportation of plans) or the initial plan review and for each subsequent plan review (re-check). Include availability and turn-around time (including transportation of plans) for expedited plan review and the turn-around time for each subsequent expedited plan review (re-check).
- H. **Transportation of Plans:** Include the method of transportation of plans for the initial plan review as well as for all re-checks, between the City of Moreno Valley **Planning Division** and the Contractor's office where the plan check service will be completed.

I. List of Submittals: All of the following **must** be submitted. Failure to submit any portion of these documents could be cause for rejection of the submitted proposal.

- 1) Non-Collusion Affidavit
- 2) Affidavit of Non-Conviction
- 3) Vendor Information page
- 4) References pages
- 5) Proposal Schedule
- 6) All items listed above in this section

XII. Withdrawal of Proposal

Any Proposal may be withdrawn electronically utilizing the City's bid management system prior to the proposal submission time and date set forth in the Notice Inviting Proposals. The withdrawal of a Proposal shall not in itself prejudice the right of a Proposer to file a new Proposal provided the new Proposal is received before the closing date and time. No Proposal may be withdrawn or changed after the time noted for submission of Proposals, even if the reason is due to the Proposal being compiled from an incomplete set of RFP documents and/or specifications. A Proposer may seek relief of the RFP by submitting a written request to the Purchasing Division (purchasingdivision@moval.org) within five days after the opening of the RFP's. Whether or not to grant a request for withdrawal of an RFP is within the sole discretion of the City. Said written request shall certify all of the following:

- A) A mistake was made.
- B) Specifying in detail how the mistake occurred.
- C) The mistake made the Proposal materially different than he or she intended it to be.
- D) The mistake was made in filling out the RFP and not due to error in judgment or to carelessness in inspecting the site of the work or in reading the specifications (PCC 5101, 5103).

XIII. Proposal Questions

All questions, must be submitted through the City's online bidding system located at: http://www.moreno-valley.ca.us/rfps/bids_rfps.shtml no later than **4:00 pm on September 29, 2017**.

XIV. Instructions for Submittal of Proposal

Proposals, to be entitled for consideration, must be submitted through the City's online bidding system located at: http://www.moreno-valley.ca.us/rfps/bids_rfps.shtml no later than 2:00 pm on October 12, 2017.

XV. Selection Criteria

The City recognizes that price is only one of several criteria to be used in evaluating a product or service. Award of the Contract shall be made to the most responsive and responsible Proposer that best meets the City's specifications and needs, and represents the best overall value for the City. The City is not bound to accept the lowest price proposal. Submitted proposals will be evaluated on the following criteria but such criteria are not inclusive of all that may be considered. The proposal of the top-ranked firms will then be analyzed by the selection panel.

Evaluation is based on: (criteria are listed in order of importance)

- 5% - References
- 10% - Costs of services and any additional fees
- 15% - Comprehension of Scope of Work
- 30% - Ability of Proposer to provide services in a timely fashion as required
- 40% - Qualifications of Firm and proposed staff identified to provide the requested services; ability of company to backfill staff in the event of an unexpected absence or turnover in staff

XVI. Disqualification of Proposal

- A) More than one Proposal from an individual, a firm or partnership, a corporation or an association under the same or different name will not be considered. Reasonable grounds for believing that any Proposer has an interest in more than one Proposal will cause the rejection of all Proposals in which that Proposer is interested.
- B) If there is a reason for believing that collusion exists among the Proposers, none of the participants in such collusion will be considered in awarding a Contract. Proposals in which the prices obviously are unbalanced may be rejected. If the experience or financial background of the Proposer, as a contractor, is inadequate or past performance has been unsatisfactory, his or her Proposal may be rejected.
- C) No Proposal will be accepted from a Proposer who is not fully and properly licensed as a contractor in accordance with the provisions of Chapter 9 of Division 3 of the Business and Professions Code on the date and at the time of the submittal of the Proposal for the work to be done by him or her (B & P 7028.15).
- D) Proposal is from a firm who also provides engineering services to the private sector (See VIII, Letter B above).
- E) Missing or lack of complete required documents.

XVII. Execution of Contract

The Contract shall be signed by the successful Proposers and returned, together with any required documents, within fourteen (14) calendar days from the date of the Notice of Award of Contract. No award shall be considered binding upon the City until the execution of the Contract.

Failure to execute a Contract and file acceptable documents, as required herein shall be just cause for the annulment of the award. The RFP may be re-advertised or negotiated with other top ranked respondents.

XVIII. Insurance Requirements of Successful Bidder

Please see attached insurance requirements.

REQUIRED RFP SUBMITTAL DOCUMENTS

Attachment: RFP 2018-006 PLANNING PLAN CHECK ENTITLEMENT SERVICES (2886 : AUTHORIZATION TO AWARD PROJECT-RELATED

NON-COLLUSION AFFIDAVIT

STATE OF CALIFORNIA)
) SS
COUNTY OF)

(NAME) _____, affiant being first
duly sworn, deposes and says:

That he or she is _____ of
(sole owner, partner or other proper title)
_____ the party making the foregoing Proposal
(Contractor)

that the bid is not made in the interest of, or on behalf of, any undisclosed person, partnership, company, association, organization, or corporation; that the bid is genuine and not collusive or sham; that the bidder has not directly or indirectly induced or solicited any other bidder to put in a false or sham bid, and has not directly or indirectly colluded, conspired, connived, or agreed with any bidder or anyone else to put in a sham bid, or that anyone shall refrain from bidding; that the bidder has not in any manner, directly or indirectly sought by agreement, communication, or conference with anyone to fix the bid price of the bidder or any other bidder, or to fix any overhead, profit, or cost element of the bid price, or of that of any other bidder, or to secure any advantage against the public body awarding the Contract of anyone interested in the proposed contract; that all statements contained in the bid are true; and, further, that the bidder has not, directly or indirectly, submitted his or her bid price or any breakdown thereof, or the contents thereof, or divulged information or data relative thereto, or paid, and will not pay, any fee to any corporation, partnership, company associations, organization, bid depository, or to any member or agent thereof to effectuate a collusive or sham bid (Public Contract Code Section 7106).

Proposer's Name: _____
(print)

Proposer's Address: _____
(print)

Telephone No.: _____

(Signature of Proposer)

(Title)

**All signatures must be notarized.
Attach Notary here.**

Attachment: RFP 2018-006 PLANNING PLAN CHECK ENTITLEMENT SERVICES (2886 : AUTHORIZATION TO AWARD PROJECT-RELATED

AFFIDAVIT OF NON-CONVICTION

I hereby affirm that:

I am the _____ and the duly authorized
(Title)

Representative of the firm of: _____
(Name of Corporation)

Whose address is: _____
_____ And that

I possess the legal authority to make this affidavit on behalf of myself and the firm for which I am acting.

Except as described in paragraph 3 below, neither I nor the above firm, nor to the best of my knowledge, and of its officers, directors, or partners, or any of its employees directory involved in obtaining Contracts with the City have been convicted of, or have plead *nolo contendere* to a charge of, or having during the course of an official investigation or other proceeding admitted in writing or under oath acts or omissions which constitute bribery, attempted bribery, or conspiracy to bribe under the laws of any State of the Federal government (conduct prior to July 1, 1977 is not required to be reported).

State "none" or, as appropriate, list any conviction, plea or admission described in paragraph two above, with the data, court, official, or administrative body; the individuals involved and their position with the firm, and sentence or disposition, if any.

I acknowledge that this affidavit is required to allow the City to make a determination. I acknowledge that, if the representations set forth in the affidavit are not true and correct, the City may terminate ant Contract awarded and may take any other action.

I do solemnly declare and affirm under the penalties of perjury that the contents of this affidavit are true and correct.

Signature: _____ Date: _____

Printed Name _____ Title: _____

Name of firm: _____

Attachment: RFP 2018-006 PLANNING PLAN CHECK ENTITLEMENT SERVICES (2886 : AUTHORIZATION TO AWARD PROJECT-RELATED

VENDOR INFORMATION

A. PROPOSERS COMPANY INFORMATION (print or type)

Company Name: _____

Owner / Manager Name: _____

PO Mailing Address: _____

City: _____ State _____ Zip _____

Remit to Address (if different from PO mailing address)

City: _____ State _____ Zip _____

Web Site: _____

Phone Number: _____

Fax Number: _____

E-mail Address: _____

Incorporated? (mark one) Yes ___ or No ___

Fed. Tax I.D. # or Social # _____

If not a Corporation, are you a Partnership, LLC, Individual or Joint Venture? _____

How many years of relevant experience within the scope of this RFP? _____

I certify that the information given above is accurate and complete; that the Terms and Conditions as issued by the City of Moreno Valley with this Request for Proposal # RLN-08/09-11 have been fully read, understood, and accepted in total; and that I am a duly authorized agent for quoting purposes for the company named above.

(Print Quoting Persons Name) (Title)

(Quoting Persons Signature) (Date)

Attachment: RFP 2018-006 PLANNING PLAN CHECK ENTITLEMENT SERVICES (2886 : AUTHORIZATION TO AWARD PROJECT-RELATED

REFERENCES

List three (3) references that most closely reflect similar projects and work that your company has worked on within the past five (5) years for a Public or Governmental Agency. (Type or Print)

1. Name of Public Agency: _____

Address: _____

City: _____ State: _____ Zip: _____

Contact: _____ Title: _____

Telephone: (____) _____ Email: _____

Service Dates: _____

Brief Summary of Project/Work provided: _____

2. Name of Public Agency: _____

Address: _____

City: _____ State: _____ Zip: _____

Contact: _____ Title: _____

Telephone: (____) _____ Email: _____

Service Dates: _____

Brief Summary of Project/Work provided: _____

3. Name of Public Agency: _____
Address: _____
City: _____ State: _____ Zip: _____
Contact: _____ Title: _____
Telephone: (____) _____ Email: _____
Service Dates: _____
Brief Summary of Project/Work provided: _____

Attachment: RFP 2018-006 PLANNING PLAN CHECK ENTITLEMENT SERVICES (2886 : AUTHORIZATION TO AWARD PROJECT-RELATED



ANNEALTA GROUP

PROPOSAL FOR

Plan Check and Entitlement Services As Needed Basis

RFP #2018-006

PREPARED FOR

City of Moreno Valley

Rick Sandzimier, Planning Official
City of Moreno Valley
14177 Frederick St.
Moreno Valley, CA 92552

SUBMITTED BY

ANNEALTA GROUP

Tim D'Zmura, PE, CBO, AICP – President/CEO
tdzmura@annealtagroup.com
714.625.5840
www.annealtagroup.com

Attachment: Annealta MV Proposal FINAL (2886 : AUTHORIZATION TO AWARD PROJECT-RELATED SERVICES AGREEMENTS FOR



INTRODUCTION

October 12, 2017

Rick Sandzimier, Planning Official
 City of Moreno Valley
 14177 Frederick St.
 Moreno Valley, CA 92552

**Re: Proposal for Plan Check and Entitlement Services As Needed Basis
 RFP #2018-006**

Dear Rick,

Annealta Group is pleased to submit our proposal for Proposal for Plan Check and Entitlement Services, As Needed Basis, to support the Planning Division of the City of Moreno Valley. We have carefully assembled a team of experienced and professional staff who possess the know-how and skill set to serve as an extension of the City's staff in performing a variety of current planning services on an as needed basis.

Annealta's unique combination of qualifications, experience and certifications will enable us to work effectively with the Planning Division as well as other city departments in the successful review and processing of development projects for the City. Our business formed in response to our client demands for focused services provided by smaller, principal led firms as opposed to untailored services provided by some larger corporations in the market place. Our staff has a proven track record of providing professional reviews and effectively coordinating with other city departments as projects dictate.

Annealta Group focuses on providing the expertise needed to assist our clients with professional services tailored to their specific needs. Spanning critical municipal service areas including public works, city engineering, planning and building and safety, our team of experts bring a wealth of expertise in their respective fields. Serving in the capacity as an extension of our client's staff, we are committed to achieving your organization's goals and overcoming challenges that many assignments encounter. Our client references can attest to our successful track record of the delivery of services and projects on time and within budget in a customer friendly manner!

We understand that the City of Moreno Valley is seeking a highly qualified consultant to provide complete planning plan check services and entitlement services on an as-needed basis. We also understand the importance of performing all work for the City in accordance with the Customer Service Standards set forth in the Momentum MoVal 2016 Strategic Plan Report. We pride ourselves in providing professional, timely and customer friendly services that are tailored to our clients needs.



ANNEALTA GROUP

We proudly **only** serve government entities and, therefore, have no real or perceived conflicts providing the services requested. Additionally, we are currently approved and under contract with the City of Moreno Valley to provide On Call Construction Management and Peer Review Plan Check Services.

We view the keys to serving the City of Moreno Valley as follows:

- ✓ *Assigning experienced, qualified staff to ensure project reviews are conducted efficiently and effectively*
- ✓ *Investing the time and commitment in reviewing and learning the key issues on every assigned project*
- ✓ *Being sensitive to and incorporating into our business methods, Moreno Valley's policies and procedures*

Our contact information is as follows:

ANNEALTA GROUP
 4952 Warner Avenue, Ste 227
 Huntington Beach, CA 92649
Contact: Tim D'Zmura
tdzmura@annealtagroup.com
714.625.5840

As required in the RFP, Mr. D'Zmura is authorized to bind the firm to the terms and conditions contained herein. Also, this proposal is valid for a period of 90 days. We greatly appreciate this opportunity to present our proposal for your consideration. Please don't hesitate to contact me directly if you if you have any questions or would like additional information about how we can assist.

Sincerely,



Tim D'Zmura, PE, CBO, AICP
 President/CEO



Table of Contents

Introduction

Qualifications 1

Scope of Services & Methodology/Approach 4

 Time Schedules 8

 Transportation of Plans 9

Personnel 9

References 13

Fee Schedules (under separate cover) 14

Appendix

 Reference Letters

 Resumes

 Required Forms

Attachment: Annealta MV Proposal FINAL (2886 : AUTHORIZATION TO AWARD PROJECT-RELATED SERVICES AGREEMENTS FOR



QUALIFICATIONS

Firm Background & Experience

Annealta Group focuses on providing the expertise needed to assist our clients with delivering projects on time and within budget. Spanning critical municipal service areas including public works, city engineering, planning and building and safety, our team of experts bring a wealth of expertise in their respective fields. Serving in the capacity as an extension of our client's staff, we are committed to achieving your organization's goals and overcoming challenges that many projects encounter. Our client references can attest to our successful track record of the delivery of services and projects on time and within budget in a customer friendly manner.

We provide the following services to cities/counties:

- ✓ **Program Management**
- ✓ **Project Management**
- ✓ **Construction Management**
- ✓ **Construction Inspection**
- ✓ **Planning**
- ✓ **Building Inspection**
- ✓ **Plan Review**
- ✓ **Organizational Assessments**



Annealta Group's Strengths

Today's development environment can place increased demands on city staffing resources. Annealta Group can help alleviate or minimize this staffing resource burden and at the same time provide a high level of customer service in a budget friendly manner and we possess the ability to adjust service levels as needed. We fully understand these resource demands, have experience in successfully providing services under these conditions and are committed to working for you and the residents of the City.

We propose to provide the City the following fundamental elements:

- ✓ **Customer service.** One of the keys to the success of your department is providing your customers (residents, architects, engineers, contractors) with excellent service. We are committed to providing a level of service to you and your constituents that will meet or exceed your expectations.
- ✓ **Tailored, City-specific services.** We deliver skilled and thorough planning services. Experienced staff will be assigned to projects that possess both the technical know-how and communication skills necessary to effectively process projects according to City policies and procedures.
- ✓ **Effective Coordination with other City Departments.** We are proud of our staff's track record of effectively communicating and coordinating with other City divisions and departments. We understand the one stop shop approach to providing a high level of service to residents and developers alike.
- ✓ **Project Controls.** The services we provide are always closely coordinated and monitored to ensure we meet or exceed the service levels desired by the City, but also stay within the financial capacity of your operating budget. We have broad experience and "hands on" knowledge of municipal budgeting, specifically related to expenditures and cost recovery associated with private development processing and permitting. We will work in close partnership with the City, tailoring our services and deployment of staff to match the allocated budget.



We understand that as needs arise, the City will contact consultant(s) to respond to a detailed request and provide a specific staffing candidate and cost. Based on the City’s request, we will propose the best suited staff that has the skill set aligned with the critical aspects of the specific need. Staff proposed will be experienced at working in a municipal environment, nurturing positive relationships with affected parties, and collaborating with both internal and external stakeholders to deliver the project on time and within budget. Of critical importance will be the assigned staff’s ability to effectively communicate project issues to the City Project Managers and Directors to avoid any surprises on the project.

Annealta’s staff strengths are:

- ✓ *Track record of delivering projects on time and within budget*
- ✓ *Small firm commitment to getting the job done right*
- ✓ *Transparent and ethical methods for delivery of services*
- ✓ *A hands-on principal*
- ✓ *Unique experience collaborating with internal departments to assist in problem solving and project delivery*



Representative Work

Our staff has significant and relevant experience in serving municipalities on a wide-range of assignments in a variety of roles. Our unique experience, including serving in the management roles of Planning Director, Public Works Director, City Engineer, Building Official, provides us a different perspective that aids us in the successful delivery of projects to our clients. Below are some samples of staff’s specific project experience in similar roles:

City of Industry – Planning Staff Augmentation Services

Annealta Group provides a variety of planning services to assist Industry in the review of new development projects and special programs. Specifically, we assist the City by providing two, full time staff members, an Associate Planner and an Assistant Planner, serving as extension of the City’s in-house planning staff. Annealta staff provide counter and phone planning assistance, current planning consultations, design

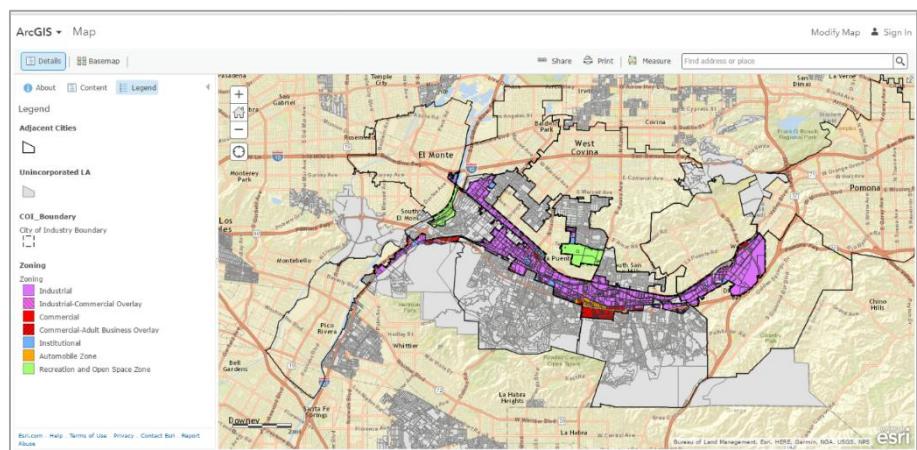

review, processing of site development review applications, sign regulation, variances, CUPs, coordination of CEQA/NEPA preparation, Planning Commission and City Council staff report preparation. Staff also developed this ArcGIS interactive zoning map for the city.

Attachment: Annealta MV Proposal FINAL (2886 : AUTHORIZATION TO AWARD PROJECT-RELATED SERVICES AGREEMENTS FOR



City of Upland –Planning Manager Services

Jerry Guarracino provides a variety of planning services to assist the City in the review of new development projects and special programs. Specifically, he assists the City with the following tasks: Current planning as outlined in Title 17 of the municipal code including design review, site development review applications, sign regulation, variances, CUPs, historic preservation, coordination of CEQA/NEPA preparation, Planning Commission and City Council staff report preparation and attendance at Planning Commission meetings.

| PC No. | Submittal Date | Due Date | Status | Completion Date | Planning Case No. | Assigned To | Address | Project Description | Comments |
|----------|----------------|----------|--------|-----------------|-------------------|-------------|--------------------------|--------------------------|--|
| 15-189 | 03/20/14 | 02/11/14 | A | 2/11/14 | N/A | JW | 188 Van Ness Avenue | Guest House | Completed about 1/4 in Living Room, JS. Sink in living room is Permitted Via 17.19.050 N. JW |
| 15-484 | 09/15/15 | 12/30/15 | DWC | | CUP-13-07 | JW | 1251 W 29th | Verizon Cell Site | |
| 15-519 | 11/02/15 | | DWC | 11/28/15 | | AMP | 247 N. 2nd | Paules | With Corrections |
| 15-680 | 11/04/15 | | A | 10/21/15 | | AMP | 181 S. 17th | Signet | |
| 15-680 | 01/20/16 | 02/18/16 | P | | N/A | SM | 2062 N. Euclid Ave | Second Unit | Issued Corrections 11/24 / See letter from applicant Received 2-2-16 |
| 15-763 | 09/29/15 | | DWC | | | JW | 400 E. 20th | Cell Site | |
| 15-789 | 10/06/15 | | A | 11/9/15 | | AMP | 1206 N. Campbell | Cell Site | |
| 15-791.1 | 09/13/15 | | DWC | | | JW | 2199 W Arrow Rte | Cell Site | Issued Corrections 11/30 |
| 15-791.2 | 01/13/16 | 01/28/16 | A | 1/28/15 | | JW | 2199 W Arrow Rte | Cell Site | Approved 1/28/15 |
| 15-800 | 09/13/15 | | A | 10/08/15 | | CB | 1945 Capistrano | Request Valueria | |
| 15-819 | 11/04/15 | 12/14/15 | P | 1/6/16 | TR 18249 | SI | DWC foothill/Monte Vista | Pool/Rec @ Harvest | corrections required updated B&S computer and permits plus |
| 15-821.1 | 11/02/15 | | P | | | | 1623 N. Mountain | Cell Site | |
| 15-821.2 | 10/29/15 | 12/14/15 | DWC | | CUP-14-17 | JW | 1623 N. Mountain | Verizon Cell Tower | See CUP 14-17 |
| 15-821.3 | 01/12/16 | 02/26/16 | A | 1/26/16 | CUP-14-17 | JW | 1623 N. Mountain | Verizon Cell Tower | See CUP 14-17 |
| 15-847 | 11/04/15 | 12/14/15 | P | 12/9/15 | | JW | 1206 E. Southhill Blvd | Verizon TV Run Fiber | |
| 15-857 | 11/12/15 | 12/14/15 | DWC | 12/14/15 | | AMP | 1282 N. Euclid Ave | Residential Addition | Resubmitted |
| 15-868 | 11/02/15 | 12/14/15 | DWC | | | JW | 1529 Howland Access Road | Verizon Cell Tower | Resubmitted |
| 15-889 | 02/04/16 | 02/17/16 | P | | | JW | 370 Harvey Avenue | Guest House | Resubmitted See attached comments |
| 15-882 | 11/18/15 | 12/16/15 | DWC | | CUP-15-05 | CB | 814 N. Central Ave | 3rd Base Sports Bar | to applicant to submit security plan |
| 15-881 | 12/03/15 | 12/30/15 | P | | DR-15-16 | CB | 1301 San Bernardino Road | Sycamore Terrace Remodel | |

City of Cypress – Staff Augmentation Support Services for Planning and Public Works

Tim D’Zmura, and various support staff, provide a variety of planning and public works services to assist the City in the review of new development projects and implementation of special projects. As a member of the City’s on call planning consultant team, Annealta has prepared and IS/MND for a proposed Self-Storage Project on Valley View Street. Public Works on call services have included project management for the Annual Concrete Rehabilitation Project \$400K and the City Hall HVAC Upgrade Project \$300K.

City of Costa Mesa- Interim Assist Director, Economic and Development Services

Jerry Guarracino managed an eight-member Planning Department serving a dynamic city of 112,000 people. His responsibilities included:

- ✓ Administer the General Plan Consultant’s contract; including setting up a financial tracing system linked to accomplished project tasks.
- ✓ Review and preparation of Planning Commission Agenda’s, and establishing the annual Planning Commission goals for a proactive commission.
- ✓ Implemented an ordinance to limit long-term occupancy at local motels and oversaw comprehensive multi-departmental annual inspection of motel properties resulting in significant improvements in property maintenance standards and management techniques.
- ✓ Implemented an Ordinance to regulate group homes including sober living homes in the City. Since adoption, this groundbreaking Ordinance has been found to be facially valid three times by the Federal District Court.
- ✓ Established a new application process and application materials to implement the Group Home Ordinance.
- ✓ Developed a Data Base and Mapping System to track the City’s more than 300 group homes.

City of Wildomar – Planning, Building & Safety, Public Works Service

Mr. D’Zmura served as the Project Manager for the City and had responsibility for the overall direction of the city public works, engineering, building & safety and planning services as well as capital project delivery. He represented the City in MS4 storm water permit negotiations with the San Diego Regional Water Quality Control Board. He also successfully coordinated and transitioned the management of local capital improvement projects from the County of Riverside to the City of Wildomar drafting and securing approval of the City’s very first funded Capital Improvement Plan.

“Tim has been integral in working with various agencies to coordinate the largest CIP project for the City”
 Council Members
 City of Wildomar Proclamation, 2013

Attachment: Annealta MV Proposal FINAL (2886) : AUTHORIZATION TO AWARD PROJECT-RELATED SERVICES AGREEMENTS FOR



City of Palos Verdes Estates – Planning Director & Building Official

Mr. D'Zmura's principal accomplishments and assignments included:

- ✓ Development of a Pavement Management System
- ✓ Drafted the Soils and Geology Review Process
- ✓ Provided Project Engineering on the Via Zurita Hairpin Turn Roadway Repair Project
- ✓ Management of the Preparation of the Traffic Calming Plan
- ✓ Construction Contract Management
- ✓ Plan Review
- ✓ Capital Improvement Planning and Implementation
- ✓ Guidance on Hillside Development and Grading
- ✓ Roadway and Landscape Maintenance Management
- ✓ Feasibility Studies

SCOPE OF SERVICES & METHODOLOGY/APPROACH

Scope of Services

Our understanding is that the City of Moreno Valley is seeking a highly qualified consultant to provide complete planning plan check services and entitlement services on an as-needed basis. Specific duties may include the following:

- A. Plan review of architectural site plans, elevations, technical reports, environmental technical studies, landscape plans, subdivision maps and other documentation routinely associated with applications for land use entitlements. Application types will include, but not be limited to: General Plan Amendments; Changes of Zoning; Specific Plans; Conditional Use Permits; Plot Plans; Variances; and Temporary Use and Sign Permit/Programs. The applications would be the full array of land use types (e.g. residential, commercial, office, retail, industrial, business parks, mixed-use). The focus of the reviews will be to evaluate compliance with the City of Moreno Valley General Plan, all local ordinances, and state and federal laws pertaining to planning, zoning, and environmental quality.
- B. Plan review of architectural site plans, elevations, technical reports, environmental technical studies, landscape plans, subdivision maps and other documentation routinely submitted to the Planning Division associated with applications for grading, site development and building permits. The plan check requirement will be from a planning and environmental perspective to ensure consistency with the City of Moreno Valley Municipal Zoning Code Development Regulations, Conditions of Approval tied to associated land use entitlement permits, and mitigation measures tied to the development project as part of the underlying California Environmental Quality Act (CEQA) document approved for the development project.
- C. LAND USE ENTITLEMENTS: The completion of plan review within the expected time frame. Standard first review is expected to be completed in a maximum of fifteen (15) working days from the date the City receives the plans for review. Subsequent reviews are expected to be completed within ten (10) working days from the date the City receives the plans for review. Upon written request from the City, Consultants will also provide expedited plan reviews. Expedited plan reviews will be expected to be completed in a maximum of five (5) working days from the date the City receives the plans for review. Subsequent expedited reviews are expected to be completed within four (4) working days from the date the City receives the plans for review.



There will be required meetings connected with the entitlement review for the project. The meetings include, but are not limited to, Project Review Staff Committee (PRSC) meetings with City Development Services staff which may also include the applicant. Attendance at other coordination meetings, including meetings with outside agencies may be required. For public hearings, attendance at the following public hearing(s) will be required as dictated by City Municipal Code requirements: Director's Hearing; Planning Commission; and City Council meetings.

- D. Planning plan checks of grading, site development, landscaping, and building permits: The completion of plan checks within the expected time frame. Standard first review is expected to be completed in a maximum of ten (10) working days from the date the City receives the plans for review. Subsequent reviews are expected within seven (7) working days from the date the City receives the plans for review. Upon written request from the City, Consultants will also provide expedited Planning plan checks. Expedited plan checks will be expected to be provided in a maximum of five (5) working days from the date the City receives the plans. Subsequent expedited plan checks are expected within four (4) working days from the date the City receives the plans for review.
- E. The arrangement and/or attendance at required meetings connected with the plan review of a project.
- F. Inspections of residential, commercial, and industrial sites to ensure Planning Division project interests are met through conformance with the approved plans, documents (e.g. agreements, standard plans, technical details), conditions of approval, and applicable mitigation measures prior to issuance of a Building Final and/or certificate of occupancy.
- G. Maintain all records related to the plan review(s) and/or plan check review(s) in accordance with established Department file management practice. The Consultant will be responsible for maintaining case files, electronic files, and updates to the City's "Simplicity" case tracking system. The case tracking system is currently used for the completion of project comments and project conditions of approval for plan reviews, and the capabilities are expanding.

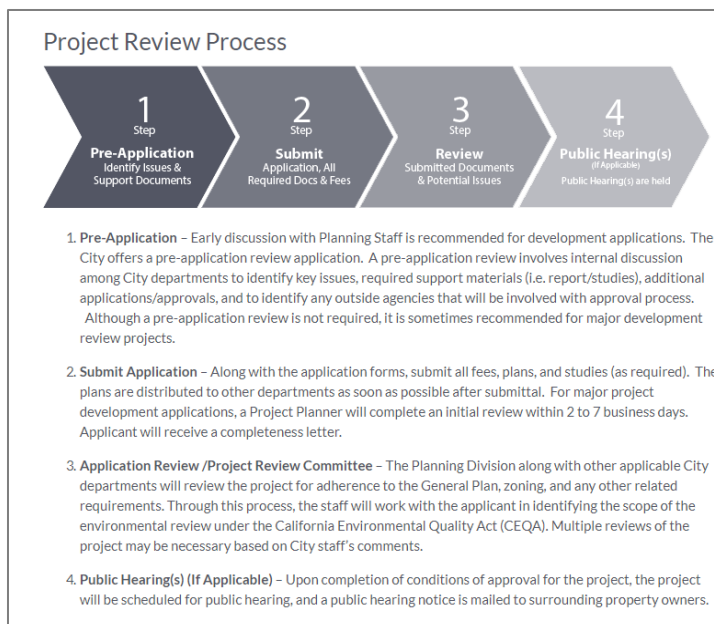

Methodology and Approach

First and foremost, all work will be performed in accordance with the Customer Service Standards set forth in the Momentum MoVal 2016 Strategic Plan Report. Our assigned staff will familiarize themselves with all City documents and plans that provide the framework, policies and guidelines for development. We will pay special attention to the Specific Plans as follows:

Auto Mail

- ✓ SP-209 Amendment No. 3
- ✓ SP-209 Amendment No. 4
- ✓ SP-209 Amendment No. 5

Industrial Area

- ✓ SP-208 Industrial Area

World Logistics Center

- ✓ SP-WLC

The Village

- ✓ SP-204 The Village

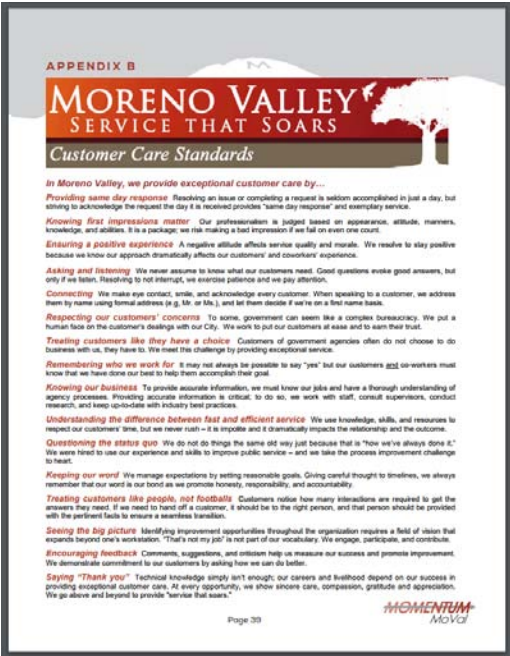

1. Steps for development case processing (Ministerial and Discretionary)

- a. Enter the project into "Simplicity", the City's ACCELA based case tracking system.
- b. Determine whether the development case application is complete by reviewing the project in accordance with applicable specific plans, various design guidelines and sustainability checklists, the City's general plan, zoning code and all pertinent regulations and standards. We will review the site plan, conceptual grading plan, conceptual landscape plan and hardscape plans, building elevations, subdivision map and SUSMP.
- c. Review development case for consistency with applicable development agreements, certified environmental documents and mitigation monitoring programs (MMP)
- d. Prepare a list of incomplete items, technical deficiencies or problems and design issues for the development case.
- e. Conduct an in-house development review meeting consisting of planning staff, other city department staff and affected agencies such as school district and fire department. The purpose of the development meeting is to obtain their comments and feedback and incorporate their comments in to the incompleteness letter/comments as well as to analyze and evaluate the merits of the project.
- f. Prepare meeting notes and provide a copy of the notes to all City's participants.

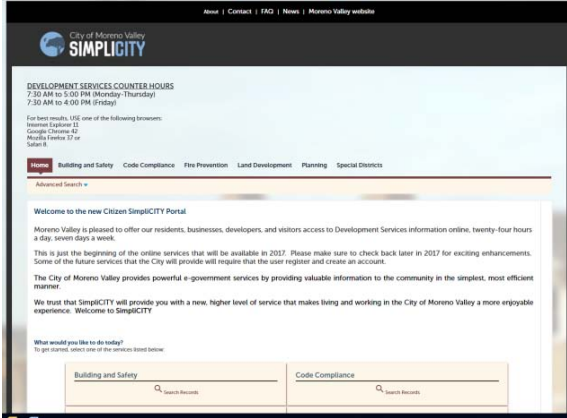

Attachment: Annealta MV Proposal FINAL (2886 : AUTHORIZATION TO AWARD PROJECT-RELATED SERVICES AGREEMENTS FOR



- g. Prepare completeness letter/comments for City’s staff review. Upon approval, send letter/comments to applicant. The completeness or incompleteness determination will comply with the 30 days from the date of the project case submittal.
- h. Arrange meeting with the applicant and staff to review the incompleteness letter/comments. Respond to comments from the applicant.
- i. Review the second round of submittal against the first incompleteness letter/comments. Repeat the review until the development case application is deemed complete for further action.
- j. Upon deeming the development case application complete, prepare an approval letter with the conditions of approval for Community Development Director or his designee for review and signature.

Add the following steps for discretionary cases

- k. Docket development case for Planning Commission meeting. Work with City staff to prepare the draft agenda, the public hearing notice and postings.
- l. Prepare staff report, resolutions and conditions of approval for Community Development Director or his designee for review and approval.
- m. Attend the Planning Commission meeting and present the report. Assist staff to respond to comments from the public pertaining to the specific development case.

| Issue | Solution |
|---|---|
| Keeping the City Project Manager Informed | Establish daily communication protocol and adhere to it throughout the life of the project! |
| Maintaining Positive Community Relations | As directed and authorized by the City, make ourselves available and keep residents & businesses informed in a professional and timely manner when questions are received via email and phone. |
| Coordinating and communicating with other City Departments and outside agencies | Ensure that all city departments – police, fire, utilities, transit, etc. – are informed of the project, its schedule and potential impacts on their services. Continue to inform these critical stakeholders as the project changes. |

2. Administration – steps for successful development case processing Annealta Group will:

- a. Understand the project and will conduct a site visit
- b. Have weekly joint meetings with City’s staff and applicant to review the status of each development case.
- c. Utilize the City’s tracking system for each development case and provide them to applicant
- d. Prepare and submit meeting notes to City’s staff and applicant
- e. Prepare reports that are clear, concise and contain all the facts
- f. Understand the importance of records management. Records will be kept of meetings, phone conversations, when a decision or discussion on certain items has been made, etc.
- g. The project case file will always be up-to-date, complete and organized



3. Electronic Plan Check

Various cities have adopted the process of utilizing Electronic Plan Check. Electronic Plan Check programs enables applicants to submit Portable Document Files (PDF), as an alternative to submitting the required, application, construction drawings, and supportive documentation (i.e. structural calculations, soils reports, water supply tests, etc.) in the traditional paper form. Moving from hard copy review to electronic plan review reduces the turnaround time as well as enhances communication throughout the process. Many cities are utilizing a variety of software programs to adopt this method as a means improve turnaround time and reduce time and cost for the applicant.

Annealta staff is familiar with electronic plan check process and have provided this service for many of our clients. We are proficient using various software applications, including ProjectDox, e-PlanSoft, Bluebeam, Revu, Adobe, TrakiT, SmartGov and NewForma. Utilizing electronic plan check we are able to efficiently manage, track and communicate the plan review comments and approvals in real time with the applicant. When requested, plan reviews will be conducted using the City’s electronic plan check system.

4. Additional on-call planning services

After ministerial or discretionary approval of a development case, the next step is for applicant to submit the project for plan check. It is an important step as the plan check will implement the conditions of approval and ensure the site is developed and constructed according to the plans that were approved by the City’s staff or Planning Commission. In essence, plan check is “quality control.”

- a. Our assigned planner can provide additional planning services in Building and Safety Plan Review and Public Works Design Plan Review for Subdivision Map.
- b. Examples of duties our assigned on-call planner will perform include the following: detailed site plan, grading plan and street improvement plans are in accordance with approved plans and are coordinated for consistency purpose; exterior building elevations and color palette are consistent with the approved elevations; and, detailed landscape plans (private realm) are consistent with the list of native, water-conserving, disease-resistant and low maintenance plant species.

Time Schedules

We take great pride in providing quality customer service to our clients. Our goal is to deliver services in a collaborative and professional manner with applicants, businesses and the development community. Our approach is to advise, guide and assist the community in a helpful and courteous manner as projects vary in complexity. Because we are serving as an extension of city staff our engineers and plan reviewers are continuously focused on delivering efficient and timely plan reviews.

- All plans will be picked up within 24 hours upon notification and delivered back to the city at no cost to the City
- Plan reviews will be performed consistent with the city’s turn-around requirements
- Maintain a high level of customer service to the community

Our staff is committed to city’s turnaround schedule as outlined in the RFP.

| Type of Project | First Review | Subsequent Plan Checks |
|---|-----------------|------------------------|
| Land Use Entitlements | 15 working days | 10 working days |
| Expedited Plan Review | 5 working days | 4 working days |
| Grading, site development, landscaping and building permits | 10 working days | 7 working days |
| Expedited Plan Checks | 5 working days | 4 working days |



If requested, Annealta Group will develop a detailed project schedule for each project specific assignment based on specific milestones. Below is a project sample schedule for a typical assignment.

SAMPLE PROJECT SCHEDULE

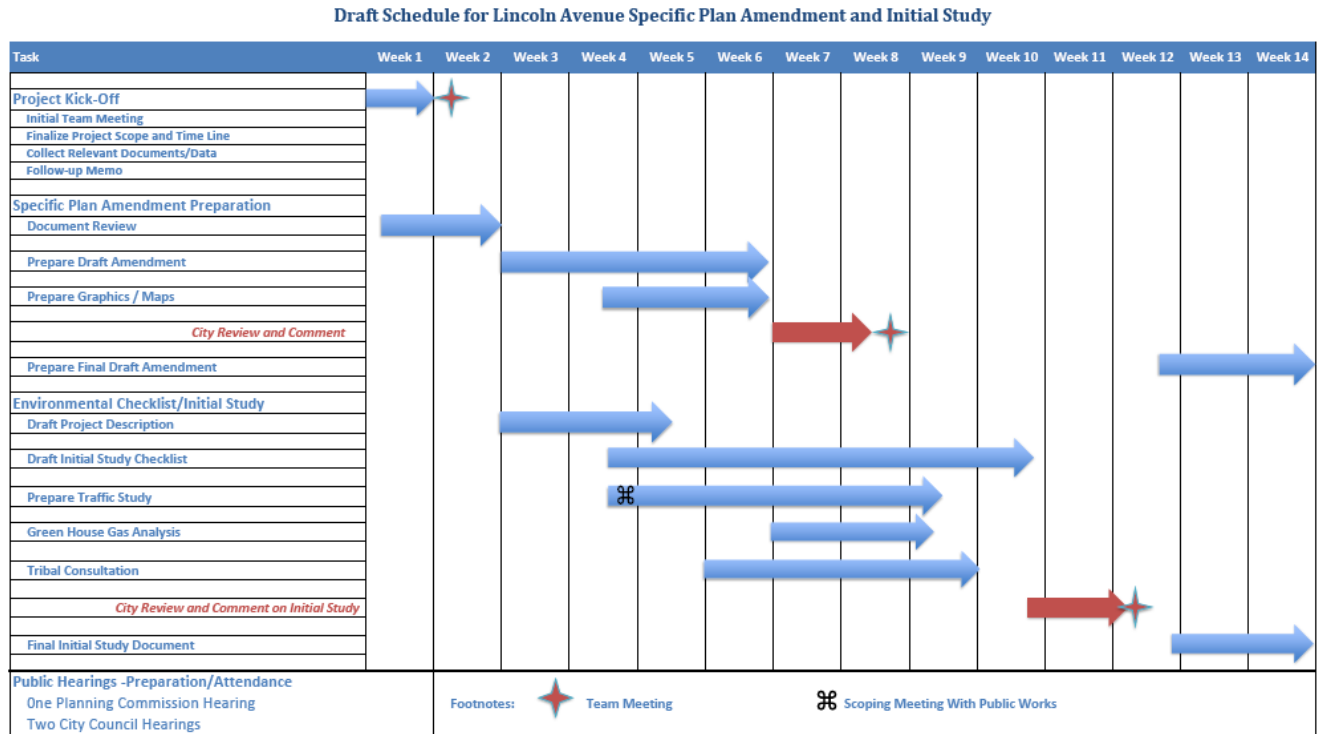

Transportation of Plans

We understand that only limited office space at City Hall will likely be available, and is not guaranteed, so the consultant firm must demonstrate ability to provide transportation of plans for the first reviews/check and for all subsequent re-reviews/checks between the City of Moreno Valley Planning Division office and the Consultant's office.

All plans will be picked up within 24 hours upon notification and delivered back to the city at no cost to the City. Plans shipped back to the city they will be done utilizing our staff, a courier or overnight shipping service to ensure the turnaround times are met.

PERSONNEL



Annealta is pleased to propose the following staff to serve the City. Each individual has been selected based on their experience, expertise and knowledge of municipal project delivery and processes.

Staff proposed is experienced at working in a municipal environment, nurturing positive relationships with affected parties, and collaborating with both internal and external stakeholders to deliver the project on time and within budget. Given the wide range of possible projects, we have included a team of professionals



ready to serve the City depending on the varying workload.

Staff will be assigned based on the City's specific requests and no changes will be made without the City's authorization. We also will make every effort to seek out and hire local residents to fill any role that we are requested to fill at the City.

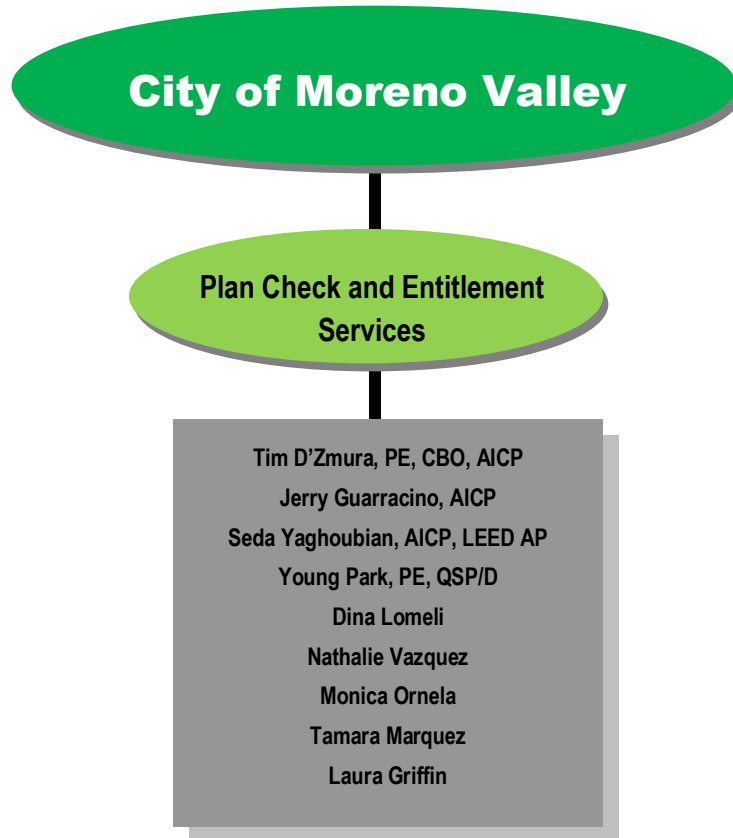

STAFF BIOGRAPHIES

Tim D'Zmura, PE, CBO, AICP | PROJECT MANAGER

Tim brings more than 30 years experience and has served in a number of capacities in the fields of current and advanced planning, civil engineering, municipal public works, and building safety administration and inspection. He has served public sector clients as in-house planning director, public works director, city engineer, assistant city engineer and building official. He has served private sector clients as a project manager and design engineer. In addition, a collaborative working style enables him to bring stakeholders when problems are encountered so solutions may be quickly identified and implemented.

Attachment: Annealta MV Proposal FINAL (2886 : AUTHORIZATION TO AWARD PROJECT-RELATED SERVICES AGREEMENTS FOR



Jerry Guarracino, AICP | SENIOR PLANNER

Jerry brings 25 years of progressive experience as a creative planning manager/urban designer with a broad range of current and advance planning experience, managing multidisciplinary teams in the preparation and review of master plans, specific plans, general plan amendments, design guidelines, feasibility analysis, land use analysis, and CEQA compliance. He brings a wealth of knowledge in processing and project management of specific plans, zoning amendments, conditional use permits, subdivision maps, variances and community relations. His management experience includes economic and community development through CDBG, HOME, and Emergency Shelter Grant Programs.

Seda Yaghoubian, AICP, LEED AP | SENIOR PLANNER

Seda is bi-lingual (Farsi, Armenian, French) with 30 years of experience in municipal and regional planning and project management. During her career as an urban and environmental planner, she has taken leadership roles in numerous large-scale private development and public sector planning and infrastructure projects throughout California, and internationally. She has extensive experience in projects dealing with major land development ventures involving complex development agreements and ownership structures, land use/transportation linkages, Federal Base Realignment and Closure (BRAC) process, CEQA and NEPA analysis, zoning, entitlement and growth management policy development. She has managed numerous community outreach efforts for planning, design and construction phases of municipal and private projects. Her attention to detail and focus on critical compliance issues enables her to successfully deliver extremely complex projects.

Young Park, PE, QSP/D | SENIOR PLANNER

Young brings over 27 years of civil engineering and transportation planning experience and has spent the vast majority of his career serving various jurisdictions in the Southern California region; applying the practices of civil engineering to both private land development and city public works projects. Young is a registered Civil Engineer in the State of California and a certified Qualified SWPPP Practitioner/Developer. His background has provided him with the knowledge of city engineering policies and procedures, which is a proven asset when providing technical assistance to engineers, architects, contractors, city personnel, and the public. Young has a strong work ethic, is detailed oriented, and enjoys both project teamwork and working independently. He is extremely skilled in all disciplines of civil engineering required for the successful completion of projects.

Dina Lomeli | ASSOCIATE PLANNER

Dina is bilingual and fluent in English and Spanish and brings more than ten years of planning/customer service experience in planning and development services. She provides technical planning and support to department staff and the public regarding zoning and General Plan matters and case processing. Her knowledge allows her to effectively and professionally respond to a wide range of inquiries.

Nathalie Vazquez | ASSISTANT PLANNER

Nathalie is bilingual in English and Spanish and has an excellent understanding of the municipal planning process having served as an intern for the City of Santa Ana. Her experience includes a variety of planning activities including the processing of CUPs and technical data management for municipal GIS systems. She possesses excellent communication, presentation and customer service skills.



Monica Ornela | PLANNING TECHNICIAN

Monica is a bi-lingual permit technician with 8 years of comprehensive experience in the building arena. She is customer-oriented, independent and proactive in delivering skilled, professional services to building contractors, architects, engineers and the public. She has experience and is proficient with many permit and land development software programs including Speed Web, EnerGov, Tyler Technologies/Munis and HdL/PrimeCloud. Monica is responsive to both external and internal clients with a friendly, professional approach. She specializes in being able to quickly and successfully adjust to changes in tasks and processes and is very organized in her responsibilities. Her interaction with co-workers at all levels in a jurisdiction is done in a collaborative and professional manner. Monica especially takes to heart performing all her duties within the context of the client's requirements, mission and values. She applies great energy and pride to her work and is an asset to our clients.

Tamara Marquez | PLANNING TECHNICIAN

Tamara is a highly organized and professional permit technician with more than 11 years experience serving a variety of municipal clients. Her skills include front counter and back office duties including: assisting walk-in customers with general inquiries about permit applications, processing payments, and issuing appropriate permits; conducting minor plan check to ensure compliance with building code requirements; routing plans; maintaining the permit tracking system; collecting and recording of fees; creating monthly reports and logs; and routing and tracking plans. She manages the front counter in a friendly and professional manner.

Laura Griffin | PLANNING TECHNICIAN

Laura is an ICC Certified Permit Technician bringing over 16 years of direct experience serving municipalities in southern California. She is also a certified building and combination dwelling inspector making her a multi-faceted and flexible resource to our clients. She possesses the ability to work with a variety of software programs and read detailed construction documents. Laura's extensive training in a wide range of areas combined with her calm leadership, organization style and effective communication skills is what makes the difference to our clients and those she works with.

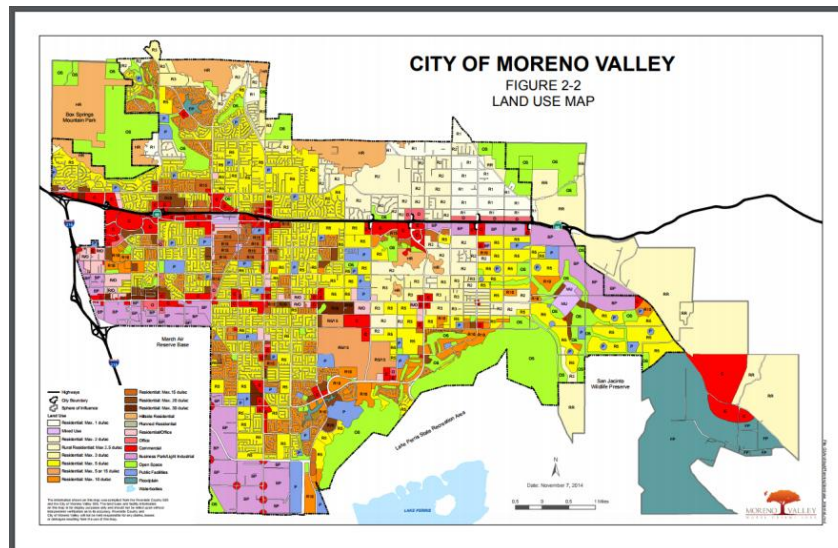

Attachment: Annealta MV Proposal FINAL (2886 : AUTHORIZATION TO AWARD PROJECT-RELATED SERVICES AGREEMENTS FOR



REFERENCES

Our staff has dedicated their careers to serving government agencies in a transparent and ethical manner. The following are examples of our success in the delivery of staffing services. We have also included the “references form” in the appendix as outlined in the RFP.

| | |
|---|---|
| <p>City of Upland</p> <ul style="list-style-type: none"> ✓ Planning ✓ Building & Safety | <p>Jeff Zwack <i>Development Services Director</i> (909) 931-4148 jzwack@ci.upland.ca.us</p> |
| <p>City of Industry</p> <ul style="list-style-type: none"> ✓ Planning ✓ Permit Technician ✓ Development Engineering | <p>Alex Gonzalez <i>Director of Development Services and Administration</i> (626) 333-2211 x108 alex@cityofindustry.org</p> |
| <p>City of Cypress</p> <ul style="list-style-type: none"> ✓ Planning ✓ Public Works | <p>Doug Dancs <i>Director of Community Development</i> (714) 229-6740 DDancs@ci.cypress.ca.us</p> |
| <p>City of Wildomar</p> <ul style="list-style-type: none"> ✓ City Engineering ✓ Planning ✓ Construction Management ✓ Construction Inspection ✓ Public Works Inspection ✓ Building Plan Review ✓ Building Inspection | <p>Frank Oviedo <i>Former City Manager</i> (661) 255-4901 foviedo@santa-clarita.com</p> |

Attachment: Annealta MV Proposal FINAL (2886 : AUTHORIZATION TO AWARD PROJECT-RELATED SERVICES AGREEMENTS FOR



FEE SCHEDULES

Provided under separate cover per the submittal requirements via planetbids

Attachment: Annealta MV Proposal FINAL (2886 : AUTHORIZATION TO AWARD PROJECT-RELATED SERVICES AGREEMENTS FOR



APPENDIX

As outlined in the RFP, included below are the additional items required for submittal

- ✓ **Reference Letter**
- ✓ **Resumes**
- ✓ **City Required Form**





DEVELOPMENT SERVICES DEPARTMENT
OFFICE OF THE DIRECTOR
 Direct Office Telephone (909) 931-4148
 Facsimile (909) 931-4321
 Email jzwack@ci.upland.ca.us

October 4, 2017

Tim D'Zmura, President/CEO
 Annealta Group
 4952 Warner Ave, Ste 227
 Huntington Beach, CA 92649

Re: Letter of Recommendation for Annealta Group

Dear Tim,

Annealta Group has provided contract planning and building and safety services for the City of Upland since 2015. Current assignments include coordinating and performing the review of new development projects and the execution of special programs in the areas of current planning including design review, site development review applications, sign regulation, variances, CUPs, historic preservation, coordination of CEQA/NEPA preparation, Planning Commission and City Council staff report preparation and presentations. In support of the Building Department, the Permit Technician provides front counter support assisting with permit issuance, plan review and customer service. Your staff does an excellent job in serving as an extension of the City's in-house Planning and Building Departments. I have found your company to be very responsive, your services tailored to our needs and your staff to be professional and customer-oriented. I highly recommend Annealta Group to provide contract Planning, Building and other extension of staff services.

Sincerely,

Jeff Zwack
 Development Services Director

Attachment: Annealta MV Proposal FINAL (2886 : AUTHORIZATION TO AWARD PROJECT-RELATED SERVICES AGREEMENTS FOR



CITY OF INDUSTRY

Incorporated June 18, 1957

March 27, 2017

Christine Saunders, Associate Planner
Planning and Building Department
Planning Services Division
200 South Anaheim Boulevard
City of Anaheim, CA 92805

Re: Letter for Recommendation for Annealta Group

Dear Christine,

Annealta Group provides a variety of planning services to assist Industry in the review of new development projects and special programs. Specifically, they assist the City by providing two, full time staff members serving as extension of the City's in house planning staff. Annealta staff provide counter and phone planning assistance, current planning consultations, design review, processing of site development review applications, sign regulation, variances, CUPs, coordination of CEQA/NEPA preparation, Planning Commission and City Council staff report preparation.

The City of Industry has found their services to be professional, thorough and responsive. I have no issue with recommending Annealta Group to provide planning and other services. Please don't hesitate to contact me if you wish to discuss their services further.

Regards,

Alex Gonzalez
Director of Development Services and Administration

Attachment: Annealta MV Proposal FINAL (2886 : AUTHORIZATION TO AWARD PROJECT-RELATED SERVICES AGREEMENTS FOR PLANNING



City of Port Hueneme

Administration

March 27, 2017

Christine Saunders, Associate Planner
 Planning and Building Department
 Planning Services Division
 200 South Anaheim Boulevard
 City of Anaheim, CA 92805

Re: Letter for Recommendation for Annealta Group

Dear Christine:

Annealta Group provides a variety of planning services to assist the City of Upland in the review of new development projects and special programs. Specifically, they assist the City with the following tasks: current planning as outlined in Title 17 of the municipal code including design review, site development review applications, sign regulation, variances, CUPs, historic preservation, coordination of CEQA/NEPA preparation, Planning Commission and City Council staff report preparation. They have performed these services since November 2015.

The City of Upland has found their services to be professional, thorough and responsive. I can confidently recommend the Annealta Group to provide planning and other services. Please don't hesitate to contact me at (805) 986-6501 if you wish to discuss their services further.

Sincerely,

Rod B. Butler (former City Manager of Upland)
 City Manager of Port Hueneme

NON-COLLUSION AFFIDAVIT

STATE OF CALIFORNIA)
COUNTY OF) SS

(NAME) Tim D'Zmura, affiant being first duly sworn, deposes and says:

That he or she is sole owner of Annealta Group (Contractor) the party making the foregoing Proposal

that the bid is not made in the interest of, or on behalf of, any undisclosed person, partnership, company, association, organization, or corporation; that the bid is genuine and not collusive or sham; that the bidder has not directly or indirectly induced or solicited any other bidder to put in a false or sham bid, and has not directly or indirectly colluded, conspired, connived, or agreed with any bidder or anyone else to put in a sham bid, or that anyone shall refrain from bidding; that the bidder has not in any manner, directly or indirectly sought by agreement, communication, or conference with anyone to fix the bid price of the bidder or any other bidder, or to fix any overhead, profit, or cost element of the bid price, or of that of any other bidder, or to secure any advantage against the public body awarding the Contract of anyone interested in the proposed contract; that all statements contained in the bid are true; and, further, that the bidder has not, directly or indirectly, submitted his or her bid price or any breakdown thereof, or the contents thereof, or divulged information or data relative thereto, or paid, and will not pay, any fee to any corporation, partnership, company associations, organization, bid depository, or to any member or agent thereof to effectuate a collusive or sham bid (Public Contract Code Section 7106).

Proposer's Name: Tim D'Zmura
Proposer's Address: 4952 Warner Ave, Ste 227
Huntington Beach, CA 92649

Telephone No.: 714.625.5840

(Signature of Proposer) [Handwritten Signature] (Title) CEO/President

All signatures must be notarized. Attach Notary here.

Attachment: Annealta MV Proposal FINAL (2886 : AUTHORIZATION TO AWARD PROJECT-RELATED SERVICES AGREEMENTS FOR

CALIFORNIA ALL-PURPOSE ACKNOWLEDGMENT

A notary public or other officer completing this certificate verifies only the identity of the individual who signed the document to which this certificate is attached, and not the truthfulness, accuracy, or validity of that document.

State of California)
County of Orange)

Brandon Vargas, Notary Public

On October 10, 2017 before me, _____
Date Here Insert Name and Title of the Officer

personally appeared Paul Timothy Dzmura
Name(s) of Signer(s)

who proved to me on the basis of satisfactory evidence to be the person(s) whose name(s) is/are subscribed to the within instrument and acknowledged to me that he/she/they executed the same in his/her/their authorized capacity(ies), and that by his/her/their signature(s) on the instrument the person(s), or the entity upon behalf of which the person(s) acted, executed the instrument.

I certify under PENALTY OF PERJURY under the laws of the State of California that the foregoing paragraph is true and correct.

WITNESS my hand and official seal.

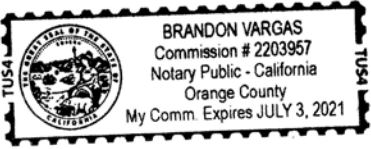

Signature Brandon V
Signature of Notary Public

Place Notary Seal Above

OPTIONAL

Though this section is optional, completing this information can deter alteration of the document or fraudulent reattachment of this form to an unintended document.

Description of Attached Document

Title or Type of Document: Non-Collusion Affidavit
Document Date: October 10, 2017 Number of Pages: 2
Signer(s) Other Than Named Above: _____

Attachment: Annealta MV Proposal FINAL (2886 : AUTHORIZATION TO AWARD PROJECT-RELATED SERVICES AGREEMENTS FOR

AFFIDAVIT OF NON-CONVICTION

I hereby affirm that:

I am the CEO/President and the duly authorized
(Title)

Representative of the firm of: Annealta Group
(Name of Corporation)

Whose address is: 4952 Warner Ave. Ste 227, Huntington Beach, CA 92649

_____ And that

I possess the legal authority to make this affidavit on behalf of myself and the firm for which I am acting.

Except as described in paragraph 3 below, neither I nor the above firm, nor to the best of my knowledge, and of its officers, directors, or partners, or any of its employees directory involved in obtaining Contracts with the City have been convicted of, or have plead *nolo contendere* to a charge of, or having during the course of an official investigation or other proceeding admitted in writing or under oath acts or omissions which constitute bribery, attempted bribery, or conspiracy to bribe under the laws of any State of the Federal government (conduct prior to July 1, 1977 is not required to be reported).

State "none" or, as appropriate, list any convection, plea or admission described in paragraph two above, with the data, court, official, or administrative body; the individuals involved and their position with the firm, and sentence or disposition, if any.

I acknowledge that this affidavit is required to allow the City to make a determination. I acknowledge that, if the representations set forth in the affidavit are not true and correct, the City may terminate ant Contract awarded and may take any other action.

I do solemnly declare and affirm under the penalties of perjury that the contents of this affidavit are true and correct.

Signature:  Date: 10/12/17

Printed Name Tim D'Zmura Title: CEO/President

Name of firm: Annealta Group

Attachment: Annealta MV Proposal FINAL (2886 : AUTHORIZATION TO AWARD PROJECT-RELATED SERVICES AGREEMENTS FOR

VENDOR INFORMATION

A. PROPOSERS COMPANY INFORMATION (print or type)

Company Name: Annealta Group

Owner / Manager Name: Tim D'Zmura

PO Mailing Address: 4952 Warner Ave. Ste 227

City: Huntington Beach State CA Zip 92649

Remit to Address (if different from PO mailing address)

City: _____ State _____ Zip _____

Web Site: www.annealtagroup.com

Phone Number: 714.625.5840

Fax Number: _____

E-mail Address: tdzmura@annealtagroup.com

Incorporated? (mark one) Yes XX or No _____

Fed. Tax I.D. # or Social # 47-5117789

If not a Corporation, are you a Partnership, LLC, Individual or Joint Venture? _____

How many years of relevant experience within the scope of this RFP? _____

I certify that the information given above is accurate and complete; that the Terms and Conditions as issued by the City of Moreno Valley with this Request for Proposal # RFP 2018-006 have been fully read, understood, and accepted in total; and that I am a duly authorized agent for quoting purposes for the company named above.

Tim D'Zmura

CEO/President

(Print Quoting Persons Name)

(Title)

10/12/17

(Quoting Persons Signature)

(Date)

Attachment: Annealta MV Proposal FINAL (2886 : AUTHORIZATION TO AWARD PROJECT-RELATED SERVICES AGREEMENTS FOR

NON-COLLUSION AFFIDAVIT

STATE OF CALIFORNIA)
COUNTY OF) SS

(NAME) Tim D'Zmura, affiant being first duly sworn, deposes and says:

That he or she is sole owner of Annealta Group the party making the foregoing Proposal (Contractor)

that the bid is not made in the interest of, or on behalf of, any undisclosed person, partnership, company, association, organization, or corporation; that the bid is genuine and not collusive or sham; that the bidder has not directly or indirectly induced or solicited any other bidder to put in a false or sham bid, and has not directly or indirectly colluded, conspired, connived, or agreed with any bidder or anyone else to put in a sham bid, or that anyone shall refrain from bidding; that the bidder has not in any manner, directly or indirectly sought by agreement, communication, or conference with anyone to fix the bid price of the bidder or any other bidder, or to fix any overhead, profit, or cost element of the bid price, or of that of any other bidder, or to secure any advantage against the public body awarding the Contract of anyone interested in the proposed contract; that all statements contained in the bid are true; and, further, that the bidder has not, directly or indirectly, submitted his or her bid price or any breakdown thereof, or the contents thereof, or divulged information or data relative thereto, or paid, and will not pay, any fee to any corporation, partnership, company associations, organization, bid depository, or to any member or agent thereof to effectuate a collusive or sham bid (Public Contract Code Section 7106).

Proposer's Name: Tim D'Zmura (print)
Proposer's Address: 4952 Warner Ave, Ste 227 (print)
Huntington Beach, CA 92649

Telephone No.: 714.625.5840

(Signature of Proposer) CEO/President (Title)

All signatures must be notarized. Attach Notary here.

Attachment: Annealta MV Proposal FINAL (2886 : AUTHORIZATION TO AWARD PROJECT-RELATED SERVICES AGREEMENTS FOR

AFFIDAVIT OF NON-CONVICTION

I hereby affirm that:

I am the CEO/President and the duly authorized
(Title)

Representative of the firm of: Annealta Group
(Name of Corporation)

Whose address is: 4952 Warner Ave. Ste 227, Huntington Beach, CA 92649

_____ And that

I possess the legal authority to make this affidavit on behalf of myself and the firm for which I am acting.

Except as described in paragraph 3 below, neither I nor the above firm, nor to the best of my knowledge, and of its officers, directors, or partners, or any of its employees directory involved in obtaining Contracts with the City have been convicted of, or have plead *nolo contendere* to a charge of, or having during the course of an official investigation or other proceeding admitted in writing or under oath acts or omissions which constitute bribery, attempted bribery, or conspiracy to bribe under the laws of any State of the Federal government (conduct prior to July 1, 1977 is not required to be reported).

State "none" or, as appropriate, list any convection, plea or admission described in paragraph two above, with the data, court, official, or administrative body; the individuals involved and their position with the firm, and sentence or disposition, if any.

I acknowledge that this affidavit is required to allow the City to make a determination. I acknowledge that, if the representations set forth in the affidavit are not true and correct, the City may terminate ant Contract awarded and may take any other action.

I do solemnly declare and affirm under the penalties of perjury that the contents of this affidavit are true and correct.

Signature: _____ Date: _____

Printed Name Tim D'Zmura Title: CEO/President

Name of firm: Annealta Group

Attachment: Annealta MV Proposal FINAL (2886 : AUTHORIZATION TO AWARD PROJECT-RELATED SERVICES AGREEMENTS FOR

VENDOR INFORMATION

A. PROPOSERS COMPANY INFORMATION (print or type)

Company Name: Annealta Group

Owner / Manager Name: Tim D'Zmura

PO Mailing Address: 4952 Warner Ave. Ste 227

City: Huntington Beach State CA Zip 92649

Remit to Address (if different from PO mailing address)

City: _____ State _____ Zip _____

Web Site: www.annealtagroup.com

Phone Number: 714.625.5840

Fax Number: _____

E-mail Address: tdzmura@annealtagroup.com

Incorporated? (mark one) Yes XX or No _____

Fed. Tax I.D. # or Social # 47-5117789

If not a Corporation, are you a Partnership, LLC, Individual or Joint Venture? _____

How many years of relevant experience within the scope of this RFP? _____

I certify that the information given above is accurate and complete; that the Terms and Conditions as issued by the City of Moreno Valley with this Request for Proposal # RFP 2018-006 have been fully read, understood, and accepted in total; and that I am a duly authorized agent for quoting purposes for the company named above.

Tim D'Zmura CEO/President

(Print Quoting Persons Name) (Title)

(Quoting Persons Signature) (Date)

Attachment: Annealta MV Proposal FINAL (2886 : AUTHORIZATION TO AWARD PROJECT-RELATED SERVICES AGREEMENTS FOR

REFERENCES

List three (3) references that most closely reflect similar projects and work that your company has worked on within the past five (5) years for a Public or Governmental Agency. (Type or Print)

1. Name of Public Agency: City of Upland
 Address: 460 N. Euclid Avenue
 City: Upland State: CA Zip: 91786
 Contact: Jeff Zwack Title: Development Services Director
 Telephone: (909) 931-4148 Email: jzwack@ci.upland.ca.us
 Service Dates: 2013 - Present
 Brief Summary of Project/Work provided: Planning, Building and Safety
and Engineering Plan Check - see letter of recommendation

2. Name of Public Agency: City of Industry
 Address: 15625 East Stafford Street, Ste 100
 City: Industry State: CA Zip: 91744
 Contact: Alex Gonzalez Title: Director of Development Services
and Administration
 Telephone: (626) 333-2211 x108 Email: alex@cityofindustry.org
 Service Dates: 2017 - Present
 Brief Summary of Project/Work provided: Planning services to assist the City
in the review of new development projects and special program. Staff members are
provided as an extension of city staff. Duties; counter and phone planning assistance
current planning consultations, design review, CEQA/NEPA preparation, etc. See letter

3. Name of Public Agency: City of Cypress
- Address: 5275 Orange Avenue
- City: Cypress State: CA Zip: 90630
- Contact: Doug Dancs Title: Director of Community Development
- Telephone: (714) 229-6740 Email: ddancs@ci.cypress.ca.us
- Service Dates: 2017 - Present
- Brief Summary of Project/Work provided: Tim D'Zmura and various support staff provide a variety of planning and public works services to assist in the review of new development projects and implementation of special projects. We are a member of the City's on-call planning team



E D U C A T I O N

BS, Civil Engineering
University of Notre Dame

MBA, Emphasis in Leadership and
Managing Organizational Change,
Pepperdine University

Certificate in International Business, ESC
Rouen, France

Certificate in International Business,
Oxford University, England

**R E G I S T R A T I O N S
C E R T I F I C A T I O N S**

Professional Civil Engineer
State of California
No. 45607

ICC Certified Building Official
No. 2356

ICC Certified Building Inspector
No. 60961

**P R O F E S S I O N A L
A F F I L I A T I O N S**

International Conference of
Building Officials

American Planning Association (APA)

President-Elect Southern California
Chapter – 2017 APWA

American Public Works Association
(APWA)

Tim D’Zmura, PE, CBO, AICP

Project | Planning Manager

Tim has served in a number of capacities in the fields of civil engineering, municipal public works, current and advanced planning and building safety administration and inspection. He has served public sector clients as in-house public works director, city engineer, planning director, assistant city engineer and building official and has served private sector clients as a director of municipal services, program manager, project manager and design engineer.

His background also includes responsibility for leading and managing the successful delivery of a variety of municipal contract services to numerous cities throughout Southern California. He has dedicated himself to serving the resident’s & client’s needs in the most customer friendly and cost effective manner possible.

Tim has extensive experience in personally providing municipal contract services to communities throughout Southern California. He provides project management, planning services and construction management to the following cities:

| | | | |
|---------|----------------|--------------|----------------|
| Cypress | 2017 – Present | Industry | 2016 – Present |
| Irvine | 2015 - Present | Port Hueneme | 2017 – Present |
| Upland | 2015 - Present | | |

He has personally served as Public Works Director, City Engineer, Deputy City Engineer or Associate Engineer for the following cities:

| | | | |
|--------------|-------------|----------------------|-------------|
| Wildomar | 2009 – 2013 | San Gabriel | 2001 – 2002 |
| Pomona | 2006 – 2009 | Palos Verdes Estates | 1991 – 2000 |
| Los Alamitos | 2002 – 2005 | Hidden Hills | 1990 – 2000 |
| Yucca Valley | 2001 – 2002 | Baldwin Park | 1990 |
| | | Rancho Palos Verdes | 1987 |

Additionally, he has personally served as Building Official for the following cities:

| | | | |
|---------------|-------------|----------------------|-----------|
| Lake Forest | 2014 | Hidden Hills | 1991-2000 |
| Pomona | 2006 - 2009 | Palos Verdes Estates | 1991-2000 |
| Mission Viejo | 1995 | | |



EDUCATION

BS, Urban & Regional Planning
California State Polytechnic University,
Pomona

EXPERTISE

Department Management
Planning Commission Agenda Review
General Plan and Zoning
Entitlement & Project Management
CEQA/NEPA Compliance

PROFESSIONAL AFFILIATIONS

Member of the American Institute of
Certified Planners (AICP)

Member of the American Planning
Association (APA)

Executive Board Member
– Foothill AIDS Project

United Way
– Former Community Liaison

Jerry Guarracino, AICP

Senior Planner

Jerry brings 25 years of progressive experience as a creative planning manager/urban designer with a broad range of current and advance planning experience, managing multidisciplinary teams in the preparation and review of master plans, specific plans, general plan amendments, design guidelines, feasibility analysis, land use analysis, and CEQA compliance.

He brings a wealth of knowledge in processing and project management of specific plans, zoning amendments, conditional use permits, subdivision maps, variances and community relations. His management experience includes economic and community development through CDBG, HOME, and Emergency Shelter Grant Programs.

PROJECT ACCOMPLISHMENTS

- Supervised a 26 person contract planning team assigned to current and advance planning tasks.
- Implemented an ordinance to regulate group homes including sober living homes that was found to be facially valid by the Federal District Court.
- Prepared and presented a companywide webinar on Place-Making through urban design.
- Provided urban design review and/or management for large-scale Specific Plans ranging in size from 1,500 to more than 10,000 dwelling units.
- Prepared Context Sensitive Design Guidelines using a form-based approach.

PROJECT SPECIFIC EXPERIENCE

Senior Planner

City of Upland

Contract (Annealta Group)

Jerry provides a variety of planning services to assist the City in the review of new development projects and special programs. Specifically, he assists the City with the following tasks: Current planning as outlined in Title 17 of the municipal code including design review, site development review applications, sign regulation, variances, CUPs, historic preservation, coordination of CEQA/NEPA preparation, Planning Commission and City Council staff report preparation and attendance at Planning Commission meetings.

OTHER PREVIOUS EXPERIENCE

Interim Assistant Director, Economic and Development Services

City of Costa Mesa

Contract 2 years

Special Projects Manager

City of Eastvale

Contract 2 years, PMC

Community Development Director

City of Calimesa

Contract 2 years, PMC

Planning / Urban Designer

County of Riverside

Contract 7 years, Hogle-Ireland

Tri Planning Group

Chino Hills, CA

5 years

Housing Development Specialist/Sr Associate Planner

County of San Bernardino

8 years

Housing Development Specialist II

LA County

2 years

Assistant Planner

City of Rancho Cucamonga

3 years



REGISTRATIONS CERTIFICATIONS

Certificate in Real Estate and Innovative
Development | Chapman University,
Orange, CA

LEED Accredited Professional –
Neighborhood Development

EDUCATION | TRAINING

Master of Arts in Urban & regional
Planning | UCLA, Los Angeles, CA

Bachelor of Arts in Sociology (Cum
Laude) | Boston University, Boston MA

Undergraduate Studies in Archeology |
University of Rome, Rome Italy

PROFESSIONAL AFFILIATION

American Institute of Certified Planners |
AICP

World Affairs Council in Orange County
| Executive Board Trustee, Programs
Chair (2013 & 2014)

Orange County Armenian Professional
Society | Board Member, Executive
Council President (2014)

Shushi Revival Fund | Executive Board
Members (2006 – 2010)

Seda Yaghoubian, AICP, LEED AP

Senior Planner

Seda is bi-lingual (Farsi, Armenian, French) with 30 years of experience in municipal and regional planning and project management. During her career as an urban and environmental planner, she has taken leadership roles in numerous large-scale private development and public sector planning and infrastructure projects throughout California, and internationally. She has extensive experience in projects dealing with major land development ventures involving complex development agreements and ownership structures, land use/transportation linkages, Federal Base Realignment and Closure (BRAC) process, CEQA and NEPA analysis, zoning, entitlement and growth management policy development. She has managed numerous community outreach efforts for planning, design and construction phases of municipal and private projects. Her attention to detail and focus on critical compliance issues enables her to successfully deliver extremely complex projects.

PROJECT SPECIFIC EXPERIENCE

Senior Planner

2017 – Present

Annealta Group

Assists our clients in the southern California region with a variety of environmental and development planning, entitlement processing, master plan preparation and policy analysis.

Land Development | Entitlement Projects

Various Cities

Prepared and submitted numerous Development Case Applications for 10,000+ dwelling units and 8+ million square feet of commercial/industrial space and requisite technical and environmental studies to more than 30 local jurisdictions. Worked with local staff and made public presentations to obtain project approvals.

Technical Consultant

OCTA

Technical consultant to the prime contractor for the environmental issues of the 5.7-mile, \$273 million project which included freeway carpool lane extensions, ramp modifications, interchange reconstructions, sound walls and other improvements. As a member of the community outreach and government relations team, represented the outreach team in the Project Development Team, and assisted in coordination with Caltrans and several south county cities, community stakeholders, elected/appointed officials and staff.

Senior | Lead Planner

City of Irvine

Lead Principal Planner for the Irvine Business Complex Zone Change, General Plan Amendment and Program EIR – an APA-Award winning rezoning effort for the 2800-acre mixed-use complex adjacent the John Wayne Airport. Prepared a state-of-the-art trip budget land use intensity zoning ordinance to accommodate sixty (60) million square feet of mixed use development, a 20-year, multi-modal circulation improvement program, a nexus-based development fee program, a funding/development phasing plan, and a parcel-specific land use data base for GIS applications. Senior Planner for the Irvine Spectrum zoning and Development Agreement.

Staff Planner

El Toro Reuse Planning Authority

Staff Planner for the El Toro Reuse Planning Authority (ETRPA), a JPA composed of eleven (11) cities working on a non-aviation reuse plan for MCAS-El Toro. Worked with the DoN, the Local Redevelopment Authority (LRA), the FAA and other federal, state and local agencies involved in the closure and reuse of MCAS El Toro. Applied the requirements of base closure legislation and BRAC, base clean-up regulations and other legal, legislative and policy issues related to base closure. Reviewed and analyzed impacts of an airport on the surrounding communities, reviewed and critiqued lead agency environmental documents pursuant to NEPA and CEQA.



E D U C A T I O N

MS, Civil Engineering
California State University Fullerton
Fullerton, CA

R E G I S T R A T I O N S C E R T I F I C A T I O N S

Professional Civil Engineer
State of California
No. C54477
QSP - Qualified SWPPP Practitioner
QSD - Qualified SWPPP Developer

Young James Park, PE, QSP/QSD

Senior Planner

Young brings over 25 years of civil engineering experience and has spent the vast majority of his career serving various jurisdictions in the Southern California region; applying the practices of civil engineering to both private land development and city public works projects.

Young is a registered Civil Engineer in the State of California and a certified Qualified SWPPP Practitioner/Developer. His background has provided him with the knowledge of city engineering policies and procedures, which is a proven asset when providing technical assistance to engineers, architects, contractors, city personnel, and the public.

Young has a strong work ethic, is detailed oriented, and enjoys both project teamwork and working independently. He is extremely skilled in all disciplines of civil engineering required for the successful completion of projects.

P R O J E C T S P E C I F I C E X P E R I E N C E S

Plan Review Engineer

2015 – Present Annealta Group

Provides engineering and plan review services for southern California jurisdictions. Reviews plans and specifications of construction, alteration and repair of commercial, residential, and industrial buildings/structures to ensure plans meet all applicable building, mechanical, plumbing, fire, and electrical code requirements.

Civil Engineer | Plan Review Engineer

2012 – 2014 Interwest Consulting Group

Provided engineering and plan review services, primarily in the City of Bell.

Independent Consulting Engineer

2006 – 2012

Project Manager

City of Pico Rivera

Managed various CIP projects including RAC Grant application, Pico Park parking lot expansion (800K), Rosemead Boulevard and Mines Avenue intersection improvements, incorporated with the L.A County Library project (600K), and Telegraph Road median improvement and street rehabilitation between Rosemead Boulevard and Passons Road (\$1.5 M).

Civil Engineer

City of Lake Forest

Performed engineering plan design review for entitlement. Reviewed private development plans including subdivision map, concept grading plan, preliminary WQMP for BMP effectiveness, and hydrology & hydraulics report. Performed Area Plans reviews with environmental assessment including master roadway systems and master drainage systems with water quality measures. Coordinated with developer and engineer to resolve engineering complex; provided the administrative process for subdivision project.

Consulting Engineer

City of Banning

Engineering design review for private land development consisting of grading plan, storm drain improvement plans, WQMP, and Hydrology Hydraulics analysis.

Consulting Engineer

City of Fullerton

Reviewed engineering plans including street, grading, and storm drain for private land development. Provided administrative support for the issuance of city encroachment permits.

Consulting Coordinator

City of Chino

Coordination of the Edgewater Specific Plan; reviewed EIR and other supporting materials including master watershed hydrology, hydraulics and water quality measures with BMPs, sewer system with capacity analysis, water distribution/transmission system with water



demand analysis, and traffic circulation with public/private roadways network. Prepared engineering design review for various private development project plans, which consisted of public/private roadways, streetlight, sewer line and waterline distribution systems, storm drain, grading, tract and parcel maps, legal descriptions, and LLA (Lot Line Adjustment).

Consulting Engineer City of Fontana

Reviewed Building and Safety plans including drainage and plumbing plans for various private development projects. Provided administrative process for the issuance of various city permits and prepared written comments and conditions for discretionary projects.

Consulting Engineer Riverside County Flood Control District

Design review for various storm drain improvement plans including storm water control with basin systems and water quality facilities. Reviewed WQMP with BMP facilities and drainage improvement design for private development project.

Independent Private Development Project

Provided private development planning and design for street, grading, erosion, sewer conveyance system, water distribution/transmission lines and storm drain improvements, WQMP, SWPPP (Storm Water Pollution Prevention Plan) to obtain a NOI General Construction Permit, topographical land survey, legal description and maps.

Grading Plan & WQMP for commercial buildings in Fullerton, Pomona, and Bell.

Grading Plan & WQMP for condominium residential buildings in Banning.

Grading Plan for single family residential buildings in Corona, Diamond Bar, Villa Park, Altadena and Los Angeles.

Street Plan, Sewer Plan, Water Plan, & Parcel Map 71321 in the City of Cerritos.

Grading, SUSMP, & Street Plans for business building.

SWPPP & SUSMP for City of Bellflower and PM 26419 in the City of Walnut.

Streetlight Improvement Plan & Specifications for the City of Chino.

LLAs and Certificate of Compliance Fullerton and Anaheim Cities.

Senior Engineer

2005 – 2006 Berryman Henagar

Provided civil engineering plan reviews for private development on behalf of various cities - City of Corona, City of Fontana, City of La Quinta, and City of Moreno Valley - including street, sewer conveyance line & waterline distribution/transmission system design, storm drain, rough and fine grading plans, Erosion control plans and other engineering reports to support development. Discussions to resolve complex engineering design issues. Perform the administrative procedure in daily attendance at the Civic Center.

Lead Engineer

2001 – 2005 City of Corona

Reviewed Specific Plan and EIR for large scale development project that consisted of master infrastructures, including sewer system with capacity analysis, water transmission/distribution demand analysis, storm drain improvements with water quality measures, traffic circulation with roadway design, pad grading, assessment of financial impact, and all other necessary provisions. Provided civil engineering plan review including TTM/TPM, subdivision final maps, street improvement plans, sewer line, waterline distribution systems, storm drain improvements, grading, erosion & sediment control plan, hydrology/hydraulics report, WQMP, legal description, lot line adjustment and cost estimate. Present for Development Planning Review and Committee meetings. Coordinated with developers and design engineers to resolve engineering complex. Prepared Council agenda report for the City Council.

| | | |
|---------------------------------|-------------|------------------|
| Senior Civil Engineer | 2000 – 2001 | City of Lawndale |
| Acting Senior Engineer | 1999 – 2000 | City of Corona |
| Associate Civil Engineer | 1993 – 1999 | City of Corona |
| Assistant Engineer | 1988 – 1993 | City of Corona |



EDUCATION

Geographic Information Systems
Certificate & Geography Associates of
Science, In Progress

BS, Business Administration,
University of California, Riverside

AA, Business Administration,
Riverside College

KEY SKILLS

Fluent in Spanish
Municipal planning experience

Dina B. Lomeli

Assistant Planner

Dina is bilingual and fluent in English and Spanish and brings more than ten years of planning/customer service experience in planning and development services. She provides technical planning and support to department staff and the public regarding zoning and General Plan matters and case processing. Her knowledge allows her to effectively and professionally respond to a wide range of inquiries.

PROJECT SPECIFIC EXPERIENCE

Assistant Planner

2017 – present Annealta Group

Performs a variety of planning services supporting inhouse staff including counter and phone planning assistance, current planning consultations, design review, processing of site development review applications, variances, staff reports and other duties as assigned.

Planning Aide

2015 – present City of Alhambra

Performs technical planning and provides support to the professional planning staff and the public regarding zoning and General Plan matters and case processing

- Updated the Landscape Ordinance.
- Processed entitlements and wrote staff reports to present to the Planning Commission for Conditional Use Permits and Land Development Permits.
- Interacted with the public regarding complex environmental, zoning, and development codes and assisted them in conforming to City regulations.
- Lead role for the Planning Division in implementing the "Public Stuff" web application.
- Lead role in the research and testing for the new permit tracking system that will be implemented.
- Currently updating the application for the new wireless requirements.
- Team member for the General Plan Update.

Development Services Representative/Assistant Planner/Planning Technician

2002 – 2015 City of Fontana

Development Services Representative

Provided customer service as initial contact with the public responding to a high volume of inquiries in a responsive, accurate, and timely manner in English and Spanish requiring an understanding of the policies and procedures of the Department.

- Provided research dealing with a wide range of customer issues and problems
- Followed status of plan check submittals and notified applicant of the progress of their project.
- Provided status information for the public utilizing tracking software
- Provided research inquiries for historical documents to residents or developers.
- Coordinated inspections for applicants

Assistant Planner

Function as Project Manager independently on five to ten simultaneous projects for presentation to the City's Design Advisory Board and Planning Commission for approval, in addition to all responsibilities as Planning Technician.

- Interact with the public regarding complex environmental, zoning, and development codes and assist them in conforming with City regulations



- Coordinate with all departments for comments and input; ensure all project presentations are completed and in conformance with zoning and development codes for submission to the appropriate Board for approval
- Conduct project presentations to the various Boards and function as liaison with the public to translate and interpret Boards' reply; upon approval schedule and coordinate public hearings
- Evaluate environmental projects for conformance with the Environmental Quality Act; prepare staff reports to meet critical deadlines for presentation at public hearings before the Planning Commission
- Research parking requirements for residential request for additions and regulations for industrial/commercial requests for additions; coordinate activities with Engineers and the applicant to resolve problems and move forward on the project
- Participate as member of Specific Plan Committee to update old Specific Plan Regulations

Planning Technician

Perform technical planning and provide support to the professional planning staff and the public regarding zoning and General Plan matters and case processing working independently in this high volume, fast paced environment.

- Ensure customer service requirements are managed efficiently including resolving conflicts requiring sensitivity and independent judgment
- Research and draft ordinances for review
- Interpret and apply federal, state, and local policies, procedures, laws and regulations
- Maintain internal control policies and procedures to ensure compliance with regulations
- Coordinate with 13 City Departments; research and develop Zoning and Development Codes to interpret and respond to inquiries from the public and other departments
- Review basic zoning, variances, conditional use permits, design review and other related applications
- Prepare legal notices to public hearings and reports pertaining to the advisability and permissibility of the requests; confer with property owners and applicants regarding the effect and implications of zoning and development actions
- Review building plans and related applications for conformance with regulations and conditions of approval of various requests
- Monitor progress and status of assigned projects to ensure quality and on time completion
- Interpret and explain policy changes and their effect on special projects
- Prepare graphics and technical drawings for presentation to the City Council, Planning Commission, and various Boards; respond to Board Member questions
- Read and interpret building, site, building elevation, and grading plans



EDUCATION

MS, Geographic Information Science,
California State University, Long Beach
BA, Geography,
California State University, Long Beach
Certificate in GIS
Certificate in Urban Studies

KEY SKILLS

Fluent in Spanish
Functioning knowledge of ArcGIS Pro
Working knowledge of CEQA

Nathalie Ann Vazquez

Assistant Planner

Nathalie is bilingual in English and Spanish and has an excellent understanding of the municipal planning process having served as an intern for the City of Santa Ana. Her experience includes a variety of planning activities including the processing of CUPs and technical data management for municipal GIS systems. She possesses excellent communication, presentation and customer service skills.

PROJECT SPECIFIC EXPERIENCE

Assistant Planner

2017 – present Annealta Group

Performs a variety of planning services supporting inhouse staff including counter and phone planning assistance, current planning consultations, design review, processing of site development review applications, variances, staff reports and other duties as assigned. She also assists in preparing technical data, zoning maps, and other GIS information for municipal GIS systems.

GIS Field Technician

2016 – present D&W Consulting

Provides contract GIS services for The Irvine Company which include:

- Visiting Irvine Company's retail sites and collecting data independently.
- Standardizing data collected on-site into geodatabase.
- Regularly updating Irvine Company's tenant database using GIS.
- Reading site plans and georeferencing images using ArcMap.
- Digitizing and editing mechanical data collected on-site using ArcMap.
- File and data management, accurate data entry.
- Developed modern data collection methods currently used by all data collectors.
- Using python and Model Builder on ArcMap

Management Intern, Planning

2014 – 2016 City of Santa Ana Planning and Building

- Processed CUP applications for on-site consumption of alcohol for eating establishments
- Assisted the GIS administrator with updating the City's zoning and general plan map.
- Prepared materials for meetings and presentations for Planning Commission & City Council.
- Constructed GIS maps related to The City's potential development areas using ArcMap.
- Computed written reports related to zoning and land use, zoning verification letters.
- Supported the planning staff with projects that require development project review.
- Aided planning counter staff with various over the counter applications.
- Attended and presented items at public hearings and meetings as needed.
- Answered the public's questions or concerns related to planning or zoning.
- Interpreted the municipal code to the general public.

Volunteer Intern

2015 – Present Long Beach Transit Service & Planning Department

- Managed and organized large databases that contain ridership data.
- Transferred ridership data from Microsoft Access to ArcMap.
- Completed requests for GIS maps from various departments.
- Assisted with developing internal and external reports.
- Used statistical methods to show ridership analysis.
- Attended Stop Committee meetings and discuss proposed locations for bus stops.
- Contributed with Title VI report that shows no discrimination with transit service.
- Collected ridership data through surveys from customers using Long Beach Transit service.



Monica Ornela

Planning Technician

Monica is a bi-lingual permit technician with 8 years of comprehensive experience in the building arena. She is customer-oriented, independent and proactive in delivering skilled, professional services to building contractors, architects, engineers and the public. She has experience and is proficient with many permit and land development software programs including Speed Web, EnerGov, Tyler Technologies/Munis and HdL/PrimeCloud.

Monica is responsive to both external and internal clients with a friendly, professional approach. She specializes in being able to quickly and successfully adjust to changes in tasks and processes and is very organized in her responsibilities. Her interaction with co-workers at all levels in a jurisdiction is done in a collaborative and professional manner. Monica especially takes to heart performing all her duties within the context of the client's requirements, mission and values. She applies great energy and pride to her work and is an asset to our clients.

PROJECT SPECIFIC EXPERIENCE

Planning Technician

2017 – Present Annealta Group

Performs front counter support and permit technician services to clients throughout Southern California. She processes residential and commercial documents and applications received related to permit issuance. She assists the development community by being available to answer questions and inquiries in a timely, accurate and friendly manner.

Permit Technician

2015 – 2017 City of Covina (Contract)

2011 – 2015 City of Pomona (Contract)

Processed and issued building, electrical, mechanical, plumbing, grading, paving, fire, and other permits. Explained permit and plan check processes, ordinances, requirements, City codes, and department procedures to building contractors, architects, engineers, and the public. Read and interpreted plans, specifications, related construction documents, and maps. Reviewed and approved solar panel, pool and temporary stage plans over the counter. Directed the public to various City departments for information necessary to apply for permits. Verified workman's comp, valid contractors' license, and valid business license information had been filed with the City. Assisted the public with complete building history of properties. Accepted construction plans and documents for permit and plan check processing. Reviewed and accepted permit applications to ensure completeness and accuracy. Calculated fees for permits and plan checks. Tracked and answered questions related to status of permit applications and plan check process. Dispersed plans to proper department(s), depending on the project. Explained inspection requirements to applications. Assisted building inspectors with records research and compiling data and logged their weekly schedules. Notified applicant when plans have been approved and ready for permit issuance.

Office Assistant

2010 – 2011 City of Pomona – Housing Department

Initial contact for residents obtaining information the Housing Departments various loans, grant programs and federally assisted programs, primarily Section 8 and TBRA. Provided customer service at the front counter and over the phone. Filed, organized and maintained adequate amount of confidential client and interested party forms. Conducted one-on-one interviews with low income families to determine eligibility. Processed and prepared documents, such as contracts and payment demands. Assisted City staff with



Tamara Marquez

Planning Technician

Tamara is a highly organized and professional permit technician with more than 12 years' experience serving a variety of municipal clients. Her skills include front counter and back office duties including: assisting walk-in customers with general inquiries about permit applications, processing payments, and issuing appropriate permits; conducting minor plan check to ensure compliance with building code requirements; routing plans; maintaining the permit tracking system; collecting and recording of fees; creating monthly reports and logs; and routing and tracking plans. She manages the front counter in a friendly and professional manner.

PROJECT SPECIFIC EXPERIENCE

Permit Technician (Contract)

2014 – Present City of Upland | Annealta Group

Her primary responsibilities include customer assistance related to issuances of permits; reviews, plan check and processing of residential and commercial construction documents and applications received; routing plans, providing estimates for both permit and plan check fees, new development review requirements, simple room additions, assistance in permit reviews, refunds, bonds, grading and paving. Effectively answers inquiries and handles complaints in a professional and timely manner. Maintains accurate records, databases, and communication from application through final permit issuance. Processes and provides monthly building reports to public and governmental agencies.

Permit Technician (Contract)

2013 City of Irvine

- Processed and calculated plan check and permit fees for minor and major projects in the Inform Gold Eden program
- Provided excellent customer service to developers, contractors, and home owners at a public counter, and work as a team with colleagues to keep the work environment organized and efficient
- Interacted with Community Development department staff and examine computer records to monitor and coordinate the movement of plans throughout the permit process

Permit Technician (Contract)

2013 City of Hawaiian Gardens

Received and reviewed building applications from customers; assessed scope of project and relevant permit requirements; educated customers regarding necessary permits and general code compliance of proposed projects. Verified that projects have obtained all necessary approvals; verified professional and contractor licensing. Calculated and verified valuations and fees; accepted payments and issued permits as authorized. Maintained records and prepared reports as required. Assisted in completing permit applications by explaining building permit requirements; assisted and advised the general public in matters relating to building requirements and status of submitted projects. Tracked plan check applications from submission until approval; routed plan checks to appropriate personnel.

Permit Technician (Contract)

2009-2013 City of El Monte

Plans Coordinator and Clerical Assistant (Contract)

2008-2009 City of Menifee



CERTIFICATIONS

ICC Certified Permit Technician
Combination Dwelling Inspector
Building Inspector
ATC-20 Post Disaster Safety Assessment

EDUCATION

Los Angeles Harbor Collegem | 2010 – Present | Architecture & Building

Webster Career College | 1990-1991

Numerous ICC / IAPMO Training Seminars
- ATC Post Disaster Safety Assessment
- Overview of the 1997 UBC
- On the Front Line: Permit Counter - 2000 UMC
- Simplified Engineering I & II
- ITC Plan Check
- Combo Field Inspection
- Commercial Residential Electrical Inspection
- Water Quality Training
- Combo Dwelling Inspection
- Building Inspector
- Plan Check I & II
- Detailed Means of Egress
- Combo Inspection I & II
- Title 24 2001 Energy Overview & 2005 Standards Preview
- 2002 National Electrical Code
- 2005 Title 24 Energy Updates
- Nonresidential Disabled Access
- Multi-residential Disabled Access
- Post Disaster Safety Assessment 2005

MEMBERSHIPS

International Code Council

Laura Griffin

Planning Technician

Laura is an ICC Certified Permit Technician bringing over 16 years of direct experience serving municipalities in southern California. She is also a certified building and combination dwelling inspector making her a multi-faceted and flexible resource to our clients. She possesses the ability to work with a variety of software programs and read detailed construction documents.

Laura's extensive training in a wide range of areas combined with her calm leadership, organization style and effective communication skills is what makes the difference to our clients and those she works with.

PROJECT SPECIFIC EXPERIENCE

Permit | Planning Technician

2015 - Present Annealta Group

Serves clients by providing outstanding support to the City and their community

Permit Technician

2014 - 2015 Interwest Consulting Group

Serves a variety of clients as a Permit Technician in the Southern California Region.

Permit Technician

2002 - 2006 Charles Abbott Associates

Laura served as a Permit Technician for the cities of Palos Verdes Estates, Camarillo and Rancho Palos Verdes. Was responsible for all aspects of managing the permit counter including; providing customer assistance to contractors, home owners and developers for permit issuance for both residential and commercial projects. Assisted with plan reviews, provided estimates for both permit and plan check fees and routing and tracking of all plans. Answered a variety of questions and handled all complaints in a courteous and professional manner.

Developed a records management process to ensure the most efficient tracking and administration of building permits, processed monthly reports and maintained excellent communication between city departments.

Permit Technician

1991 – 2002 City of Palos Verdes Estates

Provided a high level of customer service at the permit counter for the Building Department. Responsibilities included plan check submittals for commercial and residential projects, issuing of permits, explain verbally and in writing technical information to the public, specifically city codes, policies, procedures and regulations. Calculate plan review, inspection and other related fees. Prepared various reports for management.

CUSTOMER CARE STANDARDS

Annealta Group's Strengths

Today's development environment can place increased demands on city staffing resources. Annealta Group can help alleviate or minimize this staffing resource burden and at the same time provide a high level of customer service in a budget friendly manner and we possess the ability to adjust service levels as needed. We fully understand these resource demands, have experience in successfully providing services under these conditions and are committed to working for you and the residents of the City.

We propose to provide the City the following fundamental elements:

- ✓ **Customer service.** One of the keys to the success of your department is providing your customers (residents, architects, engineers, contractors) with excellent service. We are committed to providing a level of service to you and your constituents that will meet or exceed your expectations.
- ✓ **Tailored, City-specific services.** We deliver skilled and thorough planning services. Experienced staff will be assigned to projects that possess both the technical know-how and communication skills necessary to effectively process projects according to City policies and procedures.
- ✓ **Effective Coordination with other City Departments.** We are proud of our staff's track record of effectively communicating and coordinating with other City divisions and departments. We understand the one stop shop approach to providing a high level of service to residents and developers alike.
- ✓ **Project Controls.** The services we provide are always closely coordinated and monitored to ensure we meet or exceed the service levels desired by the City, but also stay within the financial capacity of your operating budget. We have broad experience and "hands on" knowledge of municipal budgeting, specifically related to expenditures and cost recovery associated with private development processing and permitting. We will work in close partnership with the City, tailoring our services and deployment of staff to match the allocated budget.



All work will be performed in accordance with the Customer Service Standards set forth in the Momentum MoVal 2016 Strategic Plan Report. Specifically, we will adhere to the following standards:

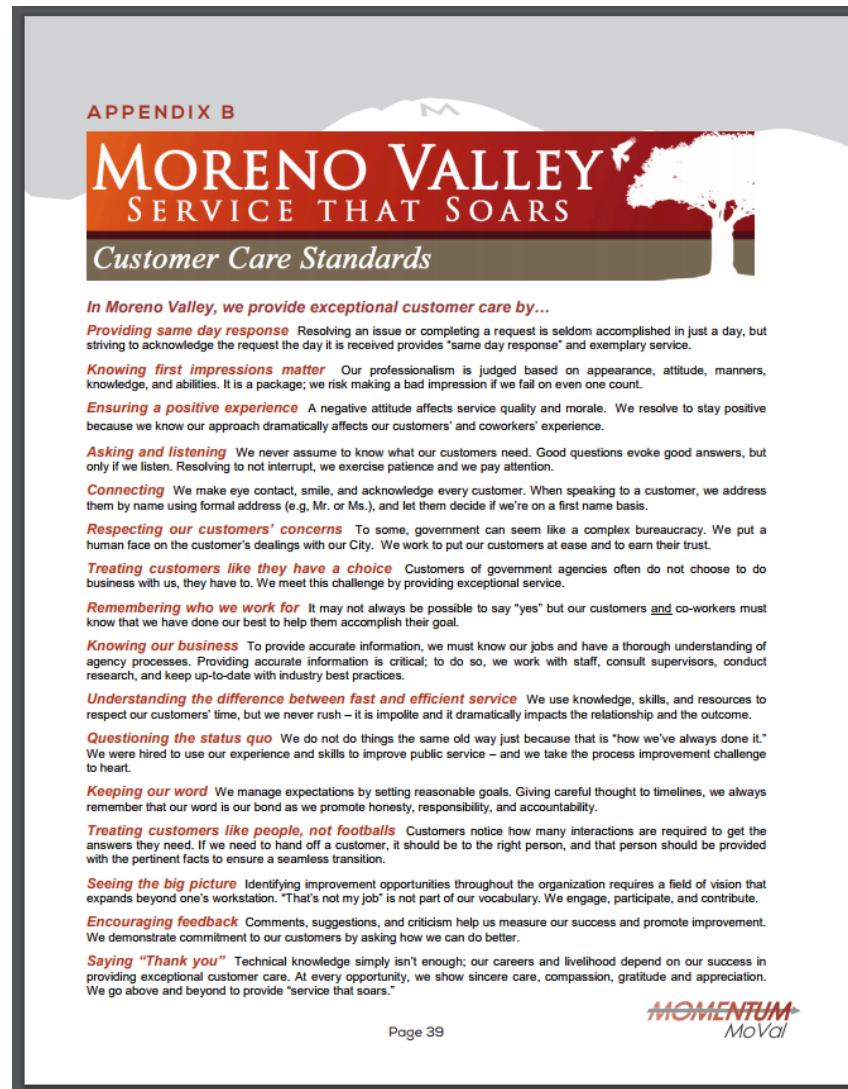

Our assigned staff will familiarize themselves with all City documents and plans that provide the framework, policies and guidelines for development. We will pay special attention to the Specific Plans as follows:

Auto Mall

- ✓ SP-209 Amendment No. 3
- ✓ SP-209 Amendment No. 4
- ✓ SP-209 Amendment No. 5

Industrial Area

- ✓ SP-208 Industrial Area

World Logistics Center

- ✓ SP-WLC

The Village

- ✓ SP-204 The Village



FEE SCHEDULES

Annealta proposes the following fee schedule for services provided.

A) DEPOSIT BASED PROJECTS & EXTRA MEETINGS - HOURLY RATES FOR SERVICES

| Classification | Rate |
|----------------------------------|-------|
| Project/Planning Manager | \$125 |
| Senior Planner | 115 |
| Associate Planner II..... | 105 |
| Associate Planner I..... | 100 |
| Assistant Planner III..... | 95 |
| Assistant Planner II..... | 90 |
| Assistant Planner I..... | 80 |
| Planning Technician II | 75 |
| Planning Technician I | 70 |
| Administrative Support III | 60 |
| Administrative Support II | 45 |
| Administrative Support I | 30 |

*Expedited services are available at 150% of the above stated rates.
 *Personnel hourly rates include all costs for overhead, including phones, cellular, vehicles, mileage and other direct and indirect costs.
 *All rates are effective until December 31, 2018

B) FLAT FEE PROJECTS – PERCENTAGE OF THE CITY’S FEE SCHEDULE

For project types and services that are offered to applicant pursuant to Section 3 –Community Development “Planning” of the City’s adopted fee schedule, we propose the following fee structure:

- ✓ 65% of the City’s fee schedule
- ✓ 90% of the City’s fee schedule for expedited services

Attachment: Annealta MV Proposal FINAL (2886 : AUTHORIZATION TO AWARD PROJECT-RELATED SERVICES AGREEMENTS FOR



Attachment "3"

October 12, 2017



PROPOSAL TO PROVIDE
 AS-NEEDED PLAN CHECK AND
 ENTITLEMENT SERVICES
 RFP No. 2018-006

Submitted to:
 The City of Moreno Valley



27362 Calle Arroyo | San Juan Capistrano, CA 92675
 949.489.1442 | www.civicsolutions.com

Attachment: Civic Solutions MorenoValley Proposal FINAL (2886 : AUTHORIZATION TO AWARD PROJECT-RELATED SERVICES

October 12, 2017

Allen Brock
Community Development Director
Richard Sanzimier
Planning Official
City of Moreno Valley
14177 Frederick Street
P.O. Box 88005
Moreno Valley, CA 92552

**Re: Proposal to Provide As-Needed Plan Check and Entitlement Services
(RFP No. 2018-006)**

Dear Mr. Brock and Mr. Sanzimier:

Civic Solutions, Inc. is pleased to submit this proposal for As-Needed Plan Check and Entitlement Services for the City of Moreno Valley. We acknowledge receipt of Request for Proposal No. 2018-006 as well as RFP Addendums 1 and 2. Our proposed services include the performance of a variety of complex professional level duties in support of the City's current planning functions.

Civic Solutions has successfully provided staffing services to Southern California cities and counties since 1991. We specialize in providing a full range of planning services including: plan checks, public counter assistance, ministerial and discretionary case processing, project management, inspections and environmental review. We are accustomed to tailoring our services to the needs of municipalities in terms of hours, schedules, duration, and work location. Our professional staff members are experts in their fields and perform efficiently and effectively for the cities they serve.

As outlined in our proposal, Civic Solutions has extensive experience providing similar services throughout Southern California. Our staff has managed all types of plan checks and ministerial and discretionary entitlement projects including residential, commercial, industrial, mixed-use, and transit-oriented development. We also have extensive experience conducting CEQA reviews, managing special projects and working on advanced planning efforts. As on-call staff, we would provide the most highly qualified person for each project according to the skills and expertise required by the City of Moreno Valley.

As you review our submittal, please consider the following key points demonstrating the benefits that the Civic Solutions team brings to the City:

27362 Calle Arroyo
San Juan Capistrano, CA 926

949/489-1442

949/240-8068 FAX

www.c

Packet Pg. 100



The Right Experience. Civic Solutions has maintained its commitment to serving public agencies for over 26 years. During this time, we have successfully delivered comprehensive planning services to public agencies in Los Angeles, Orange, San Diego, Ventura, San Bernardino and Riverside Counties. We have demonstrated project management abilities and planning expertise through a wide range of recent and relevant projects with our public agency clients. We consistently develop a thorough understanding of our municipal client’s policies and procedures and satisfy performance expectations.

Team Resources. Civic Solutions only employs professional staff with extensive public agency experience and who consider working in the public interest to be their passion. We provide staff that is professionally competent and knowledgeable of the public agency’s unique development requirements, provides outstanding customer service and public relations, and meets City performance standards without close supervision.

Availability and Commitment of Staff. We have the depth of resources needed for long-term contract services. Civic Solutions can ensure the City that staff resources are available to meet the requirements of the services and any modifications in the workload.

A Proven Process. We have developed a highly refined process of managing staffing functions that ensures user-friendly service that is responsive, timely, of high quality and efficient. Our ability to effectively manage case processing minimizes the cost to applicants and the City.

No Conflict of Interest. Over the life of our firm, we have focused almost exclusively on providing services to public agencies. Our private sector work, which amounts to less than 5% of our business, is for homeowner associations, individual business or landowners and non-profit organizations. Because we have no clients or business interests in the real estate or development industry, our services are always free of conflict of interest issues.

Thank you for the opportunity to submit this proposal. We are confident that you will find that our firm’s capabilities, technical expertise, and key personnel – along with our management’s commitment – match the City’s selection criteria. We look forward to discussing how Civic Solutions can assist the City of Moreno Valley by providing high quality as-needed planning services.

Sincerely,

Thomas G. Merrell, AICP, President
merrell@civicsolutions.com
949.489.1442

Mary P. Wright, AICP, Vice President
wright@civicsolutions.com
949.489.1442

27362 Calle Arroyo
San Juan Capistrano, CA 926
949/489-1442
949/240-8068 FAX

www.c

Contents

Cover Letter--

A. Introduction..... 1

B. Qualifications..... 3

C. Scope of Work..... 5

D. Personnel..... 7

E. References..... 10

F. Authorization 12

G. Fee Schedules..... 13

H. Time Schedules 14

I. Transportation of Plans 15

Required Forms..... 16

Appendices 23

Attachment: Civic Solutions Moreno Valley Proposal FINAL (2886 : AUTHORIZATION TO AWARD PROJECT-RELATED SERVICES

A. Introduction

Civic Solutions is a planning and community development consulting firm that provides comprehensive planning and entitlement services to municipalities, special districts and other public agencies. The firm is established around the principle that community planning and development ultimately serve the public interest.

Civic Solutions was established in 1991 and has maintained its focused commitment to serve public agencies for the last 26 years. The company is a California Corporation, led by its owner and founder Thomas G. Merrell, AICP, President and Chairman of the Board. Tom is responsible for the firm's contractual actions. Guided by the company philosophy that

Our team has extensive experience performing plan checks and ministerial and discretionary project reviews. We fit seamlessly into the cities we serve and quickly get up-to-speed on an agency's policies, regulations and processes. Our work is effective, efficient and of the highest quality.

planning is for people, Civic Solutions is ideally equipped to successfully provide planning services to the satisfaction of our clients and the communities we serve.

I. Methodology/Approach

Civic Solutions prides itself on assembling capable and qualified multi-disciplinary teams who have the skills and experience to perform the unique services needed by the agency. We fit seamlessly into the cities we serve and maintain open lines of communication. We are experienced professionals whose primary function is to provide expert planning capabilities for our municipal clients.

Our approach to municipal planning services centers around three primary tenets: assign experienced and capable staff, understand the needs of the City, and perform quality work within the scope and timeline dictated by the City, State as well as sound planning practices.

Civic Solutions methodology for the City of Moreno Valley planning services is outlined in detail in Section C – Scope of Work. Services will include:

Plan Checks

- ✓ Conduct planning plan checks of grading, site development plans, landscape plans and building permits
- ✓ Review for conformance with City policies, regulations, entitlements and mitigation measures
- ✓ First reviews within 8 days; subsequent reviews within 5 days

- ✓ Expedited 1st reviews within 4 days; subsequent reviews within 3 days

Entitlement Reviews

- ✓ Conduct planning review of entitlement applications
- ✓ Review for compliance with the General Plan, Municipal Code, State and Federal laws and other policies and regulations
- ✓ First reviews within 12 days; subsequent reviews within 8 days
- ✓ Expedited first reviews within 4 days; subsequent reviews within 3 days

Environmental Review/CEQA

- ✓ Conduct preliminary environmental scoping to determine appropriate level of review
- ✓ Prepare Notices of Exemption, Initial Studies, Notices of Availability, etc.
- ✓ Review technical studies and third-party environmental documents for conformance with City policies and state law
- ✓ Coordinate environmental review with City, state and outside agencies

Inspections

- ✓ Conduct inspections of residential, commercial and industrial projects prior to Building Final and/or Certificate of Occupancy
- ✓ Review for compliance with approved plans, documents, conditions of approval and mitigation measures
- ✓ Document inspection results

2. Firm Contact Information

Civic Solutions, Inc. is headquartered in San Juan Capistrano with a satellite office in the City of Ontario. Plan check and entitlement services for the City of Moreno Valley will be performed out of both of these offices and out of City Hall. Tom Merrell will serve as the Management Contact for the City and the firm’s Vice President, Mary Wright will serve as the Project Coordinator/Project Manager. Mary will be the City’s primary liaison and will coordinate all contractual negotiations and staffing needs and will provide project oversight. The firm’s contact information is as follows:

Civic Solutions – Headquarters
 27362 Calle Arroyo
 San Juan Capistrano, CA 92675
 Phone: 949/489.1442
 Fax: 949/240-8068
wright@civicsolutions.com
www.civicsolutions.com

Civic Solutions – Satellite Office
 3200 Guasti Road, Suite 100
 Ontario, CA 91761
 Phone: 909/930.3999
 Fax: 949/240-8068
wright@civicsolutions.com
www.civicsolutions.com

3 & 4 Personnel/Areas of Responsibility

Civic Solutions prides itself on hiring qualified professionals who are committed to providing the highest level of municipal planning services. We have identified the following professionals to provide planning services to the City of Moreno Valley. For a more detailed description of our team’s background, please refer to Section D – Personnel, as well as our complete resumes that may be found in the Appendix 2. All of our team members are Civic Solutions employees with the exception of Albert G. Armijo who works closely with us on a subconsultant basis.

Thomas G. Merrell, AICP –
 Management Contact

Mary P. Wright, AICP/LEED AP ND –
 Project Coordinator/Project Manager

- Kirt A. Coury – Senior Planner/Entitlements
- Albert G. Armijo – Senior Planner/
Entitlements/Plan Checks
- Chris D. Moore, AICP/ENV SP – Senior
Planner/ Entitlements
- Richard S. Fisher – Associate Planner/Plan
Checks
- Sigfrido G. Rivera – Associate Planner/
Entitlements/Plan Checks
- Tiffany Chhan – Assistant Planner/
Entitlements/Plan Checks
- Alphonse Norpetlian – Assistant Planner/
Plan Checks
- Whitney Wagner – Planning Technician/
Entitlements/Plan Checks

Attachment: Civic Solutions MorenoValley Proposal FINAL (2886 : AUTHORIZATION TO AWARD PROJECT-RELATED SERVICES

B. Qualifications

Core Services

We deliver “added value” service in all planning functions. The experienced professionals who staff our firm have extensive backgrounds in public-sector service. Some of the firm’s recent clients include the cities of Montclair, Pomona, San Clemente, Lake Forest, Oceanside, Encinitas, Compton, Fountain Valley, Irvine, Jurupa Valley, Yorba Linda, and Huntington Beach.

Our services include all functions of a municipal planning department, including ministerial and discretionary case processing, public information services, environmental analysis, plan checking, site visits, inspections, mitigation monitoring, zoning code amendments, architectural design guidelines, specific plans, policy planning and general plan updates. We provide support services in the form of graphics, design evaluation, analysis of alternatives, report writing, environmental impact documentation, annexations, grant writing, housing elements, citizen participation programs and other community development activities.

Planning Services

Civic Solutions has earned an excellent reputation throughout Southern California for our contract planning and environmental review services. We are able to quickly get up to speed on a jurisdiction’s regulations, policies and operating procedures and seamlessly provide current and advanced planning services. Our staff regularly provides counter services, customer support, discretionary case processing, plan checking, report writing and presentations to Planning Commissions and City Councils.

We are skilled at development review and are able to perform slope and grading analyses, assess view impacts and evaluate project design features. We fit seamlessly into the organizations we serve. It is our goal that applicants cannot distinguish between staff and consultant project managers. We are also experienced long range planners and can readily interpret policies, evaluate issues, and

prepare general plan amendments, code amendments, focused issue studies, etc.

Entitlement Processing

Uniquely organized and staffed for this purpose, Civic Solutions provides development review and ministerial and discretionary case processing services efficiently and effectively. Our philosophy is to perform the work to the standards of our municipal clients. Seeking feedback from staff, Planning Commissioners and applicants, we continuously fine-tune our work methods. We fit seamlessly into the organizations we serve.

Permit Plan Review

Building and grading permit clearances are much shorter in duration and primarily require review for code compliance, conditions of approval and consistency with approved plans. Our planners are prepared to expedite the plan review process for all permit review cases, including those for which the entitlement case was handled by City staff.

Environmental Services

Civic Solutions’ technical staff provides environmental planning and review for our municipal clients. Our expertise includes environmental analysis, CEQA/NEPA documentation, resource agency permitting assistance, and mitigation and monitoring programs. We perform the full range of environmental documentation from Initial Studies and Exemptions through review and/or preparation of Environmental Impact Reports (EIRs) and Environmental Impact Statements (EISs). Public agencies value our ability to prepare thorough and legally-defensible environmental documents in compliance with state and federal requirements.

Inspections

Civic Solutions conducts planning inspections of residential, commercial and industrial projects under construction. Our inspections focus on whether the project is adhering to conditions of approval, mitigation measures and other requirements worked out in the project approval process. By inspecting projects before completion, our staff ensures that important planning features are incorporated into the finished product.

Project Management Services

Civic Solutions has been particularly successful in managing specific projects for our public agency clients. High profile projects of critical importance to the city or county for tax base and economic development must have a sustained focused effort in order to keep the applicant's process on track. Our senior project managers have provided such services for resort hotel projects, large scale mixed-use development, renewable energy plants, and annexations.

Land Use and Policy Planning

Civic Solutions professional staff has the broad base of urban planning experience needed to prepare land use plans and to evaluate their impact on the environment, municipal services, traffic, schools, and open space.

- Master Plans
- Land Use Elements
- General Plan Elements and Updates
- Specific Plans
- Zoning Code Updates and Amendments
- Economic Development Programs
- Hillside Development Standards
- Historic Preservation Standards
- Open Space Preservation
- Annexations
- Housing Programs

Process Evaluation Programs

Civic Solutions assists public agencies improve and manage their organizational effectiveness and improve their development review processes. We provide recommendations for improving efficiencies and reducing costs, prepare detailed procedure manuals and train staff. Our City clients have been pleased with the improvements they have seen after implementing Civic Solutions' recommendations.

Training and Citizen Participation Programs

Civic Solutions is available to conduct trainings to staff, elected and appointed officials and community members on planning processes, their role in the process and on technical matters, such as how to read grading plans. In addition, we are skilled at developing effective Citizen Participation Programs to inform the public about planning projects and programs and diffuse controversy in advance of the public hearing process.

Revitalization and Design Services

Civic Solutions provides downtown revitalization services and architectural design guidelines and specific plans through its Downtown Solutions Division. This division has been engaged in projects throughout California providing design-focused services for our municipal clients.

C. Scope of Work

Civic Solutions staff will perform plan check and entitlement services as requested by the City of Moreno Valley. Our staff is fully qualified to provide all of the services outlined in the RFP No. 2018-006. Staffing will be coordinated and supervised by Mary P. Wright, Civic Solutions Vice President and Director of Planning Services. Mary and our entire team look forward to working with Moreno Valley to identify the most qualified staff member to perform each project assigned by the City.

The paragraphs below outline our approach to plan checks, land use entitlements, CEQA review and inspections. We also discuss our commitment to the City's Customer Care Standards and our capability to perform electronic plan reviews.

Plan Checks

Civic Solutions will conduct plan checks of small and large residential, commercial and industrial projects. We will review grading, site development, landscaping and building permits to ensure consistency City's Municipal Code development regulations as well as conditions of approval to related land use entitlement permits and CEQA mitigation measures. We will attend required meetings associated with our plan reviews and submit two complete, typed listings of plan check corrections in the appropriate format. Corrections will also be recorded in the City's "Simplicity" tracking system as necessary. Initial plan checks will be provided within eight days from the date the City receives the plans for review; subsequent reviews will be provided within 5 days. For expedited plan checks, Civic Solutions will provide first review corrections within four days and subsequent reviews within three days.

Land Use Entitlements

Civic Solutions is fully equipped to manage major and minor development applications for the City. We have the ability to manage multiple project deadlines; determine application completion; review projects for conformance with policies and regulations;

prepare written reports, conditions, resolutions and notices; and make presentations at public hearings. We develop and maintain good working relationships with City staff, developers and community members and operate in a collaborative and cooperative manner. We also regularly monitor project schedules and budgets and keep the City informed of all of our work efforts.

Upon receipt of land use entitlement applications, generally on the day following submittal, our staff will immediately conduct a thorough review of the project. We will review the project for conformance with the Moreno Valley General Plan and Municipal Code, particularly Title 9 – Planning and Zoning and Title 7 – Cultural Resources, as well as good planning practices any other applicable policies and regulations. We will work with City staff and management on any issues or clarifications and provide project comments and enter them within the "Simplicity" system within twelve days from the date the City receives the plans for review. Subsequent reviews will be conducted within a maximum of eight days. Expedited entitlement reviews will be provided within four days for initial submittals and three days for subsequent reviews. Our reviews will include conducting an environmental assessment per the California Environmental Quality Act (CEQA), as outlined in the following section.

Upon deeming a project complete, Civic Solutions will work to prepare projects for an administrative approval or a public hearing. We will prepare notices, conditions of approval, resolutions, staff reports, etc. as well as presentation materials, such as PowerPoint presentations. Our time includes participation in staff meetings such as the Project Review Staff Committee (PRSC), meetings with City Development Services staff, meetings with the applicant, other coordination/agency meetings as well as Director, Planning Commission and/or City Council hearings. For the purpose of this proposal, we have assumed a total of five meetings per project; additional meetings and/or hearings can be provided at the hourly rates contained in Section G, Fee Schedules.

Environmental Review/CEQA

Our planners have extensive experience conducting environmental review of development projects in accordance with the California Environmental Quality Act (CEQA) and the State CEQA Guidelines. Our planners know how to review a project and assess its potential environmental impacts. During our initial project review, we will determine whether an application qualifies as a “Project” under CEQA, and is therefore subject to further review. If so, we will then determine if the project is ‘Exempt’ from CEQA and prepare a Notice of Exemption. Factors to consider in determining if a project is exempt include if it is consistent with the General Plan and Zoning Ordinance, has no potential to generate environmental impacts and qualifies under an exemption category in the CEQA Guidelines.

For projects that are not exempt, our staff will conduct an Initial Study to determine if the project has the potential to create one or more potentially significant environmental impacts. If a project has the potential for environmental impact, we will identify whether mitigation measures are readily available and a Negative Declaration or a Mitigated Negative Declaration can be prepared. If not, we will determine that an Environmental Impact Report is required. In our experience, NDs, MNDs and EIRs are typically prepared by outside environmental consultants in which case we would review the documents for conformance with CEQA and City standards. We will coordinate all reviews and prepare the required documentation, including Notices of Preparation, Determination and Availability, as well as Mitigation, Monitoring and Reporting Programs, Findings and Statements of Overriding Considerations. We will also coordinate reviews with State and local agencies as needed, including the State Clearinghouse and Native American tribes.

In addition to all of our planners having experience using and working with CEQA, two of our team members are advanced CEQA practitioners. Albert Armijo and Chris Moore have extensive experience preparing the full range of CEQA documents, including Environmental Impact Reports (EIRs), for public and private sector clients. If the City desires a high level of CEQA expertise on a

project, Albert and Chris are available to provide that service.

Inspection Services

Civic Solutions planning staff will conduct inspections of residential, commercial and industrial sites prior to Building Final and/or Certificates of Occupancy. We will ensure development projects conform with approved plans, conditions of approval, other agreements and CEQA mitigation requirements. We will provide documentation of any issue areas in need of correction and document our inspections in the “Simplicity” tracking system as appropriate.

Customer Care

Civic Solutions applauds the City for adopting Customer Care Standards outlining how to provide excellent customer service to all the City’s customers. The City’s standards closely align with Civic Solutions own customer service standards. For 26 years, the firm has excelled at providing a high quality of service to our municipal clients AND their customers. We treat each and every applicant and community with the utmost courtesy and respect and carefully listen to their issues and concerns and provide accurate and timely information.

Electronic Plan Reviews

Civic Solutions is available to receive electronic plan submittals through emailed pdfs, and if available, a portal into the “Simplicity” case tracking system. Civic Solutions staff regularly utilizes municipal development tracking systems to access project plans, maintain case files, provide project comments and upload conditions of approval. If remote access to Simplicity is not available, staff will arrange to update the electronic tracking system at City Hall on a regular basis in accordance with the Time Schedules outlined in Section H.

In terms of project case tracking, Civic Solutions also maintains its own project tracking database to monitor workload, project reviews, turnaround times and invoicing. Reports can quickly be generated to summarize information in a variety of ways.

D. Personnel

Civic Solutions employs professional staff with a proven track-record of customer service and quality performance. Unlike some planning firms that provide as-needed staffing services using independent contractors, most of our planners are full-time employees. We provide our employees with competitive wages, flexible schedules, training and full benefits. We invest in our employees and believe they are our most important resource. Civic Solutions is pleased to present the organizational chart below outlining our proposed staffing plan for Moreno Valley.

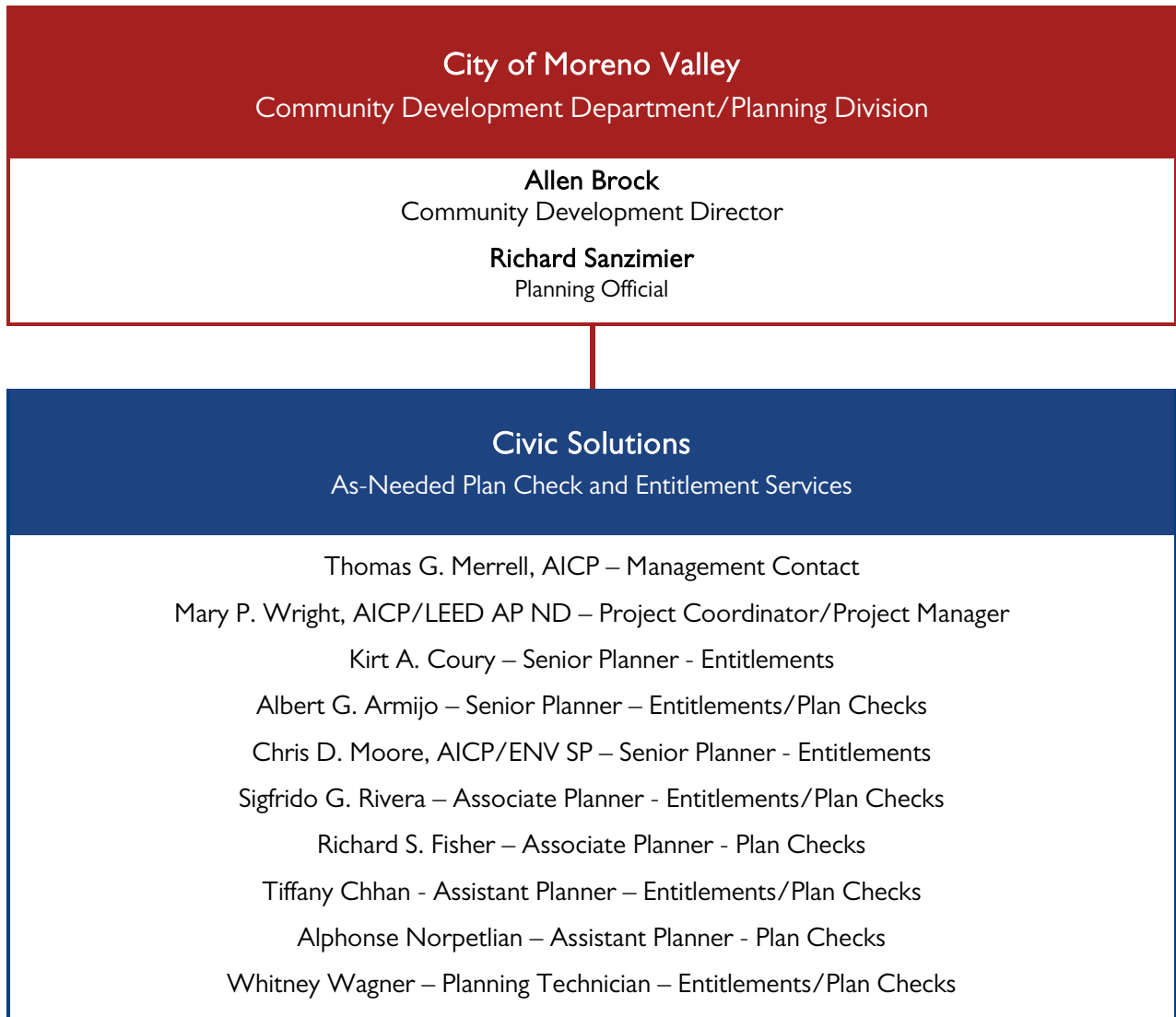

Attachment: Civic Solutions Moreno Valley Proposal FINAL (2886 : AUTHORIZATION TO AWARD PROJECT-RELATED SERVICES

The paragraphs below provide an overview of our team members backgrounds and their areas of responsibility. For a more detailed description of their qualifications and experience, please refer to the resumes in Appendix 2.

Thomas G. Merrell, AICP, is a leader in the planning field with more than 40 years of experience in public and private planning. Tom spent the first half of his career in municipal planning where he advanced to become the Director of Planning and Development for the City of San Juan Capistrano. In 1992, he utilized his experience and business/economic degree to found Civic Solutions, dedicated to serving municipal planning agencies. For the past 26 years, Civic Solutions has earned an enviable reputation providing the highest quality planning services to public agencies. In addition to managing Civic Solutions, Tom currently serves as the Planning Director of the City of Jurupa Valley where the firm provides all planning staff for the City.

Role on Project: Management Contact

Mary P. Wright, AICP/LEED AP ND, joined Civic Solutions in 2013 after a lengthy planning career in City government as a current, long range and environmental planner and project manager. Mary holds a B.A. in Geography and a Master's in City Planning and served for over 20 years with the City of San Diego where she most recently served as the Deputy Director of Planning for over five years. Mary serves as the firm's Vice President and Director of Planning Services, assisting with management of the company and coordinating municipal planning services. In addition, she provides high-level municipal planning services herself and recently completed work on the Jurupa Valley General Plan. She has excellent project management skills and is adept at providing oversight of team resources deployed at cities.

Project Role: Project Coordination/Project Management

Civic Solutions approaches every assignment with enthusiasm and professionalism. We work collaboratively with applicants, City staff and community members.

Kirt A. Coury began his career over 20 years ago by earning a degree in Urban and Regional Planning from CalPoly Pomona. From there, he tackled progressively responsible positions at cities throughout Riverside, Orange and San Bernardino Counties both as City staff and adjunct planning staff. Kirt provides exceptional current and environmental planning services and is embraced at every jurisdiction he works for. He is available to assist the City of Moreno Valley with some of their more complex planning projects. He expertly reviews projects for conformance with City standards, coordinates with other reviewing disciplines, works with applicants to revise projects to meet standards and takes projects through to completion.

Project Role: Senior Planner/Entitlements

Albert G. Armijo works extensively with Civic Solutions under a subconsultant agreement. He has over 30 years of experience in public and private planning including serving as the City of Aliso Viejo's Planning Director. Albert has extensive project review and environmental planning experience and has prepared environmental Negative Declarations, Mitigated Negative Declarations and Environmental Impact Reports (EIRs) for numerous projects. Albert enjoys the planning and project review process and is well versed at ensuring the project proposals meet local regulations and requirements. He is also fluent in both English and Spanish and often helps explain complex planning regulations to persons more fluent in Spanish.

Project Role: Senior Planner/Entitlements

Chris D. Moore, AICP/ENV SP, has a bachelor's degree in science and a Master's in City Planning and began his career working in City planning agencies. From there, he spent almost two decades refining his planning and environmental skills, primarily as a CEQA project manager and environmental analyst in the private sector. Chris has recently resumed working in municipal planning agencies and is available to conduct entitlement reviews, inspections and environmental analysis and documentation.

Project Role: Senior Planner/Entitlements

Richard S. Fisher has degrees in geography and planning and over 20 years of experience in current and advanced planning. His passion is government service and he has worked at several municipal planning agencies including Chino, Rancho Cucamonga, Ontario and Jurupa Valley. He is a skilled plan checker and project reviewer and is able to quickly get up to speed on a jurisdiction's requirements and identify project conformance with policies and regulations.

Project Role: Associate Planner/Plan Checks

Sigfrido G. Rivera has a Bachelor's degree in Urban Studies and a Master's in Urban and Regional Planning. He has almost 30 years of experience, primarily with the City of Ontario where he advanced from Assistant Planner to the City's Housing Manager. Like the rest of our team, Sigfrido enjoys performing plan checks, project reviews and inspections and works

with applicants to ensure their projects meet local policies and regulations.

Project Role: Associate Planner/Plan Checks

Tiffany Chhan has degrees in Ecology and Urban Planning and is proving herself to be a very capable current planner. She has municipal experience in the cities of Santa Ana, Rancho Santa Margarita and Jurupa Valley, as well as the Port of Long Beach. Tiffany excels at customer service and skillfully reviews plans for conformance with City policies and regulations.

Project Role: Assistant Planner/Entitlements/ Plan Checks

Alphonse Norpetlian has a degree in Urban and Regional Planning and experience working in Upland, Jurupa Valley and at the Southern California Association of Governments (SCAG). He has experience working at the Planning counter and performing plan checks and ministerial project reviews. Alphonse also has an expertise in geographic information systems (GIS) and is able to develop land use mapping and databases to assist in the analysis of planning issues.

Project Role: Assistant Planner/Plan Checks

Whitney Wagner is an emerging planning professional with growing experience performing plan checks and project reviews for our public agency clients.

Project Role: Planning Technician/Entitlements/Plan Checks

E. References

Civic Solutions invites the City of Moreno Valley to contact our client references to learn their opinion of our performance on past and present assignments.

City of Jurupa Valley
8930 Limonite Avenue
Jurupa Valley, CA 92509

Gary Thompson, City Manager
GThompson@jurupavalley.org
951/332-6464

Project Description: Civic Solutions has provided current, advanced and environmental planning services to the City of Jurupa Valley since 2011, completely managing and staffing the Planning Department. Services include, but are not limited to, public counter assistance, plan checks, discretionary case processing, environmental review and documentation and project management. In addition, Civic Solutions just completed a comprehensive update of the City's General Plan which was approved by the Jurupa Valley City Council on September 7, 2017.

City of San Clemente
910 Calle Negocio
San Clemente, CA 92672

Amber Gregg, City Planner
GreggA@san-clemente.org
949/361-6196

Project Description: Civic Solutions has provided planning and environmental contract staffing to the City of San Clemente for the past year. Our staff conducts ministerial and discretionary case management and environmental documentation from project submittal through public hearings and project close-out. In addition, our staff is currently managing a highly controversial sign program, providing much needed assistance to City staff.

City of Encinitas
505 South Vulcan Avenue
Encinitas, CA 92024

Roy Sapa'u, City Planner
RSapau@encinitasca.gov
760/633-2710

Project Description: Civic Solutions has provided planning contract staffing to the City of Encinitas periodically for the past two years. Our staff works as an extension of the Development Services Department providing ministerial and discretionary project review, public counter support, environmental documentation, long range policy preparation and analysis, project management, meetings with applicants, community outreach, public meetings and hearings, staff report preparation and related tasks.

Other Relevant Experience

In addition to the municipalities listed above, Civic Solutions has served numerous other municipalities over the past five years, including:

City of Montclair
Staff Augmentation, Associate Planner
2017

City of Oceanside
Staff Augmentation, Principal Planner
2014 - 2017

City of Downey
Land Use Study/Zoning Code Amendment
2016 - 2017

City of San Bernardino
Staff Augmentation, Project Management
2016

City of Cypress
Zoning Code Amendment/Analysis
2016

City of Pomona
Staff Augmentation, Project Management
2016

| | |
|---|--|
| City of Pomona Staff Augmentation, Associate Planner 2015 | City of El Cajon Staff Augmentation, Associate Planner 2014 |
| City of Lake Forest Staff Augmentation, Associate Planner 2015 | City of Compton Staff Augmentation, Senior Planner 2014 |
| City of Yorba Linda Assessment Permit Inspection and Entitlement Process 2015 | City of Fountain Valley Development Process Study 2014 |
| City of Covina Staff Augmentation, Project Manager, Housing Development 2015 | City of Inglewood Staff Augmentation, Assistant Planner 2014 |
| City of Buena Park Staff Augmentation, Associate Planner 2015 | City of Compton Annexation Fiscal Analysis 2013 |
| City of Glendale So. Glendale Land Use Study, Principal Project Manager 2014 | City of Yorba Linda Staff Augmentation, Associate Planner 2013 |
| City of Huntington Beach Planning Department Assessment 2014 | City of La Habra Heights Staff Augmentation, Project Manager 2013 |
| City of Sierra Madre Staff Augmentation, Assistant Planner 2014 | City of La Puente Interim Community Development Director 2013 |
| | City of Irvine Staff Augmentation, Senior Planner 2013 |

F. Authorization

I, Thomas G. Merrell, confirm that the terms and conditions of this proposal are valid and binding and capable of being accepted by the City through January 31, 2018.

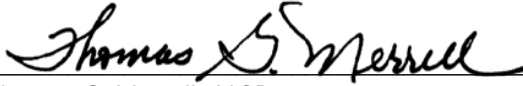

Thomas G. Merrell, AICP
President
Civic Solutions, Inc.

G. Fee Schedules

Civic Solutions fee schedules are outlined in the table below. In addition, we will coordinate the pick-up and delivery of all plans via Civic Solutions staff or licensed courier at no cost to the City.

| Review Type | Fee or Hourly Rate* |
|--|---------------------|
| Plan Checks and Inspections | |
| Standard Plan Checks/Inspections | 65% of City's Fee |
| Expedited Plan Checks/Inspections | 90% of City's Fee |
| Entitlement Processing | |
| Fixed-Fee Entitlement Processing | 65% of City's Fee |
| Expedited Fixed-Fee Entitlement Processing | 90% of City's Fee |
| Deposit-Based Entitlement Processing | |
| Senior Planner | \$105/hour |
| Associate Planner | \$90/hour |
| Assistant Planner | \$80/hour |
| Planning Technician | \$70/hour |
| Expedited Deposit-Based Entitlement Processing | |
| Senior Planner | \$125/hour |
| Associate Planner | \$110/hour |
| Assistant Planner | \$100/hour |
| Planning Technician | \$90/hour |

**Rates are guaranteed for the first year of the contract. Thereafter, hourly rates are subject to annual review and potential adjustment in consultation with the City.*

H. Time Schedules

Civic Solutions takes pride in delivering quality project reviews in a timely manner. The timelines outlined below represent our maximum project review timelines, however, we will typically turn around our reviews in a fraction of the time indicated.

| Review Type | Timeline (Working Days) |
|---------------------------------------|----------------------------|
| Plan Checks | |
| Standard Plan Checks | |
| Pick-up from City | Day 2 |
| 1 st Review/Return to City | Day 8 |
| Subsequent Reviews/Return to City | Day 5 |
| Expedited Plan Checks | |
| Pick-up from City | Day 2 |
| 1 st Review/Return to City | Day 4 |
| Subsequent Reviews/Return to City | Day 3 |
| Entitlement Processing | |
| Standard Entitlement Processing | |
| Pick-up from City | Day 2 |
| 1 st Review | Day 12 |
| Subsequent Reviews | Day 8 |
| Expedited Entitlement Processing | |
| Pick-up from City | Day 2 |
| 1 st Review | Day 4 |
| Subsequent Reviews | Day 3 |

**Note – Day 1 represents the date the City receives the plans for review*

I. Transportation of Plans

As outlined in the RFP, limited office space at City Hall may be available, but is not guaranteed, for plan checks and entitlement reviews. When space is available, Civic Solutions staff will work out of City Hall and maintain project files and materials at the City.

Plan checks and entitlement reviews performed off-site will be transported to one of our offices via Civic Solutions staff or licensed courier. Depending upon the staff member assigned to the project, plans will either be transported to our company headquarters in San Juan Capistrano or our satellite office in Ontario.

Civic Solutions will develop a comprehensive tracking system to monitor the status and location of all plans, and ensure the turn around times outlined in Section H. Mary P. Wright will supervise staff in both offices to ensure the quality and timeliness of plan reviews.

Please note, if Civic Solutions begins to handle a large volume of plan checks and entitlement reviews for the City, we will explore opening a satellite office in Moreno Valley near City Hall to further simplify and expedite the review process.



Civic Solutions' San Juan Capistrano Office



Civic Solutions' Ontario Office

Required Forms

- 1) Non-Collusion Affidavit
- 2) Affidavit of Non-Conviction
- 3) Vendor Information Page
- 4) References

RFP 2018-006

NON-COLLUSION AFFIDAVIT

STATE OF CALIFORNIA)
COUNTY OF) SS

(NAME) , affiant being first
duly sworn, deposes and says:

That he or she is of
(sole owner, partner or other proper title)
Thomas G. Merrell the party making the foregoing Proposal
(Contractor)

that the bid is not made in the interest of, or on behalf of, any undisclosed person,
partnership, company, association, organization, or corporation; that the bid is genuine
and not collusive or sham; that the bidder has not directly or indirectly induced or
solicited any other bidder to put in a false or sham bid, and has not directly or indirectly
colluded, conspired, connived, or agreed with any bidder or anyone else to put in a
sham bid, or that anyone shall refrain from bidding; that the bidder has not in any
manner, directly or indirectly sought by agreement, communication, or conference with
anyone to fix the bid price of the bidder or any other bidder, or to fix any overhead,
profit, or cost element of the bid price, or of that of any other bidder, or to secure any
advantage against the public body awarding the Contract of anyone interested in the
proposed contract; that all statements contained in the bid are true; and, further, that the
bidder has not, directly or indirectly, submitted his or her bid price or any breakdown
thereof, or the contents thereof, or divulged information or data relative thereto, or paid,
and will not pay, any fee to any corporation, partnership, company associations,
organization, bid depository, or to any member or agent thereof to effectuate a collusive
or sham bid (Public Contract Code Section 7106).

Proposer's Name: Civic Solutions, Inc.
(print)
Proposer's Address: 27362 Calle Arroyo, San Juan Capistrano, CA 92675
(print)

Telephone No.: 949/489-1442

Thomas G. Merrell President
(Signature of Proposer) (Title)

All signatures must be notarized.
Attach Notary here.

Attachment: Civic Solutions MorenoValley Proposal FINAL (2886 : AUTHORIZATION TO AWARD PROJECT-RELATED SERVICES

CALIFORNIA ALL-PURPOSE ACKNOWLEDGMENT

CIVIL CODE § 1189

A notary public or other officer completing this certificate verifies only the identity of the individual who signed the document to which this certificate is attached, and not the truthfulness, accuracy, or validity of that document.

State of California)
County of Orange)
On Oct. 9th 2017 before me, Colleen D. Stormans, Notary Public
Date Here Insert Name and Title of the Officer
personally appeared Thomas G. Merrell
Name(s) of Signer(s)

who proved to me on the basis of satisfactory evidence to be the person(s) whose name(s) is/are subscribed to the within instrument and acknowledged to me that he/she/they executed the same in his/her/their authorized capacity(ies), and that by his/her/their signature(s) on the instrument the person(s), or the entity upon behalf of which the person(s) acted, executed the instrument.

I certify under PENALTY OF PERJURY under the laws of the State of California that the foregoing paragraph is true and correct.

WITNESS my hand and official seal.



Signature Colleen D. Stormans
Signature of Notary Public

Place Notary Seal Above

OPTIONAL

Though this section is optional, completing this information can deter alteration of the document or fraudulent reattachment of this form to an unintended document.

Description of Attached Document

Title or Type of Document:
Document Date: Number of Pages:
Signer(s) Other Than Named Above:

Capacity(ies) Claimed by Signer(s)

Signer's Name:
[] Corporate Officer — Title(s):
[] Partner — [] Limited [] General
[] Individual [] Attorney in Fact
[] Trustee [] Guardian or Conservator
[] Other:
Signer Is Representing:

Attachment: Civic Solutions Moreno Valley Proposal FINAL (2886 : AUTHORIZATION TO AWARD PROJECT-RELATED SERVICES

RFP 2018-006

AFFIDAVIT OF NON-CONVICTION

I hereby affirm that:

I am the President and the he duly authorized
(Title)

Representative of the firm of Civic Solutions, Inc.

Whose address is: 27362 Calle Arroyo, San Juan Capistrano, CA 92675
And that

I possess the legal authority to make this affidavit on behalf of myself and the firm for which I am acting.

Except as described in paragraph 3 below, neither I nor the above firm, nor to the best of my knowledge, and of its officers, directors, or partners, or any of its employees directory involved in obtaining Contracts with the City have been convicted of, or have plead *no/o contendere* to a charge of, or having during the course of an official investigation or other proceeding admitted in writing or under oath acts or omissions which constitute bribery, attempted bribery, or conspiracy to bride under the laws of any State of the Federal government (conduct prior to July 1, 1977 is not required to be reported).

State "none" or, as appropriate, list any convection, plea or admission described in paragraph two above, with the data, court, official, or administrative body; the individuals involved and their position with the firm, and sentence or disposition, if any. NONE

I acknowledge that this affidavit is required to allow the City to make a determination. I acknowledge that, if the representations set forth in the affidavit are not true and correct, the City may terminate ant Contract awarded and may take any other action.

I do solemnly declare and affirm under the penalties of perjury that the contents of this affidavit are true and correct.

Signature: Thomas G. Merrell Date: 10/12/17

Printed Name Thomas G. Merrell Title: President

Name of firm: Civic Solutions, Inc.

Attachment: Civic Solutions MorenoValley Proposal FINAL (2886 : AUTHORIZATION TO AWARD PROJECT-RELATED SERVICES

RFP2018-006

VENDOR INFORMATION

A. PROPOSERS COMPANY INFORMATION (print or type)

Company Name: Civic Solutions, Inc.

Owner / Manager Name: Thomas G. Merrell, Owner Mary Wright, Manager

PO Mailing Address: 27362 Calle Arroyo

City: San Juan Capistrano State CA Zip 92675

Remit to Address (if different from PO mailing address)

PO Mailing Address: _____

City: _____ State _____

Web Site: www.civicsolutions.com

Phone Number: 949/489-1442

Fax Number: 949/240-8068

E-mail Address: wright@civicsolutions.com

Incorporated? (mark one) Yes X or No ___

Fed. Tax I.D. # or Social #: 33-0689860

If not a Corporation, are you a Partnership, LLC, Individual or Joint Venture? _____

How many years of relevant experience within the scope of this RFP? 26

I certify that the information given above is accurate and complete; that the Terms and Conditions as issued by the City of Moreno Valley with this Request for Proposal # RFP 2018-006 have been fully read, understood, and accepted in total; and that I am a duly authorized agent for quoting purposes for the company named above.

Thomas G. Merrell President

(Print Quoting Persons Name)

(Title)

Thomas G. Merrell

10/12/17

(Quoting Persons Signature)

(Date)

Attachment: Civic Solutions Moreno Valley Proposal FINAL (2886 : AUTHORIZATION TO AWARD PROJECT-RELATED SERVICES

RFP 3018-006

REFERENCES

List three (3) references that most closely reflect similar projects and work that your company has worked on within the past five (5) years for a Public or Governmental Agency. (Type or Print)

1. Name of Public Agency: City of Jurupa Valley

Address: 8930 Limonite Avenue

City: JurupaValley State: CA Zip: 02509

Telephone: (951) 332-6464

Service Dates: 7/01/2012 to Present

Brief Summary of Project/Work provided: Civic Solutions has provided the entire Jurupa Valley Planning Department staff since 2012. Duties include entitlement processing, plan checks, counter support, site visits, inspections, CEQA review and advanced planning

2. Name of Public Agency: City of San Clemente

Address: 910 Calle Negocio, Suite 100

City: San Clemente State: CA Zip: 92672

Telephone: (949) 361-6184

Service Dates: 9/22/2016 to Present

Brief Summary of Project/Work provided: Ministerial and discretionary case processing, CEQA review, plan checks, site inspections, project tracking and project management.

Attachment: Civic Solutions MorenoValley Proposal FINAL (2886 : AUTHORIZATION TO AWARD PROJECT-RELATED SERVICES

RFP 3018-006

3. Name of Public Agency: City of Encinitas

Address: 505 S. Vulcan Avenue

City: Encinitas State: CA Zip: 92024

Telephone: (760) 633-2710

Service Dates: 10/30/2015 to 9/22/2016 (Contract currently being renewed).

Brief Summary of Project/Work provided: Ministerial and discretionary case processing, plan checks, project tracking and monitoring.

Attachment: Civic Solutions Moreno Valley Proposal FINAL (2886 : AUTHORIZATION TO AWARD PROJECT-RELATED SERVICES

Appendices

Appendix I – Letters of Recommendation

The letters of recommendation listed below are provided on the following pages:

- Gary Thompson, City Manager, City of Jurupa Valley
- Amber Gregg, City Planner, City of San Clemente

Appendix 2 – Resumes

Our team member resumes listed below are also provided on the following pages:

- Thomas G. Merrell, AICP
- Mary P. Wright, AICP/LEED AP ND
- Kirt A. Coury
- Albert G. Armijo
- Chris D. Moore, AICP/ENV SP
- Richard S. Fisher
- Sigfrido G. Rivera
- Tiffany Chhan
- Alphonse Norpetlian
- Whitney Wagner

Appendix I Letters of Recommendation



City of San Clemente Planning

Amber Gregg, City Planner
Phone: (949) 361-6196 Fax: (949) 361-8309
gregga@san-clemente.org

Wednesday, October 11, 2017

Subject: Letter of Recommendation for Civic Solutions, Inc.

To Whom It May Concern:

This letter is to recommend the professional planning services of Civic Solutions, Inc. For the past year, Civic Solutions has provided an Associate Planner to assist with the Planning Division's workload and augment the City's current planning staffing resources. Their staff member fits seamlessly into the organization and provides excellent planning services. Duties include, but are not limited to: ministerial and discretionary project review and analysis; interdepartmental coordination; project tracking through the TRAKIT Permitting System; site visits; CEQA review; plan checks; preparation of staff reports, environmental documentation, resolutions and conditions; presentations at public hearings and responding to public inquiries. Their staff is qualified and professional and represents the City well.

In addition to providing an Associate Planner, since June of this year Civic Solutions has provided a part-time Senior Planner to manage a controversial commercial sign program. Their staff member handles all aspects of this complex project including review for conformance with City policies and regulations, presentations to public meetings and hearings and responding to constituents.

Civic Solutions consistently provides planning services with a high degree of professionalism, competence and efficiency. Their staff members function as an extension of City staff and meet our expectations in all aspects of their services.

Sincerely,

Amber Gregg
City Planner

Planning 910 Calle Negocio, Suite 100 San Clemente, CA 92673
<http://san-clemente.org>

Attachment: Civic Solutions Moreno Valley Proposal FINAL (2886 : AUTHORIZATION TO AWARD PROJECT-RELATED SERVICES

City of Jurupa Valley

Verne Lauritzen, Mayor . Micheal Goodland, Mayor Pro Tem .
 Brian Berkson, Council Member . Anthony Kelly, Jr., Council Member . Laura Roughton, Council Member

October 10, 2017

Subject: References for Civic Solutions, Inc.

To Whom It May Concern:

Civic Solutions, Inc. has provided all municipal planning services for the City of Jurupa Valley since its incorporation in 2011. The City has contracted with Civic Solutions for a full service Planning Department, CEQA administration and preparation of the City's first comprehensive General Plan. Civic Solutions' staff, including Planning Director, professional planners and support personnel, provide the full range of city planning functions. Civic Solutions' services to the City of Jurupa Valley include public counter services, plan checking, ministerial and discretionary case processing, land use analysis, environmental review and documentation, site visits, inspections, advanced planning and special projects.

Civic Solutions staff members have consistently demonstrated the necessary training and experience to meet the City's planning needs. They work well with City staff, project applicants, community members and decisionmakers and know how to interpret the City's policies and regulations. Their staff reports and presentations are well written and professional and clearly convey the necessary information.

Civic Solutions has provided outstanding planning services to the City of Jurupa Valley. I believe other public agencies will find this firm to be well qualified in all areas of professional city planning. If you have any questions, please do not hesitate to contact me at (951) 332-6464 or gthompson@jurupavalley.org.

Sincerely,

 Gary S. Thompson
 City Manager

8930 Limonite Ave., Jurupa Valley, CA 92509-5183
 Phone: (951) 332-6464, FAX (951) 332-6995
www.jurupavalley.org

Attachment: Civic Solutions MorenoValley Proposal FINAL (2886 : AUTHORIZATION TO AWARD PROJECT-RELATED SERVICES

Appendix 2 Resumes



Highlights

- Contract oversight
- Planning and public administration
- Staff training & professional development

Certifications

American Institute of Certified Planners (AICP)

Education

Bachelor of Arts, Business Administration, California State University, Long Beach

Certificate in Urban Planning, University of California, Irvine

Certificate in Community Planning Process, University of California, Irvine

Affiliations

American Planning Association

American Institute of Certified Planners

Publications

APA Viewpoints:
Outsourcing in the Planning Department
(<http://www.planning.org/viewpoints/outourcing.htm>).

THOMAS G. MERRELL, AICP

MANAGEMENT CONTACT

Mr. Merrell completed twenty-eight years of public service in March of 1991 when he retired from the City of San Juan Capistrano to establish Civic Solutions, Inc. In addition to his fifteen years as the City's Director of Community Planning and Development, he served in professional and administrative positions with the County of Orange and the City of Garden Grove. During his career, he has developed expertise in all aspects of planning and public administration. His experience includes long range physical and policy planning, development review, building and safety administration, urban design, zoning, citizen participation and consensus building, redevelopment, growth management and environmental preservation.

Mr. Merrell is a member of the American Planning Association and a charter member of the American Institute of Certified Planners (AICP). He has served as the president of the Orange County Planning Directors Association and on the APA Awards Judging Panel. In San Juan Capistrano, he has served on numerous committees, such as the Downtown Merchants Committee, the Flood Plain Management Committee, and the Sign Ordinance Review Committee. His long association with public administration and professional planning has given him a broad range of capabilities in these areas.

Highlights of Mr. Merrell's experience include:

Civic Solutions, Inc., Principal, 1991 - present. Provides corporate management, staff development, and contract administration for the firm. Provides urban planning services to public agencies, homeowner associations, and expert witness and research services to law firms for cases involving land use and zoning.

City of San Juan Capistrano, Director of Community Planning and Development, 1976 - 1991. Department head for City planning, redevelopment and building and safety functions; served as Secretary to the Planning Commission and Deputy Director of the Community Redevelopment Agency.

City of Garden Grove, Land Use Manager, 1970 - 1976. As Manager of the Land Use Division, responsible for all current planning and code enforcement functions, served as Secretary to the Planning Commission.

County of Orange, Land Use Planner, 1963 - 1970. Staff level planning, and served as interim Administrative Services Officer.

CIVIC SOLUTIONS, INC. 



Highlights

- Leadership
- Project Management
- Quality Control
- General Plans
- Community Plans
- Specific Plans
- Development Regulations
- Environmental Planning
- Policy Planning
- Strategic Land Use Planning
- Entitlements
- Government Relations
- Public Facilitation

Education

Master of City Planning with Distinction, San Diego State University, San Diego, CA
 Bachelor of Arts, Geography with Environmental Emphasis, San Diego State University, San Diego, CA

Accreditations & Certifications

Accredited, LEED AP ND (Neighborhood Development)
 Certified, International Association for Public Participation (IAP2)
 Certified, National Charrette Institute (NCI)
 Certified, American Institute of Certified Planners (AICP)
 American Planning Association, (APA) Associate Member
 Association of Environmental Professionals (AEP), Member

MARY P. WRIGHT, AICP/LEED AP ND

PROJECT COORDINATOR/PROJECT MANAGER

Ms. Wright is a planning professional with 30 years of planning and environmental experience in Southern California including public and private sector work serving municipal planning agencies. Ms. Wright has a demonstrated knowledge of the principles, practices and trends in urban planning along with strong public participation and facilitation skills. Her extensive comprehensive planning background and outstanding written, verbal and interpersonal communication skills are highlighted at City Council, Planning Commission and other public meetings. During her tenure with the City of San Diego, she progressed from an Associate Planner to the Deputy Director of Planning responsible for long range planning within the City.

Highlights of Ms. Wright's experience include:

Civic Solutions, Inc., Vice President/Director of Planning Services, 2016 - Present. Responsible for managing the firm's planning and staffing operations and performing higher-level urban planning consulting services for the company's clients. As a Project Manager, Ms. Wright is retained by public agencies to manage planning efforts including the preparation of General Plans, Community Plans and Specific Plans. She is adept at formulating work plans that meet the needs of the jurisdiction and are technically sound and visionary. She also coordinates and performs advanced planning services and discretionary case processing for cities.

Civic Solutions, Inc., Director of Planning Services, 2013 – 2015. Responsible for performing higher-level urban planning consulting services for public planning agencies including the preparation of General Plans, General Plan Elements and Community Plans. She also conducted reviews of complex discretionary permit applications and managed all aspects of the project review process from initial submittal to in-depth review and presentations to decision makers. She also assisted municipal planning agencies assess their organizational structures for maximum efficiency and effectiveness.

City of San Diego, Deputy Planning Director, 2007 – 2012. Managed 44-member, \$8 million budgeted division including management, professional and administrative staff. Directed long range planning activities including the preparation of comprehensive Community Plans for several large communities within the City. She was also responsible for directing general and mobility planning, multiple species habitat preservation, historic review, park planning, budgeting and administration. Served as planning management liaison to the Planning Commission and City Council. Directed project management responsibilities, consultant contracting and budgeting. Served as liaison to the Labor Relations Department and supervised the division's personnel practices. Oversaw the community planning group system with over 40 active groups. Coordinated planning activities with other departments and agencies. Developed long range planning programs, zoning ordinances, policies and procedures.

CIVIC SOLUTIONS, INC. 



**Mary P. Wright,
AICP/LEED AP ND**

City of San Diego, Planning Program Manager, 2001 – 2007. Managed community planning activities in the southern half of the City of San Diego. Supervised a diverse staff responsible for updating plans and reviewing development projects and planning documents. Developed policy and zoning recommendations related to public and private development. Prepared and presented reports to the Planning Commission and City Council.

City of San Diego, Planning Program Manager/Community Service Manager, 1998 – 2001. Served concurrently in two related management roles for the City of San Diego. Established and managed the Mid-City Community Service Center, providing City services to a dense neighborhood of the City. Coordinated with agencies, non-profit groups and other stakeholders on neighborhood issues. Supervised professional staff responsible for planning in the central urbanized core of the City. Served as the Department's grant coordinator involving researching grant opportunities, applying for grants and negotiating with granting agencies.

City of San Diego, Livable Neighborhoods Coordinator, 1996 – 1998. Coordinator of a comprehensive program to bring together eight interdisciplinary teams of City staff to address neighborhood problems. Developed the prototype for Revitalization Action Plans (RAPs) to document and prioritize community needs and target municipal services. Oversaw the preparation of eight RAPs for specific areas of the City. Managed the \$3 million Neighborhood Revitalization Superfund and coordinated with elected officials to identify and fund neighborhood projects. Led the Mid-City Livable Neighborhoods team.

City of San Diego, Senior Planner, 1989 – 1996. Served as the lead long-range planner for multiple communities in the City. Managed the preparation of the Mid-City Communities Plan. Prepared the Mission Valley Planned District Ordinance (zoning ordinance). Reviewed development proposals for conformance with City of San Diego planning policies.

City of San Diego, Associate Planner, 1986 – 1989. Served as an environmental analyst and a coastal permit planner. Evaluated and documented the environmental effects of development proposals pursuant to CEQA. Assisted with the successful City effort to secure coastal permitting authority from the California Coastal Commission. Processed coastal permits for private development proposals.

CIVIC SOLUTIONS, INC. 



Highlights

- Discretionary Case Processing
- Research and Analysis
- Public Counter Support
- Zoning Review
- Land Entitlement
- Project Review
- Advanced Planning
- Project Management
- Environmental Review

Education

Bachelor of Science, Urban and Regional Planning, California Polytechnic Institute, Pomona, California

Affiliations

Certified, American Institute of Certified Planners (AICP)
Member, American Planning Association (APA)

KIRT A. COURY

SENIOR PLANNER

Mr. Coury brings over twenty years of planning experience in the public sector. He has served in a variety of roles with the cities of Lake Forest, San Clemente, Encinitas, Compton, Lake Elsinore, Calexico, Rancho Cucamonga, Brea, and other municipalities. His experience has included both current and advanced planning, the preparation of environmental documentation, providing public counter services and conducting complex assignments. He has reviewed Environmental Impact Reports (EIRs) and Mitigated Negative Declarations (MNDs) to ensure completeness and compliance with the California Environmental Quality Act (CEQA).

Highlights of Mr. Coury's experience include:

Civic Solutions, Inc., Senior Planner, 2015 - Present. Provides associate and senior level urban planning services to our public agency clients. Duties include advanced planning, current planning, preparation of specific plans, general plan amendments, design guidelines, CEQA review and the preparation of NDs, MNDs and EIRs. He coordinates with applicants, design professionals and the public on projects and issues. He also prepares staff reports, resolutions and conditions of approval and makes presentations to city councils, planning commissions and other public decision-making bodies.

Coury Planning and Environmental, Senior Planner, 2003 – 2014. Provided contract planning services for the following clients:

City of Lake Elsinore – Was responsible for project review, staff report and noticing preparation, compilation of project conditions and presentation of staff reports at public hearings. Processed current and advanced planning applications, including general plan amendments, zoning code amendments, mining and reclamation projects, specific plans, annexations, conditional use permits, variances, design reviews, and tentative tract maps. Prepared Initial Studies, Notices of Preparation, NDs and MNDs for discretionary projects and ensured that CEQA requirements were met. Was responsible for the review and preparation of Multiple Species Habitat Conservation Plan (MSHCP) information for compliance and consistency with the Riverside Conservation Authority.

City of Calexico - Processed current and advanced planning applications, and assisted with the General Plan Update; was responsible for the City's update of the expansion of the Sphere of Influence area and coordinated preparation of the Service Area Plan. Worked with the County LAFCO and Planning Department. Assisted in the review of environmental documents for the City.

County of Imperial - Assisted with the review of development applications and conditional use permits. Assisted with the preparation of Initial Studies, Notices of Preparation, NDs and MNDs for discretionary projects.

CIVIC SOLUTIONS, INC. 



Kirt A. Coury

City of Rancho Cucamonga, Community Development Department, Associate Planner, 2000 – 2003. Conducted complex assignments involving current planning projects. Conferred with applicants and agency representatives to identify development issues. Served as a project manager for major assignments and programs which included the preparation of reports and presentations including related recommendations. Evaluated current development projects for general plan, zoning and design compliance. Performed field surveys to ensure conformance with applicable requirements. Discussed recommendations with builders, developers, architects, engineers and the general public. Interpreted planning policies, state laws, and local ordinances, as well as performed environmental analysis for compliance with CEQA Guidelines.

City of Brea, Community Development Department, Assistant Planner, 1999-2000. Prepared, reviewed and analyzed development plans, site plans, building plans, parcel maps, and other development proposals for compliance with the general plan, zoning and other City regulations and policies. Identified the need for conditional use permits, variances and design review for specific projects. Responded to inquiries at the public counter and in writing. Conducted site inspections for development projects for compliance with approved plans. Prepared and presented reports to the Planning Commission.

City of Norco, Community Development Department, Assistant Planner, 1995-1999. Conducted planning studies in the community to gather data for evaluating current and advanced planning projects and issues including environmental assessments, regional or local area planning issues and other related topics. Researched, analyzed, and interpreted socioeconomic and land use data trends. Developed and presented reports and recommendations to the City Council, Planning Commission and community groups on current and advanced planning issues.

City of Montclair, Community Development Department, Planning Technician, 1994 Prepared environmental studies, site, landscape and irrigation plans for City capital projects; evaluated current development projects and prepared recommendations on development applications for use permits, variances, rezonings, subdivisions, signs and architectural review.

CIVIC SOLUTIONS, INC. 



Highlights

- Land Use/Development Review
- Environmental Review
- Entitlements
- Project Management
- Public Outreach/Consensus Building
- General Plan/Specific Plan Updates
- Fluent in Spanish

Education

Bachelor of Arts, (2), History and Comparative Culture, University of California, Irvine

Master of Arts, History and American Studies, Indiana University

All but Dissertation, Comparative Racial and Ethnic Studies and History, University of California Berkeley

Affiliations

American Planning Association, Member
Southern California Planning Congress, Member

ALBERT G. ARMIJO

SENIOR PLANNER

Mr. Armijo brings over 35 years of professional experience in land use and environmental planning. He has served in a variety of lead roles at the City of Aliso Viejo and the County of Orange. He has also held private staff support positions for the cities of Yorba Linda, Dana Point, Costa Mesa, Anaheim, Lake Forest, West Covina, and, Downey. In addition to his public sector experience, Mr. Armijo has worked as an entitlement consultant/project manager for private development projects in Orange, Riverside and San Diego counties. In both his public and private sector work he has created and coordinated project work teams, managed entitlement processes, composed land use regulations, policies, procedures and planning studies, conducted various levels of environmental analyses, composed environmental documents in compliance with CEQA and NEPA regulations, worked with community and private interest groups, conducted detailed public presentations on behalf of jurisdictions and private clients, and performed project advocacy.

Highlights of Mr. Armijo's experience include:

Civic Solutions, Inc., Senior Planner, 2015 - present. Provides urban planning services to our public agency clients under a sub-consultant agreement. Duties include advance planning, current planning, specific plans, general plan amendments, urban design, architectural and landscape design review, CEQA review and preparation of mitigated negative declarations and environmental impact reports. Mr. Armijo commands a strong public presentation presence, brings proven analytical and writing skills, and is a seasoned team leader.

City of Aliso Viejo, Director of Planning Services, 2009 – 2015. Responsibilities included the following: supervising daily and long-term work of City Planning Department staff; developing and implementing annual and short-term Planning Department work objectives; preparing annual Planning Department budgets; serving as Project Manager leading City and technical consultant work teams on complex, long-term projects; coordinating and reviewing work of professional and technical (contract) consultants related to planning analyses, plan formulations and data collection; supervising, training and evaluating professional, technical and clerical staff; administering technical consultants' contracts; developing Requests for Proposals for long-term projects; applying for various federal and State planning grant programs; conducting project-related community meetings and public presentations; preparing and delivering oral and written presentations to the City Council; implementing City Manager policies and directions; and, representing the Planning Department and City at various meetings and regional/state functions.

Armijo Associates, Principal, 1999 – 2009. Responsible for project entitlement management, coordination and processing for various public sector Clients. Provided staff support services, including processing all levels of discretionary entitlement applications, composing all levels of environmental analyses, composing reports about State legislation, regional

CIVIC SOLUTIONS, INC. 



Albert G. Armijo

planning studies, and demographics, assisted in composing Local Coastal Programs and General Plan Housing Elements, and conducting presentations before design review groups, Planning Commissions and City Councils.

Secured approvals for large-scale project entitlements and related environmental documentation, which required selecting and directing technical consultant work teams, conducting due diligence investigations to assess the feasibility of development potential, establishing productive advocacy relationships with community groups, local and state agencies, and conducting presentations before discretionary boards and community groups. Composed specific plans and environmental documents.

CIVIC SOLUTIONS, INC. 

Attachment: Civic Solutions MorenoValley Proposal FINAL (2886 : AUTHORIZATION TO AWARD PROJECT-RELATED SERVICES



Highlights

- Development Review
- Project Management
- Development Regulations
- Environmental Planning
- Policy Planning
- Strategic Land Use Planning
- Entitlements
- Regulatory review & compliance
- Community Outreach Relations
- Public Facilitation

Education

Master of Science,
Community & Regional
Planning, University of
Texas, Austin, Texas

Bachelor of Arts,
Environmental Biology &
Environmental Conservation
(double major), University of
Colorado, Boulder, Colorado

Certifications & Memberships

Certified, Envision
Sustainability Professional
(ENV SP), 2015

Certified, American Institute
of Certified Planners (AICP),
2002

American Planning
Association (APA),
Associate Member

Association of
Environmental Professionals
(AEP), Member

CHRIS D. MOORE, AICP/ENV SP

SENIOR PLANNER

Mr. Moore is a planning professional with over 20 years of planning and environmental experience. He has a demonstrated knowledge of principles, practices and trends in urban planning along with strong analytical skills. Mr. Moore is a proven leader and manager with an in-depth knowledge of planning practices and environmental requirements.

Highlights of Mr. Moore's experience include:

Civic Solutions, Inc., Senior Planner, 2017. Mr. Moore serves as an Senior Planner for Civic Solutions. In this role he serves as adjunct staff to cities and counties personally providing current and advanced planning services. Duties include public counter support, project review and analysis, preparation of notices, staff reports and resolutions and making presentations to decision makers. He also is experienced in preparing the full range of environmental documents under CEQA and works on specific plans, general plans and urban design guidelines. Mr. Moore commands a strong public presentation presence, brings proven analytical and writing skills, and is a seasoned team leader.

LSA Associates, Sr. Environmental Planner/Project Manager, 2016 - 2017

Project Manager focusing on projects involving planning, CEQA/NEPA, environmental permitting, and various supporting technical studies. Responsible for business development activities for CEQA, NEPA projects, and related technical studies. Examples of projects include: California High Speed Rail – Bakersfield to Palmdale Segment EIS/EIR (Environmental Justice, Socioeconomics & Communities, Station Planning and Land Use), and California High Speed Rail – Burbank to Palmdale Segment EIS/EIR (Community Impact Assessment, Environmental Justice, Socioeconomics & Communities, Station Planning and Land Use).

ATKINS, Project Director, 2016. Served as a Project Director focusing on projects involving planning, CEQA/NEPA, environmental permitting, and various supporting technical studies. Was a planning lead and supervised planners and technical experts. Managed a variety of projects including the County of San Diego Property Specific Request Subsequent EIR; the City of Solana Beach Dahlia Street Mixed-Use Development EIR; the Palomar Community College District South Education Center EIR; and the Otay Water District Master Plan Update Programmatic EIR.

TRC Solutions, Inc., Senior Project Manager, 2013 – 2015. Senior Project Manager focusing on projects involving planning and environmental compliance, permitting and mitigation. Served as Planning, Permitting and Licensing Lead for the San Diego office. Supervised a team of biologists. Was responsible for business development activities for planning and environmental projects. Representative projects included: the First Solar Desert Quartzite Project; and SDG&E's Sycamore Canyon to Pecos Environmental Assessment.

CIVIC SOLUTIONS, INC. 



CHRIS D. MOORE

URS Corporation, Senior Project Manager, 2012 – 2013. Served as a Senior Project Manager for projects involving planning, CEQA/NEPA and environmental compliance, permitting, and mitigation. Achieved URS Certified Project Manager status in 2012. Was responsible for business development activities for planning and environmental projects. Examples of projects included: the Basewide Bicycle Network Master Plan for Marine Corps Base Camp Pendleton; and the Kinder Morgan Calnev Pipeline Project; and the Schneider Electric Wind Energy Project.

AECOM, Senior Project Manager/Associate, 2007 – 2011. Project manager for numerous small and large-scale planning and environmental projects including general plans, complex CEQA and NEPA documents and various technical studies. Managed the work of multidisciplinary teams and sub-consultants. Projects involved preparation of general plans and analysis of solar power plants, electrical transmission lines; highway improvements; off-highway vehicle recreation; and Indian Casinos.

PBS&J, Project Manager, 2000 - 2007. Served as Project Manager/Leader for PBS&J offices in Nevada and Texas. Managed a variety of projects involving environmental compliance, permitting, planning and public outreach. Managed several projects to provide 3rd-party oversight for recreation projects involving environmental compliance, permitting, agency coordination and planning within Clark County, Nevada. Was a part of the office leadership team and involved in decisions related to business development, recruitment and office management.

Ogden Environmental & Energy Services and SWCA Environmental Consultants, Environmental Planner, 1999 - 2000. Task Manager/Environmental Planner for variety of environmental compliance and planning projects related to NEPA and CEQA, and involving multidisciplinary teams. Responsible for developing proposals and other business development activities.

City of Cedar Park, Texas, Planning Department, Planner, 1998 - 1999. Responsible for subdivision, zoning, site plan, and transportation review of proposed development projects. Made monthly presentations and recommendations to the Planning and Zoning Commission on development applications. Coordinated with developers to discuss proposed subdivisions, zoning changes and site plans. Helped prepare ordinances, including the corridor overlay zone, sign, and tree ordinances.

City of Round Rock, Texas, Planner, 1995 - 1998. Served as a planner responsible for wide variety of planning and development related projects. Provided assistance to the public for subdivision, zoning, site plan, neighborhood planning and development related inquiries. Organized and facilitated a neighborhood planning program for three neighborhood plans involving Neighborhood Planning Teams. Prepared neighborhood plans based on input from teams. Conducted a land use inventory of the City and integrated it into the City's GIS system. Also developed a GIS-based historic preservation inventory for the City.

CIVIC SOLUTIONS, INC. 

Attachment: Civic Solutions MorenoValley Proposal FINAL (2886 : AUTHORIZATION TO AWARD PROJECT-RELATED SERVICES



Highlights

- Project Management
- Project Review
- Advanced Planning
- Discretionary Case Processing
- Research and Analysis
- Zoning Review
- Code Enforcement Review
- Public Counter Support
- CDBG Manager

Education

Master of Arts, Urban Planning,
University of California Los Angeles, Los Angeles, California

Bachelor of Arts, Geography,
California State University Fullerton, Fullerton, California

Post Secondary Education, Urban Studies, Introduction to Geographic Information Systems
University of California at Riverside, Riverside, California

Affiliations

American Planning Association, Member

RICHARD S. FISHER

ASSOCIATE PLANNER

Mr. Fisher brings over twenty-five years of planning experience in the public and private sectors. He has served in a variety of roles with the cities of Chino, Rancho Cucamonga, Rancho Santa Margarita, Ontario, Norwalk, and Jurupa Valley. His experience has included both current and advanced planning, the preparation of general and specific plan documentation, and managing complex development projects.

Highlights of Mr. Fisher's experience include:

Civic Solutions, Inc., Associate Planner, 2015 - Present. Provides associate and senior level urban planning services to our public agency clients. Duties include project management of residential, commercial, and industrial developments. Prepares staff reports for, and makes presentations to, planning commissions and city councils. Reviews and comments on general and specific plan amendments; assists code enforcement officers interpret zoning codes in regard to code violations and works with residents and business owners who are in violation of codes resolve issues and comply with zoning codes.

City of Chino, Associate Planner, 2003 – 2015. Project manager for residential, commercial, and industrial developments. Responsible for managing a 1,400-acre specific plan which included the construction of 2,200 residential units. Implemented a development agreement for the specific plan and made revisions to the agreement. Also was responsible for overseeing the environmental Mitigation Monitoring and Reporting Program (MMRP) for the specific plan. Served as the project manager for over 500,000-square-feet of industrial development. Met with developers during the initial planning stages and conducted site development review. Took projects to the Planning Commission for approval and conducted final occupancy inspections for residential, commercial, and industrial development projects. Assisted and worked closely with the Code Enforcement Department on code violation cases throughout the City. Met with business owners and citizens to discuss code violation cases and determined methods for resolution. Served as manager of the City's CDBG program. Oversaw the expenditure of over \$450,000 in CDBG funding annually to local non-profit agencies and city-funded programs.

Civic Solutions, Associate Planner, 2001 – 2003. Provided current planning services to several Southern California cities including the cities of Norwalk, Rancho Cucamonga and Rancho Santa Margarita. Reviewed and commented on development applications; prepared staff reports and presented development applications to planning commissions and city councils; assisted code enforcement agencies at each city with resolving code enforcement issues; met with residents and businesses to resolve code issues in order to comply with the existing zoning codes.

CIVIC SOLUTIONS, INC. 



Richard S. Fisher

City of Ontario, Assistant/Associate Planner, 1987-1990 and 1994-2000.

Participated in current and advanced planning duties as assigned. Acted as a member of the General Plan Update team; reviewed the draft General Plan and provided comments to the consultant; prepared for and attended all General Plan Advisory Board public hearings. Reviewed residential, commercial, and industrial development applications and prepared staff reports for presentations to the Planning Commission. Assisted the Code Enforcement Department with code violation issues and met with citizens and businesses to resolve code issues and make sure their property complied with the zoning code.

CIVIC SOLUTIONS, INC. 

Attachment: Civic Solutions Moreno Valley Proposal FINAL (2886 : AUTHORIZATION TO AWARD PROJECT-RELATED SERVICES



Highlights

- Land Use/Development Review
- Entitlement Review
- Project Management
- Public Outreach/Consensus Building
- General Plan/Specific Plan Updates
- Fluent in Spanish

Education

Master of Urban and Regional Planning, California State Polytechnic University, Pomona, CA

Bachelor of Arts, Urban Studies, California State University, Northridge, CA

Affiliations

American Planning Association

SIGFRIDO G. RIVERA

ASSOCIATE PLANNER

Mr. Rivera brings 29 years of professional experience in municipal planning, project management, land development, and airport noise mitigation/land use compatibility. He has extensive experience in current and advance planning involving residential, commercial, office, industrial and land subdivision projects. Mr. Rivera assisted in the successful completion and approval of the City of Ontario 1993 General Plan Update/EIR Project and coordinated the initial phase of a city wide zoning consistency program. He has over five years experience in managing and completing the land acquisition, business/residential relocation, EIR preparation and site clearance/demolition components of the Ontario Town Square mixed use project. He negotiated and managed a disposition and development agreement to redevelop a 16-acre site into a business park, which is currently under construction near Ontario International Airport. He secured over \$126 million in FAA and LAWA grant funding for airport noise mitigation.

Highlights of Mr. Rivera's experience include:

Civic Solutions, Inc., Associate Planner, 2016 – Present. Provides urban planning services to our public agency clients. Duties include advance planning, current planning, counter services, specific plans, general plan amendments, urban design, architectural and landscape design review. Mr. Rivera commands a strong public presentation presence, brings proven analytical and writing skills, and is a seasoned team leader.

City of Ontario, Housing Manager, 2007 - 2015. Responsible for grant administration, budgeting, land development, land acquisition, relocation contract administration, property maintenance, construction administration and report preparation. Processed and reviewed land development applications and prepared staff reports for the Development Review Board, Planning Commission and City Council. Provided project coordination with city staff, consultants, public agencies, and the general public. Served as Project Manager for planning, real estate development, land acquisition, relocation, environmental testing, site clearance/demolitions, and construction projects. Administered and implemented federal and airport grant funded projects. Maintained project budget preparation, and technical and clerical staff supervision. Provided bilingual (English/Spanish) interpretation and translation for the general public, city officials, and community outreach efforts involving planning and airport noise mitigation projects.

City of Ontario, Senior Project Manager, 2001 - 2007. Managed the land acquisition/relocation, environmental remediation, EIR preparation and site clearance activities of the City's major downtown residential project. Served as the City's Housing Agency/Code Enforcement representative on the Development Advisory Board and reviewed all development applications on

CIVIC SOLUTIONS, INC. 



behalf of the Agency and Code Enforcement. Managed the Airport Noise Mitigation Program and prepared budgets and staff reports for the City Council.

City of Ontario, Project Manager, 1998 - 2001. Managed the day-to-day implementation of the airport noise mitigation program. Prepared Airport Noise Program Advisory Committee reports and special airport noise compatibility studies. Prepared program budgets and managed construction and consultant contracts. Conferred with airport and FAA officials. Supervised program staff and reviewed assigned work.

City of Ontario, Senior Project Coordinator, 1994 – 1998. Coordinated the day-to-day implementation of the City's first airport noise mitigation program (residential sound insulation and voluntary relocation/land recycling components). Prepared grant applications to secure program funding from the FFA and Los Angeles World Airports. Coordinated all public bidding efforts and procurement of consultant contracts. Assisted Program Administrator in budget preparations and staff supervision. Responded to inquiries from the general public about the program.

City of Ontario, Senior Planner, Advance Planning, 1992 – 1994. Assisted with the coordination of all aspects of the General Plan Update Program, General Plan EIR and Citywide Zoning Consistency Program. Oversaw General Plan Update consultant contracts. Assisted in preparation public workshops and public hearings related to the General Plan Update Program. Coordinated review comments and prepared responses related to the General Plan Update Program. Assisted in preparing recommendations on proposed goals, objectives and policies for all General Plan elements.

City of Ontario, Associate Planner, Current and Advance Planning, 1989 - 1992. Reviewed larger site development proposals (i.e., shopping centers, industrial parks, business parks, residential condominiums, planned unit developments, etc.). Prepared staff reports and recommendations on zoning matters, site development proposals, tentative tract and parcel maps, variances, conditional use permits, land use studies, and signage programs for commercial and industrial developments. Reviewed General Plan amendments, zone change proposals, specific plans, EIR's and downtown design guidelines. Met and conferred with City departmental staff, developers, consultants, and public agencies. Made presentations to the Development Advisory Board, Planning Commission and City Council.

City of Ontario, Assistant Planner, Current Planning, 1986 – 1989. Reviewed site development proposals (site plans, tentative tract and parcel maps) for various residential, commercial and industrial projects. Reviewed variance and conditional use permit applications. Prepared written reports for the Development Advisory Board and Planning Commission. Advised property owners, developers and the general public on zoning requirements. Assisted with special assignments (land use studies, building permit research, census data gathering, etc.). Also prepared and assisted with preparing materials for presentations to the Development Advisory Board and Planning Commission.

CIVIC SOLUTIONS, INC. 



Highlights

- Public Counter Support
- Plan Check and review
- Research and Analysis
- Discretionary case processing
- Regulatory review and compliance
- Community Outreach
- Conversational Cantonese and American Sign Language
- Technical Skills: ESRI ArcGIS, Photoshop, Microsoft Office Suite

Education

Master of Arts, Urban and Regional Planning
University of California, Irvine

Bachelor of Science, Ecology, Behavior, and Evolution
University of San Diego

Certificate of Proficiency in Sustainability and Resource Management, Irvine Valley College

Affiliations

American Planning Association

TIFFANY CHHAN

ASSISTANT PLANNER

Tiffany Chhan has performed administrative and technical services for the Port of Long Beach and the cities of Rancho Santa Margarita, Santa Ana and Jurupa Valley. Ms. Chhan is a motivated urban and regional planning graduate with organizational skills and experience in urban and environmental planning including processing plans, research and analysis, community outreach, and regulatory inspections. She has strong research and analytical skills and has coordinated and conducted community meetings.

Highlights of Ms. Chhan's experience include:

Civic Solutions, Inc., Assistant Planner, 2016 – Present. Duties include public counter support, entry-level project management for code compliance and discretionary case processing and assisting in the preparation of planning reports including making recommendations and preparing supporting data for approval. Assists applicants and consultants understand municipal requirements, analyze issues and develop solutions and strategies to meet local policies and regulations. Attends meetings and provides presentations to Planning Commissions and other decision-making bodies.

Port of Long Beach, Planning and Environmental Affairs, Administrative Intern, 2015 – 2016. Responsible for processing project plans in compliance with the Port Master Plan, the City's General Plan, and environmental policies adopted by the Port, the City, the California Coastal Act, CEQA and NEPA. Communicated between permittees and Port departments to fully understand projects on Port lands and interpret Port regulations to permittees. Created and maintained databases (i.e. Port mitigation measures, SCAQMD comments, interoffice orders, etc.). Performed research and analysis of the costs and benefits of a potential desalination plant. Supported staff through information retrieval and review of environmental documents, real estate documents, and external documents to ensure consistency of service.

Rancho Santa Margarita, Department of Public Works, Environmental Intern, 2014. Tracked construction and demolition diversion rates between waste haulers and the City. Analyzed the City's solid waste ordinance for conflicts with current policies and recommended revisions. Researched and developed a food waste program, solid waste community newsletter and internal solid waste documents.

City of Santa Ana Public Works, Solid Waste Intern, 2013 – 2014. Conducted community outreach to commercial businesses via phone surveys. Communicated between the general public and the City. Responsible for data collection and documentation of implemented recycling programs at local businesses.

CIVIC SOLUTIONS, INC. 



Tiffany Chhan

US Department of Agriculture, Agricultural Aide, 2012 – 2013. Executed regulatory inspections, compliance agreements and quarantine activities. Observed treatment of infested plants, interpreted treatment information, documented daily activities, sampled the collection of live insects and leaves, and collected data. Trained coworkers in similar tasks, including regulatory inspections, quarantine activities, sample and data collection, and measurement. Enforced quarantine and regulatory rules and issued warnings and violations as necessary. Developed skills in organization and time management and coordinated between different agencies and public, state, and federal offices.

CIVIC SOLUTIONS, INC. 

Attachment: Civic Solutions MorenoValley Proposal FINAL (2886 : AUTHORIZATION TO AWARD PROJECT-RELATED SERVICES



Highlights

- Public Counter Support
- GIS mapping
- Housing Site Analysis
- Research & Analysis
- Zoning Inventory
- Discretionary Case Processing
- Regulatory Review and Compliance

Education

Bachelor of Science, Urban and Regional Planning
California State Polytechnic University, Pomona, CA

Technical Skills

Architectural Drafting
Revit/Sketch Up
AutoCAD
MS Office Suite
ARC GIS
R programming
Python
CS6
Spatial Analysis
Network Analysis
Geocoding
Model Builder
Geodatabase
Raster Data
Remote Sensing

Affiliations

American Planning Association

ALPHONSE NORPETLIAN

ASSISTANT PLANNER

Alphonse Norpetlian has over two years of experience in municipal urban planning, research, data analysis and geographic information systems (GIS). He is a motivated urban and regional planning graduate with organizational skills in the analysis and interpretation of social, economic, population and land use data and trends. He has helped maintain and update general plans, zoning maps and development codes and has trained other staff members in using GIS software. Alphonse is flexible, attentive to details, adaptable and has strong problem-solving and presentation skills.

Highlights of Mr. Norpetlian's experience include:

Civic Solutions, Inc., Planning Technician/Assistant Planner, 2017. Duties include public counter support, entry-level project management for ministerial and discretionary case processing, assisting with the preparation of planning reports including recommendations and supporting data for approval and presentation to Planning Commissions and other public hearings. Provides assistance to applicants and consultants in understanding municipal requirements, analyzes issues and recommends solutions and strategies. Attends meetings and provides presentations.

City of Jurupa Valley, GIS Technician Intern, 2016 - 2017. Responsible for the creation of a geodatabase for the General Plan Update. Collected and interpreted geographical data for urban planning use. Prepared a GIS Public Counter Map booklet and grid index. Assisted the Planning Department with related GIS mapping needs as well as maintenance and update of the General Plan and Zoning and Development Code. Updated and maintained files and maps on specific development projects. Trained staff in using GIS software. Created a mobility corridor map for the City and performed a Housing Site Analysis. Made presentations before the Mayor and Council members.

Southern California Association of Governments (SCAG), 2016. Extracted, compiled, tracked and analyzed data to generate reports. Worked with other team members to complete special projects and performed daily data queries. Researched, analyzed and interpreted social, economic, population and land use data and trends. Created, maintained and updated GIS data and supported in statistical analysis. Performed a zoning inventory for jurisdictions within Riverside, Los Angeles and San Bernardino counties.

City of Upland, Planning Intern, 2016. Conducted field work, collected parcel data and searched land records. Conducted basic office functions as needed, such as data entry and management. Provided information on General Plan, Specific Plan, and Zoning information to the general public, residents, and property owners.

CIVIC SOLUTIONS, INC. 



Highlights

- Public Counter Support
- Mapping
- Plan Checks
- Ministerial Project Review
- Customer Service
- Research
- Analysis

Education

Bachelor of Arts,
Environmental Studies with
a Minor in Geography,
California State University,
San Bernardino, CA
(December, 2017)

Technical Skills

MS Office Suite
ARC GIS

WHITNEY WAGNER

PLANNING TECHNICIAN

Ms. Wagner is an emerging planning professional with a passion for working in the public sector. Scheduled to earn her Bachelor's degree in December of 2017, Ms. Wagner is already working in the public sector, providing entry level planning assistance to a burgeoning city of 100,000. She is a solid researcher and analyst, and provides excellent service to the public.

Highlights of Ms. Wagner's experience include:

Civic Solutions, Inc., Planning Technician, 2017. Works at the City of Jurupa Valley performing a variety of duties in support of the Planning Department. Work includes responding to public inquiries, research and analysis, plan checks and entry-level project management. Provides assistance to applicants and consultants in understanding municipal requirements, analyzing issues and recommending solutions and strategies. Also attends meetings and provides presentations.

California State University San Bernardino, Student Educator, 2016 – Present. Serves as a student volunteer educating the community on sustainable practices. Also organizes and contributes to community clean-ups.

Fisheries Resource Volunteer Corps, Volunteer, 2015. Participated in stream patrols to protect and monitor wild trout streams in the Angeles and San Bernardino National Forests. Also worked on various conservation projects.

CIVIC SOLUTIONS, INC. 

MORENO VALLEY

SERVICE THAT SOARS

Customer Care Standards

In Moreno Valley, we provide exceptional customer care by...

Providing same day response Resolving an issue or completing a request is seldom accomplished in just a day, but striving to acknowledge the request the day it is received provides “same day response” and exemplary service.

Knowing first impressions matter Our professionalism is judged based on appearance, attitude, manners, knowledge, and abilities. It is a package; we risk making a bad impression if we fail on even one count.

Ensuring a positive experience A negative attitude affects service quality and morale. We resolve to stay positive because we know our approach dramatically affects our customers’ and coworkers’ experience.

Asking and listening We never assume to know what our customers need. Good questions evoke good answers, but only if we listen. Resolving to not interrupt, we exercise patience and we pay attention.

Connecting We make eye contact, smile, and acknowledge every customer. When speaking to a customer, we address them by name using formal address (e.g. Mr. or Ms.), and let them decide if we’re on a first name basis.

Respecting our customers’ concerns To some, government can seem like a complex bureaucracy. We put a human face on the customer’s dealings with our City. We work to put our customers at ease and to earn their trust.

Treating customers like they have a choice Customers of government agencies often do not choose to do business with us, they have to. We meet this challenge by providing exceptional service.

Remembering who we work for It may not always be possible to say “yes” but our customers and co-workers must know that we have done our best to help them accomplish their goal.

Knowing our business To provide accurate information, we must know our jobs and have a thorough understanding of agency processes. Providing accurate information is critical; to do so, we work with staff, consult supervisors, conduct research, and keep up-to-date with industry best practices.

Understanding the difference between fast and efficient service We use knowledge, skills, and resources to respect our customers’ time, but we never rush – it is impolite and it dramatically impacts the relationship and the outcome.

Questioning the status quo We do not do things the same old way just because that is “how we’ve always done it. We were hired to use our experience and skills to improve public service – and we take the process improvement challenge to heart.

Keeping our word We manage expectations by setting reasonable goals. Giving careful thought to timelines, we always remember that our word is our bond as we promote honesty, responsibility, and accountability.

Treating customers like people, not footballs Customers notice how many interactions are required to get the answers they need. If we need to hand off a customer, it should be to the right person, and that person should be provided with the pertinent facts to ensure a seamless transition.

Seeing the big picture Identifying improvement opportunities throughout the organization requires a field of vision that expands beyond one’s workstation. “That’s not my job” is not part of our vocabulary. We engage, participate, and contribute.

Encouraging feedback Comments, suggestions, and criticism help us measure our success and promote improvement. We demonstrate commitment to our customers by asking how we can do better.

Saying “Thank you” Technical knowledge simply isn’t enough; our careers and livelihood depend on our success in providing exceptional customer care. At every opportunity, we show sincere care, compassion, gratitude and appreciation. We go above and beyond to provide “service that soars.”

**AGREEMENT FOR PLANNING ENTITLEMENT AND PLAN CHECK SERVICES
ON AN AS NEEDED BASIS**

This Agreement is by and between the City of Moreno Valley, California, a municipal corporation, hereinafter described as "City," and Annealta Group, a California corporation, hereinafter described as "Consultant." This Agreement is made and entered into effective on the date the City signs this Agreement.

RECITALS

WHEREAS, the City has determined it is in the public interest to proceed with the professional work hereinafter described as "Project"; and

WHEREAS, the City has determined the Project involves the performance of professional and technical services of a temporary nature as more specifically described in Exhibit "A" (Scope of Work); and

WHEREAS, the City does not have available employees to perform the services for the Project; and

WHEREAS, the City has requested the Consultant to perform such services for the Project; and

WHEREAS, the Consultant is professionally qualified in California to perform the professional and technical services required for the Project, and hereby represents that it desires to and is professionally and legally capable of performing the services called for by this Agreement;

THEREFORE, the City and the Consultant, for the consideration hereinafter described, mutually agree as follows:

**AGREEMENT FOR PLANNING ENTITLEMENT
AND PLAN CHECK SERVICES ON AN AS NEEDED BASIS**

DESCRIPTION OF PROJECT

1. The Project is described as Planning Entitlement and Plan Check Services on an As-Needed Basis.

SCOPE OF SERVICES

2. The Consultant's scope of service is described on Exhibit "A" attached hereto and incorporated herein by this reference.

3. The City's responsibility is described on Exhibit "B" attached hereto and incorporated herein by this reference.

PAYMENT TERMS

4. The City agrees to pay the Consultant and the Consultant agrees to receive a "Not-to-Exceed" fee of \$375,000 (\$75,000 for the first year, and \$75,000 annually for each fiscal year for a period not to exceed four (4) additional years) in accordance with the payment terms provided on Exhibit "C" attached hereto and incorporated herein by this reference.

TIME FOR PERFORMANCE

5. The Consultant shall commence services upon receipt of written direction to proceed from the City.

6. The Consultant shall perform the work described on Exhibit "A" in accordance with the schedule set forth in Exhibit "A" attached hereto and incorporated by this reference.

7. This Agreement shall be effective from effective date and shall continue in full force and effect date through **June 30, 2018**, subject to any earlier termination in accordance with this Agreement.

(a) This Agreement shall be automatically renewed annually at the end of each fiscal year for a period not to exceed four (4) additional years, provided that funding appropriations and program approvals have been granted by the City Council and if no written

**AGREEMENT FOR PLANNING ENTITLEMENT
AND PLAN CHECK SERVICES ON AN AS NEEDED BASIS**

notice of termination is received by either party. This Agreement shall be renewed on the same condition until a new Agreement is fully executed or until terminated as provided for in this Agreement.

(b) The services of Consultant shall be completed in a sequence assuring expeditious completion, but in any event, all such services shall be completed prior to expiration of this Agreement.

8. (a) The Consultant agrees that the personnel, including the principal Project manager, and all subconsultants assigned to the Project by the Consultant, shall be subject to the prior approval of the City.

(b) No change in subconsultants or key personnel shall be made by the Consultant without written prior approval of the City.

SPECIAL PROVISIONS

9. It is understood and agreed that the Consultant is, and at all times shall be, an independent contractor and nothing contained herein shall be construed as making the Consultant or any individual whose compensation for services is paid by the Consultant, an agent or employee of the City, or authorizing the Consultant to create or assume any obligation or liability for or on behalf of the City.

10. The Consultant may also retain or subcontract for the services of other necessary consultants with the prior written approval of the City. Payment for such services shall be the responsibility of the Consultant. Any and all subconsultants employed by the Consultant shall be subject to the terms and conditions of this Agreement, except that the City shall have no obligation to pay any subconsultant for services rendered on the Project.

11. The Consultant and the City agree to use reasonable care and diligence to perform their respective services under this Agreement.

**AGREEMENT FOR PLANNING ENTITLEMENT
AND PLAN CHECK SERVICES ON AN AS NEEDED BASIS**

12. The Consultant shall comply with applicable federal, state, and local laws in the performance of work under this Agreement.

13. To the extent required by controlling federal, state and local law, Consultant shall not employ discriminatory practices in the provision of services, employment of personnel, or in any other respect on the basis of race, religious creed, color, national origin, ancestry, physical disability, mental disability, medical condition, marital status, sex, age, sexual orientation, ethnicity, status as a disabled veteran or veteran of the Vietnam era. Subject to the foregoing and during the performance of this Agreement, Consultant agrees as follows:

(a) Consultant will comply with all applicable laws and regulations providing that no person shall, on the grounds of race, religious creed, color, national origin, ancestry, physical disability, mental disability, medical condition, marital status, sex, age, sexual orientation, ethnicity, status as a disabled veteran or veteran of the Vietnam era be excluded from participation in, be denied the benefits of, or be subject to discrimination under any program or activity made possible by or resulting from this Agreement.

(b) Consultant will not discriminate against any employee or applicant for employment because of race, religious creed, color, national origin, ancestry, physical disability, mental disability, medical condition, marital status, sex, age, sexual orientation, ethnicity, status as a disabled veteran or veteran of the Vietnam era. Consultant shall ensure that applicants are employed, and the employees are treated during employment, without regard to their race, religious creed, color, national origin, ancestry, physical disability, mental disability, medical condition, marital status, sex, age, sexual orientation, ethnicity, status as a disabled veteran or veteran of the Vietnam era. Such requirement shall apply to Consultant's employment practices including, but not be limited to, the following: employment, upgrading, demotion or transfer; recruitment or recruitment advertising; layoff or termination; rates of pay

AGREEMENT FOR PLANNING ENTITLEMENT AND PLAN CHECK SERVICES ON AN AS NEEDED BASIS

or other forms of compensation; and selection for training, including apprenticeship. Consultant agrees to post in conspicuous places, available to employees and applicants for employment, notices setting forth the provision of this nondiscrimination clause.

(c) Consultant will, in all solicitations or advertisements for employees placed by or on behalf of Consultant in pursuit hereof, state that all qualified applicants will receive consideration for employment without regard to race, religious creed, color, national origin, ancestry, physical disability, mental disability, medical condition, marital status, sex, age, sexual orientation, ethnicity, status as a disabled veteran or veteran of the Vietnam era.

(d) If Consultant should subcontract all or any portion of the services to be performed under this Agreement, Consultant shall cause each subcontractor to also comply with the requirements of this Section 13.

14. To the furthest extent allowed by law (including California Civil Code section 2782.8 if applicable), Consultant shall indemnify, hold harmless and defend the City, the Moreno Valley Community Services District (“CSD”), the Moreno Valley Housing Authority (“Housing Authority”) and each of their officers, officials, employees, agents and volunteers from any and all loss, liability, fines, penalties, forfeitures, costs and damages (whether in contract, tort or strict liability, including but not limited to personal injury, death at any time and property damage), and from any and all claims, demands and actions in law or equity (including reasonable attorney's fees and litigation expenses) that arise out of, pertain to, or relate to the negligence, recklessness or willful misconduct of Consultant, its principals, officers, employees, agents or volunteers in the performance of this Agreement.

If Consultant should subcontract all or any portion of the services to be performed under this Agreement, Consultant shall require each subcontractor to indemnify, hold harmless and defend City, CSD, Housing Authority and each of their officers, officials, employees, agents

**AGREEMENT FOR PLANNING ENTITLEMENT
AND PLAN CHECK SERVICES ON AN AS NEEDED BASIS**

and volunteers in accordance with the terms of the preceding paragraph.

This section shall survive termination or expiration of this Agreement.

15. Insurance.

(a) Throughout the life of this Agreement, Consultant shall pay for and maintain in full force and effect all insurance as required in **Exhibit D** or as may be authorized in writing by the City Manager or his/her designee at any time and in his/her sole discretion.

(b) If at any time during the life of the Agreement or any extension, Consultant or any of its subcontractors fail to maintain any required insurance in full force and effect, all services and work under this Agreement shall be discontinued immediately, and all payments due or that become due to Consultant shall be withheld until notice is received by City that the required insurance has been restored to full force and effect and that the premiums therefore have been paid for a period satisfactory to City. Any failure to maintain the required insurance shall be sufficient cause for City to terminate this Agreement. No action taken by City pursuant to this section shall in any way relieve Consultant of its responsibilities under this Agreement. The phrase "fail to maintain any required insurance" shall include, without limitation, notification received by City that an insurer has commenced proceedings, or has had proceedings commenced against it, indicating that the insurer is insolvent.

(c) The fact that insurance is obtained by Consultant shall not be deemed to release or diminish the liability of Consultant, including, without limitation, liability under the indemnity provisions of this Agreement. The duty to indemnify City shall apply to all claims and liability regardless of whether any insurance policies are applicable. The policy limits do not act as a limitation upon the amount of indemnification to be provided by Consultant. Approval or purchase of any insurance contracts or policies shall in no way relieve from liability nor limit the liability of Consultant, its principals, officers, agents, employees, persons under the

**AGREEMENT FOR PLANNING ENTITLEMENT
AND PLAN CHECK SERVICES ON AN AS NEEDED BASIS**

supervision of Consultant, vendors, suppliers, invitees, consultants, sub-consultants, subcontractors, or anyone employed directly or indirectly by any of them.

(d) Upon request of City, Consultant shall immediately furnish City with a complete copy of any insurance policy required under this Agreement, including all endorsements, with said copy certified by the underwriter to be a true and correct copy of the original policy. This requirement shall survive expiration or termination of this Agreement.

(e) If Consultant should subcontract all or any portion of the services to be performed under this Agreement, Consultant shall require each subcontractor to provide insurance protection in favor of City and each of its officers, officials, employees, agents and volunteers in accordance with the terms of this section, except that any required certificates and applicable endorsements shall be on file with Consultant and City prior to the commencement of any services by the subcontractor.

16. The waiver by either party of a breach by the other of any provision of this Agreement shall not constitute a continuing waiver or a waiver of any subsequent breach of either the same or a different provision of this Agreement. No provisions of this Agreement may be waived unless in writing and signed by all parties to this Agreement. Waiver of any one provision herein shall not be deemed to be a waiver of any other provision herein.

17. Consultant and subconsultants shall pay prevailing wage rates when required by the Labor Laws of the State of California.

18. (a) The Consultant shall deliver to the Planning Official or his designee, fully completed and detailed project-related documents which shall become the property of the City. The Consultant may retain, for its files, copies of any and all material, including drawings, documents, and specifications, produced by the Consultant in performance of this Agreement.

(b) The Consultant shall be entitled to copies of all furnished materials for his

**AGREEMENT FOR PLANNING ENTITLEMENT
AND PLAN CHECK SERVICES ON AN AS NEEDED BASIS**

files and his subconsultants, if any.

(c) The City agrees to hold the Consultant free and harmless from any claim arising from any unauthorized use of computations, maps, and other documents prepared or provided by the Consultant under this Agreement, if used by the City on other work without the permission of the Consultant. Consultant acknowledges that Consultant work product produced under this agreement may be public record under State law.

19. (a) This Agreement shall terminate without any liability of City to Consultant upon the earlier of: (i) Consultant's filing for protection under the federal bankruptcy laws, or any bankruptcy petition or petition for receiver commenced by a third party against Consultant; (ii) 10 calendar days prior written notice with or without cause by City to Consultant; (iii) City's non-appropriation of funds sufficient to meet its obligations hereunder during any City fiscal year of this Agreement, or insufficient funding for the Project; or (iv) expiration of this Agreement. The written notice shall specify the date of termination. Upon receipt of such notice, the Consultant may continue services on the project through the date of termination, provided that no service(s) shall be commenced or continued after receipt of the notice, which is not intended to protect the interest of the City. The City shall pay the Consultant within thirty (30) days after the date of termination for all non-objected to services performed by the Consultant in accordance herewith through the date of termination. Consultant shall not be paid for any work or services performed or costs incurred which reasonably could have been avoided.

(b) In the event of termination due to failure of Consultant to satisfactorily perform in accordance with the terms of this Agreement, City may withhold an amount that would otherwise be payable as an offset to, but not in excess of, City's damages caused by such failure. In no event shall any payment by City pursuant to this Agreement constitute a waiver

**AGREEMENT FOR PLANNING ENTITLEMENT
AND PLAN CHECK SERVICES ON AN AS NEEDED BASIS**

by City of any breach of this Agreement which may then exist on the part of Consultant, nor shall such payment impair or prejudice any remedy available to City with respect to the breach.

(c) Upon any breach of this Agreement by Consultant, City may (i) exercise any right, remedy (in contract, law or equity), or privilege which may be available to it under applicable laws of the State of California or any other applicable law; (ii) proceed by appropriate court action to enforce the terms of the Agreement; and/or (iii) recover all direct, indirect, consequential, economic and incidental damages for the breach of the Agreement. If it is determined that City improperly terminated this Agreement for default, such termination shall be deemed a termination for convenience.

(d) Consultant shall be liable for default unless nonperformance is caused by an occurrence beyond the reasonable control of Consultant and without its fault or negligence such as, acts of God or the public enemy, acts of City in its contractual capacity, fires, floods, epidemics, quarantine restrictions, strikes, unusually severe weather, and delays of common carriers. Consultant shall notify City in writing as soon as it is reasonably possible after the commencement of any excusable delay, setting forth the full particulars in connection therewith, and shall remedy such occurrence with all reasonable dispatch, and shall promptly give written notice to Administrator of the cessation of such occurrence.

20. This Agreement is binding upon the City and the Consultant and their successors and assigns. Except as otherwise provided herein, neither the City nor the Consultant shall assign, sublet, or transfer its interest in this Agreement or any part thereof without the prior written consent of the other.

21. A City representative shall be designated by the City and a Consultant representative shall be designated by the Consultant. The City representative and the Consultant representative shall be the primary contact person for each party regarding

**AGREEMENT FOR PLANNING ENTITLEMENT
AND PLAN CHECK SERVICES ON AN AS NEEDED BASIS**

performance of this Agreement. The City representative shall cooperate with the Consultant, and the Consultant's representative shall cooperate with the City in all matters regarding this Agreement and in such a manner as will result in the performance of the services in a timely and expeditious fashion.

22. This Agreement represents the entire and integrated Agreement between the City and the Consultant, and supersedes all prior negotiations, representations or Agreements, either written or oral. This Agreement may be modified or amended only by a subsequent written Agreement signed by both parties.

23. Where the payment terms provide for compensation on a time and materials basis, the Consultant shall maintain adequate records to permit inspection and audit of the Consultant's time and materials charges under this Agreement. The Consultant shall make such records available to the City at the Consultant's office during normal business hours upon reasonable notice. Nothing herein shall convert such records into public records. Except as may be otherwise required by law, such records will be available only to the City. Such records shall be maintained by the Consultant for three (3) years following completion of the services under this Agreement.

24. The City and the Consultant agree, that to the extent permitted by law, until final approval by the City, all data shall be treated as confidential and will not be released to third parties without the prior written consent of both parties.

25. (a) Consultant shall comply, and require its subcontractors to comply, with all applicable (i) professional canons and requirements governing avoidance of impermissible client conflicts; and (ii) federal, state and local conflict of interest laws and regulations including, without limitation, California Government Code Section 1090 et. seq., the California Political Reform Act (California Government Code Section 87100 et. seq.) and the regulations

**AGREEMENT FOR PLANNING ENTITLEMENT
AND PLAN CHECK SERVICES ON AN AS NEEDED BASIS**

of the Fair Political Practices Commission concerning disclosure and disqualification (2 California Code of Regulations Section 18700 et. seq.). At any time, upon written request of City, Consultant shall provide a written opinion of its legal counsel and that of any subcontractor that, after a due diligent inquiry, Consultant and the respective subcontractor(s) are in full compliance with all laws and regulations. Consultant shall take, and require its subcontractors to take, reasonable steps to avoid any appearance of a conflict of interest. Upon discovery of any facts giving rise to the appearance of a conflict of interest, Consultant shall immediately notify City of these facts in writing.

(b) In performing the work or services to be provided hereunder, Consultant shall not employ or retain the services of any person while such person either is employed by City or is a member of any City council, commission, board, committee, or similar City body. This requirement may be waived in writing by the City Manager, if no actual or potential conflict is involved.

(c) Consultant represents and warrants that it has not paid or agreed to pay any compensation, contingent or otherwise, direct or indirect, to solicit or procure this Agreement or any rights/benefits hereunder.

(d) Neither Consultant, nor any of Consultant's subcontractors performing any services on this Project, shall bid for, assist anyone in the preparation of a bid for, or perform any services pursuant to, any other contract in connection with this Project unless fully disclosed to and approved by the City Manager, in advance and in writing. Consultant and any of its subcontractors shall have no interest, direct or indirect, in any other contract with a third party in connection with this Project unless such interest is in accordance with all applicable law and fully disclosed to and approved by the City Manager, in advance and in writing. Notwithstanding any approval given by the City Manager under this provision, Consultant shall

**AGREEMENT FOR PLANNING ENTITLEMENT
AND PLAN CHECK SERVICES ON AN AS NEEDED BASIS**

remain responsible for complying with Section 25(a), above.

(e) If Consultant should subcontract all or any portion of the work to be performed or services to be provided under this Agreement, Consultant shall include the provisions of this Section 25 in each subcontract and require its subcontractors to comply therewith.

(f) This Section 25 shall survive expiration or termination of this Agreement.

26. All Plans, drawings, Specifications, reports, logs, and other documents prepared by the Consultant in its performance under this Agreement shall, upon completion of the project, be delivered to and be the property of the City, provided that the Consultant shall be entitled, at its own expense, to make copies thereof for its own use.

27. The laws of the State of California shall govern the rights, obligations, duties, and liabilities of the parties to this Agreement, and shall also govern the interpretation of this Agreement. Venue shall be vested in the Superior Court of the State of California, County of Riverside.

28. Supplementary General Provisions. (For projects that are funded by Federal programs). The following provisions, pursuant to 44 Code of Federal Regulations, Part 13, Subpart C, Section 13.36, as it may be amended from time to time, are included in the Agreement and are required to be included in all subcontracts entered into by CONTRACTOR for work pursuant to the Agreement, unless otherwise expressly provided herein. These provisions supersede any conflicting provisions in the General Conditions and shall take precedence over the General Conditions for purposes of interpretation of the General Conditions. These provisions do not otherwise modify or replace General Conditions not in direct conflict with these provisions. Definitions used in these provisions are as contained in the General Conditions.

**AGREEMENT FOR PLANNING ENTITLEMENT
AND PLAN CHECK SERVICES ON AN AS NEEDED BASIS**

- a) CONTRACTOR shall be subject to the administrative, contractual, and legal remedies provided in the General Conditions in the event CONTRACTOR violates or breaches terms of the Agreement.
- b) CITY may terminate the Agreement for cause or for convenience, and CONTRACTOR may terminate the Agreement, as provided the General Conditions.
- c) CONTRACTOR shall comply with Executive Order 11246 of September 24, 1965, entitled Equal Employment Opportunity, as amended by Executive Order 11375 of October 13, 1967, and as supplemented in Department of Labor regulations (41 CFR chapter 60). (All construction contracts awarded in excess of \$10,000 by CITY and/or subcontracts in excess of \$10,000 entered into by CONTRACTOR.)
- d) CONTRACTOR shall comply with the Copeland Anti-Kickback Act (18 U.S.C. 874) as supplemented in Department of Labor regulations (29 CFR Part 3) (All contracts and subcontracts for construction or repair.)
- e) CONTRACTOR shall comply with the Davis-Bacon Act (40 U.S.C. 276a to 276a7) as supplemented by Department of Labor regulations (29 CFR Part 5).
- f) CONTRACTOR shall comply with Sections 103 and 107 of the Contract Work Hours and Safety Standards Act (40 U.S.C. 327330) as supplemented by Department of Labor regulations (29 CFR Part 5).
- g) CONTRACTOR shall observe CITY requirements and regulations pertaining to reporting included in the General Conditions.
- h) Patent rights with respect to any discovery or invention which arises or is developed in the course of or under the Agreement shall be retained by the CITY.

**AGREEMENT FOR PLANNING ENTITLEMENT
AND PLAN CHECK SERVICES ON AN AS NEEDED BASIS**

- i) Copyrights and rights in data developed in the course of or under the Agreement shall be the property of the CITY. FEMA/CalOES reserve a royalty-free, nonexclusive, irrevocable license to reproduce, publish or otherwise use or authorize to others to use for federal purposes a copyright in any work developed under the Agreement and/or subcontracts for work pursuant to the Agreement.
- j) CONTRACTOR shall provide access by the City, the Federal grantor agency, the Comptroller General of the United States, or any of their duly authorized representatives to any books, documents, papers, and records of the contractor which are directly pertinent to that specific contract for the purpose of making audit, examination, excerpts, and transcriptions.
- k) CONTRACTOR shall retain all required records for three years after CITY makes final payments and all other pending matters relating to the Agreement are closed.
- l) CONTRACTOR shall comply with all applicable standards, orders, or requirements issued under section 306 of the Clean Air Act (42 U.S.C. 1857(h)), section 508 of the Clean Water Act (33 U.S.C. 1368), Executive Order 11738, and Environmental Protection Agency regulations (40 CFR part 15). (This provision applies to contracts exceeding \$100,000 and to subcontracts entered into pursuant to such contracts.)
- m) CONTRACTOR shall comply with mandatory standards and policies relating to energy efficiency which are contained in the State energy conservation plan issued in compliance with the Energy Policy and Conservation Act (Pub. L. 94163, 89 Stat. 871).

SIGNATURE PAGE FOLLOWS

IN WITNESS HEREOF, the parties have each caused their authorized representative to execute this Agreement.

City of Moreno Valley

Annealta Group

BY: _____
City Manager

BY: _____

Name: _____

TITLE: _____
(President or Vice President)

Date

Date

BY: _____

Name: _____

TITLE: _____
(Corporate Secretary)

Date

INTERNAL USE ONLY

APPROVED AS TO LEGAL FORM:

City Attorney

Date

RECOMMENDED FOR APPROVAL:

Department Head
(if contract exceeds 15,000)

Date

Attachment: Agreement for Project Related Services Annealta [Revision 1] (2886 : AUTHORIZATION TO AWARD PROJECT-RELATED

EXHIBIT A**SCOPE OF WORK**

At the direction and/or request of the City, Consultant agrees to perform work, including but not limited to:

- A. Plan review of architectural site plans, elevations, technical reports, environmental technical studies, landscape plans, subdivision maps and other documentation routinely associated with applications for land use entitlements. Application types will include, but not be limited to: General Plan Amendments; Changes of Zoning; Specific Plans; Conditional Use Permits; Plot Plans; Variances; and Temporary Use and Sign Permit/Programs. The applications would be the full array of land use types (e.g. residential, commercial, office, retail, industrial, business parks, mixed-use). The focus of the reviews will be to evaluate compliance with the City of Moreno Valley General Plan, all local ordinances, and state and federal laws pertaining to planning, zoning, and environmental quality.

For environmental review, it will be important to demonstrate the ability to complete preliminary environmental scoping of the project using the Initial Study Checklist, review of Initial Studies and technical studies, and experience in coordinating the environmental review process with outside agencies.

- B. Plan review of architectural site plans, elevations, technical reports, environmental technical studies, landscape plans, subdivision maps and other documentation routinely submitted to the Planning Division associated with applications for grading, site development and building permits. The plan check requirement will be from a planning and environmental perspective to ensure consistency with the City of Moreno Valley Municipal Zoning Code Development Regulations, Conditions of Approval tied to associated land use entitlement permits, and mitigation measures tied to the development project as part of the underlying California Environmental Quality Act (CEQA) document approved for the development project.
- C. Limited office space at City Hall will likely be available, but is not guaranteed, so the consultant firm must demonstrate ability to provide transportation of plans for the first reviews/check and for all subsequent re-reviews/checks between the City of Moreno Valley Planning Division office and the Consultant's office where the plan check services will be completed in a timely fashion when City Hall space is not available.
- D. **LAND USE ENTITLEMENTS:** The completion of plan review within the expected time frame. Standard first review is expected to be completed in a maximum of fifteen (15) working days from the date the City receives the plans for review. Subsequent reviews are expected to be completed within ten (10) working days from the date the City receives the plans for review. Upon written request from the City, Consultants will also provide expedited plan reviews. Expedited plan reviews will be expected to be completed in a maximum of five (5) working days from the date the City receives the plans for review. Subsequent expedited reviews are expected to be completed within four (4) working days from the date the City receives the plans for review.

There will be required meetings connected with the entitlement review for the project. The meetings include, but are not limited to, Project Review Staff Committee (PRSC) meetings with City Development Services staff which may also include the applicant. Attendance at other coordination meetings, including meetings with outside agencies may be required. For public hearings, attendance at the following public hearing(s) will be required as dictated by City Municipal Code requirements: Director's Hearing; Planning Commission; and City Council meetings.

For purposes of Bidder proposals, the Bidder should assume five (5) project meetings will be required for each entitlement project.

- E. Planning plan checks of grading, site development, landscaping, and building permits: The completion of plan checks within the expected time frame. Standard first review is expected to be completed in a maximum of ten (10) working days from the date the City receives the plans for review. Subsequent reviews are expected within seven (7) working days from the date the City receives the plans for review. Upon written request from the City, Consultants will also provide expedited Planning plan checks. Expedited plan checks will be expected to be provided in a maximum of five (5) working days from the date the City receives the plans. Subsequent expedited plan checks are expected within four (4) working days from the date the City receives the plans for review.
- F. The arrangement and/or attendance at required meetings connected with the plan review of a project.
- G. The submittal of two complete, typed listings of all required plan review/check corrections in the Planning Division's format, which will be provided to the Consultant.
- H. The Consultant shall indicate if they provide electronic plan check services. If requested by the City, Consultant shall provide additional documentation of these services, including sample documents generated by the system and a live demonstration of the service for evaluation by the City.
- I. Inspections of residential, commercial, and industrial sites to ensure Planning Division project interests are met through conformance with the approved plans, documents (e.g. agreements, standard plans, technical details), conditions of approval, and applicable mitigation measures prior to issuance of a Building Final and/or certificate of occupancy.
- J. Maintain all records related to the plan review(s) and/or plan check review(s) in accordance with established Department file management practice. The Consultant will be responsible for maintaining case files, electronic files, and updates to the City's "Simplicity" case tracking system. The case tracking system is currently used for the completion of project comments and project conditions of approval for plan reviews, and the capabilities are expanding. Experience working with the Accela Civic Platform is desirable.

EXHIBIT B**CITY - SERVICES TO BE PROVIDED
TO CONSULTANT**

1. Furnish the Consultant all in-house data which is pertinent to services to be performed by the Consultant and which is within the custody or control of the City, including, but not limited to, copies of record and off-record maps and other record and off-record property data, right-of-way maps and other right-of-way data, pending or proposed subject property land division and development application data, all newly developed and pertinent design and project specification data, and such other pertinent data which may become available to the City.
2. Provide timely review, processing, and reasonably expeditious approval of all submittals by the Consultant.
3. Provide timely City staff liaison with the Consultant when requested and when reasonably needed.

EXHIBIT C

TERMS OF PAYMENT

1. The Consultant's compensation shall not exceed \$375,000.00.
2. Invoices will need to be considerate of the Fee Refund policy outlined in Section 9.01.150 of the Municipal Code (<http://qcode.us/codes/morenovalley/>). There are two project application types: 1) For projects that will ultimately require a public hearing, the invoices would track the progress on the project. The first invoice would be a maximum of 20% of the proposed consultant fee. The second invoice would be for up to an additional 40% (cumulative 60%) of the proposed consultant fee. The third invoice would be for an additional 10% (cumulative 70%) of the proposed consultant fee. The fourth would be for an additional 20% (cumulative 90%) of the proposed consultant fee. And then a final 10% (cumulative 100%) of the proposed consultant fee would be paid when the project is complete. Note that these invoices may not necessarily come in on a monthly basis since they are tied to actual progress on the project. 2) For projects that do not a public hearing the invoices would also track the progress on the project but only require 2 payments. The first invoice would be a maximum of 50% of the proposed consultant fee. The second invoice would be for the balance 50% (cumulative 100%) of the proposed consultant fee, paid after the project is complete. Note that these invoices may not necessarily come in on a monthly basis since they are tied to actual progress on the project. As the vendor is required to submit a monthly invoice for the types of project listed above, the invoice should properly track each assignment and would simply state "No payment due for this project this month" when that is the case. When the payable activity occurs that particularly monthly invoice would reflect that activity accordingly.

3. The Consultant will obtain, and keep current during the term of this Agreement, the required City of Moreno Valley business license. Proof of a current City of Moreno Valley business license will be required prior to any payments by the City. Any invoice not paid because the proof of a current City of Moreno Valley business license has not been provided will not incur any fees, late charges, or other penalties. Complete instructions for obtaining a City of Moreno Valley business license are located at: http://www.moval.org/city_hall/departments/fin-man-serv/b-license.shtml
3. The Consultant will electronically submit an invoice to the City once a month for progress payments along with documentation evidencing services completed to date. The progress payment is based on actual time and materials expended in furnishing authorized professional services during the preceding calendar month. At no time will the City pay for more services than have been satisfactorily completed and the City Engineer's determination of the amount due for any progress payment shall be final. The consultant will submit all original invoices to Accounts Payable staff at AccountsPayable@moval.org
Accounts Payable questions can be directed to (951) 413-3073.
Copies of invoices may be submitted to the Planning Division at planning@moval.org or calls directed to (951) 413-3206.
4. The Consultant agrees that City payments will be received via Automated Clearing House (ACH) Direct Deposit and that the required ACH Authorization form will be completed prior to any payments by the City. Any invoice not paid because the completed ACH Authorization Form has not been provided will not incur any fees, late charges, or other penalties. The ACH Authorization Form is located at:

http://www.moval.org/city_hall/forms.shtml#bf

5. The minimum information required on all invoices is:
 - A. Vendor Name, Mailing Address, and Phone Number
 - B. Invoice Date
 - C. Vendor Invoice Number
 - D. City-provided Reference Number (e.g. Project, Activity)
 - E. Detailed work hours by class title (e.g. Manager, Technician, or Specialist), services performed and rates, explicit portion of a contract amount, or detailed billing information that is sufficient to justify the invoice amount; single, lump amounts without detail are not acceptable.

6. The City shall pay the Consultant for all invoiced, authorized professional services within thirty (30) days of receipt of the invoice for same.

EXHIBIT D**INSURANCE REQUIREMENTS****Minimum Scope of Insurance**

Coverage shall be at least as broad as:

1. The most current version of Insurance Services Office (ISO) Commercial General Liability Coverage Form CG 00 01, which shall include insurance for “bodily injury,” “property damage” and “personal and advertising injury” with coverage for premises and operations, products and completed operations, and contractual liability.
2. The most current version of Insurance Service Office (ISO) Business Auto Coverage Form CA 00 01, which shall include coverage for all owned, hired, and non-owned automobiles or other licensed vehicles (Code 1- Any Auto).
3. Workers’ Compensation insurance as required by the California Labor Code and Employer’s Liability Insurance.
4. Professional Liability (Errors and Omissions) insurance appropriate to Consultant’s profession.

Minimum Limits of Insurance

Consultant shall maintain limits of liability of not less than:

1. General Liability:
 - \$1,000,000 per occurrence for bodily injury and property damage
 - \$1,000,000 per occurrence for personal and advertising injury
 - \$2,000,000 aggregate for products and completed operations
 - \$2,000,000 general aggregate
2. Automobile Liability:
 - \$1,000,000 per accident for bodily injury and property damage
3. Employer’s Liability:
 - \$1,000,000 each accident for bodily injury
 - \$1,000,000 disease each employee
 - \$1,000,000 disease policy limit

4. Professional Liability (Errors and Omissions):

\$1,000,000 per claim/occurrence
\$2,000,000 policy aggregate

Umbrella or Excess Insurance

In the event Consultant purchases an Umbrella or Excess insurance policy(ies) to meet the "Minimum Limits of Insurance," this insurance policy(ies) shall "follow form" and afford no less coverage than the primary insurance policy(ies).

Deductibles and Self-Insured Retentions

Consultant shall be responsible for payment of any deductibles contained in any insurance policy(ies) required hereunder and Consultant shall also be responsible for payment of any self-insured retentions. Any deductibles or self-insured retentions must be declared to, and approved by, the City Manager or his/her designee. At the option of the City Manager or his/her designee, either (i) the insurer shall reduce or eliminate such deductibles or self-insured retentions as respects City, CSD, Housing Authority and each of their officers, officials, employees, agents and volunteers; or (ii) Consultant shall provide a financial guarantee, satisfactory to the City Manager or his/her designee, guaranteeing payment of losses and related investigations, claim administration and defense expenses. At no time shall City be responsible for the payment of any deductibles or self-insured retentions.

Other Insurance Provisions

The General Liability and Automobile Liability insurance policies are to contain, or be endorsed to contain, the following provisions:

1. City, CSD, Housing Authority and each of their officers, officials, employees, agents and volunteers are to be covered as additional insureds.
2. The coverage shall contain no special limitations on the scope of protection afforded to City, CSD, Housing Authority and each of their officers, officials, employees, agents and volunteers.
3. Consultant's insurance coverage shall be primary and no contribution shall be required of City.

The Workers' Compensation insurance policy is to contain, or be endorsed to contain, the following provision: Consultant and its insurer shall waive any right of subrogation against City, CSD, Housing Authority and each of their officers, officials, employees, agents and volunteers.

If the Professional Liability (Errors and Omissions) insurance policy is written on a claims-made form:

1. The retroactive date must be shown, and must be before the effective date of the Agreement or the commencement of work by Consultant.
2. Insurance must be maintained and evidence of insurance must be provided for at least 3 years after any expiration or termination of the Agreement or, in the alternative, the policy shall be endorsed to provide not less than a 3-year discovery period.
3. If coverage is canceled or non-renewed, and not replaced with another claims-made policy form with a retroactive date prior to the effective date of the Agreement or the commencement of work by Consultant, Consultant must purchase extended reporting coverage for a minimum of 3 years following the expiration or termination of the Agreement.
4. A copy of the claims reporting requirements must be submitted to City for review.
5. These requirements shall survive expiration or termination of the Agreement.

All policies of insurance required hereunder shall be endorsed to provide that the coverage shall not be cancelled, non-renewed, reduced in coverage or in limits except after 30 calendar day written notice by certified mail, return receipt requested, has been given to City. Upon issuance by the insurer, broker, or agent of a notice of cancellation, non-renewal, or reduction in coverage or in limits, Consultant shall furnish City with a new certificate and applicable endorsements for such policy(ies). In the event any policy is due to expire during the work to be performed for City, Consultant shall provide a new certificate, and applicable endorsements, evidencing renewal of such policy not less than 15 calendar days prior to the expiration date of the expiring policy.

Acceptability of Insurers

All policies of insurance required hereunder shall be placed with an insurance company(ies) admitted by the California Insurance Commissioner to do business in the State of California and rated not less than "A-VII" in Best's Insurance Rating Guide; or authorized by the City Manager or his/her designee.

Verification of Coverage

Consultant shall furnish City with all certificate(s) and **applicable endorsements** effecting coverage required hereunder. All certificates and **applicable endorsements** are to be received and approved by the City Manager or his/her designee prior to City's execution of the Agreement and before work commences.

**AGREEMENT FOR PLANNING ENTITLEMENT AND PLAN CHECK SERVICES
ON AN AS NEEDED BASIS**

This Agreement is by and between the City of Moreno Valley, California, a municipal corporation, hereinafter described as "City," and Civic Solutions, a California corporation, hereinafter described as "Consultant." This Agreement is made and entered into effective on the date the City signs this Agreement.

RECITALS

WHEREAS, the City has determined it is in the public interest to proceed with the professional work hereinafter described as "Project"; and

WHEREAS, the City has determined the Project involves the performance of professional and technical services of a temporary nature as more specifically described in Exhibit "A" (Scope of Work); and

WHEREAS, the City does not have available employees to perform the services for the Project; and

WHEREAS, the City has requested the Consultant to perform such services for the Project; and

WHEREAS, the Consultant is professionally qualified in California to perform the professional and technical services required for the Project, and hereby represents that it desires to and is professionally and legally capable of performing the services called for by this Agreement;

THEREFORE, the City and the Consultant, for the consideration hereinafter described, mutually agree as follows:

**AGREEMENT FOR PLANNING ENTITLEMENT
AND PLAN CHECK SERVICES ON AN AS NEEDED BASIS**

DESCRIPTION OF PROJECT

1. The Project is described as Planning Entitlement and Plan Check Services on an As-Needed Basis.

SCOPE OF SERVICES

2. The Consultant's scope of service is described on Exhibit "A" attached hereto and incorporated herein by this reference.

3. The City's responsibility is described on Exhibit "B" attached hereto and incorporated herein by this reference.

PAYMENT TERMS

4. The City agrees to pay the Consultant and the Consultant agrees to receive a "Not-to-Exceed" fee of \$375,000 (\$75,000 for the first year, and \$75,000 annually for each fiscal year for a period not to exceed four (4) additional years) in accordance with the payment terms provided on Exhibit "C" attached hereto and incorporated herein by this reference.

TIME FOR PERFORMANCE

5. The Consultant shall commence services upon receipt of written direction to proceed from the City.

6. The Consultant shall perform the work described on Exhibit "A" in accordance with the schedule set forth in Exhibit "A" attached hereto and incorporated by this reference.

7. This Agreement shall be effective from effective date and shall continue in full force and effect date through **June 30, 2018**, subject to any earlier termination in accordance with this Agreement.

(a) This Agreement shall be automatically renewed annually at the end of each fiscal year for a period not to exceed four (4) additional years, provided that funding appropriations and program approvals have been granted by the City Council and if no written

**AGREEMENT FOR PLANNING ENTITLEMENT
AND PLAN CHECK SERVICES ON AN AS NEEDED BASIS**

notice of termination is received by either party. This Agreement shall be renewed on the same condition until a new Agreement is fully executed or until terminated as provided for in this Agreement.

(b) The services of Consultant shall be completed in a sequence assuring expeditious completion, but in any event, all such services shall be completed prior to expiration of this Agreement.

8. (a) The Consultant agrees that the personnel, including the principal Project manager, and all subconsultants assigned to the Project by the Consultant, shall be subject to the prior approval of the City.

(b) No change in subconsultants or key personnel shall be made by the Consultant without written prior approval of the City.

SPECIAL PROVISIONS

9. It is understood and agreed that the Consultant is, and at all times shall be, an independent contractor and nothing contained herein shall be construed as making the Consultant or any individual whose compensation for services is paid by the Consultant, an agent or employee of the City, or authorizing the Consultant to create or assume any obligation or liability for or on behalf of the City.

10. The Consultant may also retain or subcontract for the services of other necessary consultants with the prior written approval of the City. Payment for such services shall be the responsibility of the Consultant. Any and all subconsultants employed by the Consultant shall be subject to the terms and conditions of this Agreement, except that the City shall have no obligation to pay any subconsultant for services rendered on the Project.

11. The Consultant and the City agree to use reasonable care and diligence to perform their respective services under this Agreement.

**AGREEMENT FOR PLANNING ENTITLEMENT
AND PLAN CHECK SERVICES ON AN AS NEEDED BASIS**

12. The Consultant shall comply with applicable federal, state, and local laws in the performance of work under this Agreement.

13. To the extent required by controlling federal, state and local law, Consultant shall not employ discriminatory practices in the provision of services, employment of personnel, or in any other respect on the basis of race, religious creed, color, national origin, ancestry, physical disability, mental disability, medical condition, marital status, sex, age, sexual orientation, ethnicity, status as a disabled veteran or veteran of the Vietnam era. Subject to the foregoing and during the performance of this Agreement, Consultant agrees as follows:

(a) Consultant will comply with all applicable laws and regulations providing that no person shall, on the grounds of race, religious creed, color, national origin, ancestry, physical disability, mental disability, medical condition, marital status, sex, age, sexual orientation, ethnicity, status as a disabled veteran or veteran of the Vietnam era be excluded from participation in, be denied the benefits of, or be subject to discrimination under any program or activity made possible by or resulting from this Agreement.

(b) Consultant will not discriminate against any employee or applicant for employment because of race, religious creed, color, national origin, ancestry, physical disability, mental disability, medical condition, marital status, sex, age, sexual orientation, ethnicity, status as a disabled veteran or veteran of the Vietnam era. Consultant shall ensure that applicants are employed, and the employees are treated during employment, without regard to their race, religious creed, color, national origin, ancestry, physical disability, mental disability, medical condition, marital status, sex, age, sexual orientation, ethnicity, status as a disabled veteran or veteran of the Vietnam era. Such requirement shall apply to Consultant's employment practices including, but not be limited to, the following: employment, upgrading, demotion or transfer; recruitment or recruitment advertising; layoff or termination; rates of pay

**AGREEMENT FOR PLANNING ENTITLEMENT
AND PLAN CHECK SERVICES ON AN AS NEEDED BASIS**

or other forms of compensation; and selection for training, including apprenticeship. Consultant agrees to post in conspicuous places, available to employees and applicants for employment, notices setting forth the provision of this nondiscrimination clause.

(c) Consultant will, in all solicitations or advertisements for employees placed by or on behalf of Consultant in pursuit hereof, state that all qualified applicants will receive consideration for employment without regard to race, religious creed, color, national origin, ancestry, physical disability, mental disability, medical condition, marital status, sex, age, sexual orientation, ethnicity, status as a disabled veteran or veteran of the Vietnam era.

(d) If Consultant should subcontract all or any portion of the services to be performed under this Agreement, Consultant shall cause each subcontractor to also comply with the requirements of this Section 13.

14. To the furthest extent allowed by law (including California Civil Code section 2782.8 if applicable), Consultant shall indemnify, hold harmless and defend the City, the Moreno Valley Community Services District (“CSD”), the Moreno Valley Housing Authority (“Housing Authority”) and each of their officers, officials, employees, agents and volunteers from any and all loss, liability, fines, penalties, forfeitures, costs and damages (whether in contract, tort or strict liability, including but not limited to personal injury, death at any time and property damage), and from any and all claims, demands and actions in law or equity (including reasonable attorney's fees and litigation expenses) that arise out of, pertain to, or relate to the negligence, recklessness or willful misconduct of Consultant, its principals, officers, employees, agents or volunteers in the performance of this Agreement.

If Consultant should subcontract all or any portion of the services to be performed under this Agreement, Consultant shall require each subcontractor to indemnify, hold harmless and defend City, CSD, Housing Authority and each of their officers, officials, employees, agents

**AGREEMENT FOR PLANNING ENTITLEMENT
AND PLAN CHECK SERVICES ON AN AS NEEDED BASIS**

and volunteers in accordance with the terms of the preceding paragraph.

This section shall survive termination or expiration of this Agreement.

15. Insurance.

(a) Throughout the life of this Agreement, Consultant shall pay for and maintain in full force and effect all insurance as required in **Exhibit D** or as may be authorized in writing by the City Manager or his/her designee at any time and in his/her sole discretion.

(b) If at any time during the life of the Agreement or any extension, Consultant or any of its subcontractors fail to maintain any required insurance in full force and effect, all services and work under this Agreement shall be discontinued immediately, and all payments due or that become due to Consultant shall be withheld until notice is received by City that the required insurance has been restored to full force and effect and that the premiums therefore have been paid for a period satisfactory to City. Any failure to maintain the required insurance shall be sufficient cause for City to terminate this Agreement. No action taken by City pursuant to this section shall in any way relieve Consultant of its responsibilities under this Agreement. The phrase "fail to maintain any required insurance" shall include, without limitation, notification received by City that an insurer has commenced proceedings, or has had proceedings commenced against it, indicating that the insurer is insolvent.

(c) The fact that insurance is obtained by Consultant shall not be deemed to release or diminish the liability of Consultant, including, without limitation, liability under the indemnity provisions of this Agreement. The duty to indemnify City shall apply to all claims and liability regardless of whether any insurance policies are applicable. The policy limits do not act as a limitation upon the amount of indemnification to be provided by Consultant. Approval or purchase of any insurance contracts or policies shall in no way relieve from liability nor limit the liability of Consultant, its principals, officers, agents, employees, persons under the

**AGREEMENT FOR PLANNING ENTITLEMENT
AND PLAN CHECK SERVICES ON AN AS NEEDED BASIS**

supervision of Consultant, vendors, suppliers, invitees, consultants, sub-consultants, subcontractors, or anyone employed directly or indirectly by any of them.

(d) Upon request of City, Consultant shall immediately furnish City with a complete copy of any insurance policy required under this Agreement, including all endorsements, with said copy certified by the underwriter to be a true and correct copy of the original policy. This requirement shall survive expiration or termination of this Agreement.

(e) If Consultant should subcontract all or any portion of the services to be performed under this Agreement, Consultant shall require each subcontractor to provide insurance protection in favor of City and each of its officers, officials, employees, agents and volunteers in accordance with the terms of this section, except that any required certificates and applicable endorsements shall be on file with Consultant and City prior to the commencement of any services by the subcontractor.

16. The waiver by either party of a breach by the other of any provision of this Agreement shall not constitute a continuing waiver or a waiver of any subsequent breach of either the same or a different provision of this Agreement. No provisions of this Agreement may be waived unless in writing and signed by all parties to this Agreement. Waiver of any one provision herein shall not be deemed to be a waiver of any other provision herein.

17. Consultant and subconsultants shall pay prevailing wage rates when required by the Labor Laws of the State of California.

18. (a) The Consultant shall deliver to the Planning Official or his designee, fully completed and detailed project-related documents which shall become the property of the City. The Consultant may retain, for its files, copies of any and all material, including drawings, documents, and specifications, produced by the Consultant in performance of this Agreement.

(b) The Consultant shall be entitled to copies of all furnished materials for his

**AGREEMENT FOR PLANNING ENTITLEMENT
AND PLAN CHECK SERVICES ON AN AS NEEDED BASIS**

files and his subconsultants, if any.

(c) The City agrees to hold the Consultant free and harmless from any claim arising from any unauthorized use of computations, maps, and other documents prepared or provided by the Consultant under this Agreement, if used by the City on other work without the permission of the Consultant. Consultant acknowledges that Consultant work product produced under this agreement may be public record under State law.

19. (a) This Agreement shall terminate without any liability of City to Consultant upon the earlier of: (i) Consultant's filing for protection under the federal bankruptcy laws, or any bankruptcy petition or petition for receiver commenced by a third party against Consultant; (ii) 10 calendar days prior written notice with or without cause by City to Consultant; (iii) City's non-appropriation of funds sufficient to meet its obligations hereunder during any City fiscal year of this Agreement, or insufficient funding for the Project; or (iv) expiration of this Agreement. The written notice shall specify the date of termination. Upon receipt of such notice, the Consultant may continue services on the project through the date of termination, provided that no service(s) shall be commenced or continued after receipt of the notice, which is not intended to protect the interest of the City. The City shall pay the Consultant within thirty (30) days after the date of termination for all non-objected to services performed by the Consultant in accordance herewith through the date of termination. Consultant shall not be paid for any work or services performed or costs incurred which reasonably could have been avoided.

(b) In the event of termination due to failure of Consultant to satisfactorily perform in accordance with the terms of this Agreement, City may withhold an amount that would otherwise be payable as an offset to, but not in excess of, City's damages caused by such failure. In no event shall any payment by City pursuant to this Agreement constitute a waiver

**AGREEMENT FOR PLANNING ENTITLEMENT
AND PLAN CHECK SERVICES ON AN AS NEEDED BASIS**

by City of any breach of this Agreement which may then exist on the part of Consultant, nor shall such payment impair or prejudice any remedy available to City with respect to the breach.

(c) Upon any breach of this Agreement by Consultant, City may (i) exercise any right, remedy (in contract, law or equity), or privilege which may be available to it under applicable laws of the State of California or any other applicable law; (ii) proceed by appropriate court action to enforce the terms of the Agreement; and/or (iii) recover all direct, indirect, consequential, economic and incidental damages for the breach of the Agreement. If it is determined that City improperly terminated this Agreement for default, such termination shall be deemed a termination for convenience.

(d) Consultant shall be liable for default unless nonperformance is caused by an occurrence beyond the reasonable control of Consultant and without its fault or negligence such as, acts of God or the public enemy, acts of City in its contractual capacity, fires, floods, epidemics, quarantine restrictions, strikes, unusually severe weather, and delays of common carriers. Consultant shall notify City in writing as soon as it is reasonably possible after the commencement of any excusable delay, setting forth the full particulars in connection therewith, and shall remedy such occurrence with all reasonable dispatch, and shall promptly give written notice to Administrator of the cessation of such occurrence.

20. This Agreement is binding upon the City and the Consultant and their successors and assigns. Except as otherwise provided herein, neither the City nor the Consultant shall assign, sublet, or transfer its interest in this Agreement or any part thereof without the prior written consent of the other.

21. A City representative shall be designated by the City and a Consultant representative shall be designated by the Consultant. The City representative and the Consultant representative shall be the primary contact person for each party regarding

**AGREEMENT FOR PLANNING ENTITLEMENT
AND PLAN CHECK SERVICES ON AN AS NEEDED BASIS**

performance of this Agreement. The City representative shall cooperate with the Consultant, and the Consultant's representative shall cooperate with the City in all matters regarding this Agreement and in such a manner as will result in the performance of the services in a timely and expeditious fashion.

22. This Agreement represents the entire and integrated Agreement between the City and the Consultant, and supersedes all prior negotiations, representations or Agreements, either written or oral. This Agreement may be modified or amended only by a subsequent written Agreement signed by both parties.

23. Where the payment terms provide for compensation on a time and materials basis, the Consultant shall maintain adequate records to permit inspection and audit of the Consultant's time and materials charges under this Agreement. The Consultant shall make such records available to the City at the Consultant's office during normal business hours upon reasonable notice. Nothing herein shall convert such records into public records. Except as may be otherwise required by law, such records will be available only to the City. Such records shall be maintained by the Consultant for three (3) years following completion of the services under this Agreement.

24. The City and the Consultant agree, that to the extent permitted by law, until final approval by the City, all data shall be treated as confidential and will not be released to third parties without the prior written consent of both parties.

25. (a) Consultant shall comply, and require its subcontractors to comply, with all applicable (i) professional canons and requirements governing avoidance of impermissible client conflicts; and (ii) federal, state and local conflict of interest laws and regulations including, without limitation, California Government Code Section 1090 et. seq., the California Political Reform Act (California Government Code Section 87100 et. seq.) and the regulations

**AGREEMENT FOR PLANNING ENTITLEMENT
AND PLAN CHECK SERVICES ON AN AS NEEDED BASIS**

of the Fair Political Practices Commission concerning disclosure and disqualification (2 California Code of Regulations Section 18700 et. seq.). At any time, upon written request of City, Consultant shall provide a written opinion of its legal counsel and that of any subcontractor that, after a due diligent inquiry, Consultant and the respective subcontractor(s) are in full compliance with all laws and regulations. Consultant shall take, and require its subcontractors to take, reasonable steps to avoid any appearance of a conflict of interest. Upon discovery of any facts giving rise to the appearance of a conflict of interest, Consultant shall immediately notify City of these facts in writing.

(b) In performing the work or services to be provided hereunder, Consultant shall not employ or retain the services of any person while such person either is employed by City or is a member of any City council, commission, board, committee, or similar City body. This requirement may be waived in writing by the City Manager, if no actual or potential conflict is involved.

(c) Consultant represents and warrants that it has not paid or agreed to pay any compensation, contingent or otherwise, direct or indirect, to solicit or procure this Agreement or any rights/benefits hereunder.

(d) Neither Consultant, nor any of Consultant's subcontractors performing any services on this Project, shall bid for, assist anyone in the preparation of a bid for, or perform any services pursuant to, any other contract in connection with this Project unless fully disclosed to and approved by the City Manager, in advance and in writing. Consultant and any of its subcontractors shall have no interest, direct or indirect, in any other contract with a third party in connection with this Project unless such interest is in accordance with all applicable law and fully disclosed to and approved by the City Manager, in advance and in writing. Notwithstanding any approval given by the City Manager under this provision, Consultant shall

AGREEMENT FOR PLANNING ENTITLEMENT AND PLAN CHECK SERVICES ON AN AS NEEDED BASIS

remain responsible for complying with Section 25(a), above.

(e) If Consultant should subcontract all or any portion of the work to be performed or services to be provided under this Agreement, Consultant shall include the provisions of this Section 25 in each subcontract and require its subcontractors to comply therewith.

(f) This Section 25 shall survive expiration or termination of this Agreement.

26. All Plans, drawings, Specifications, reports, logs, and other documents prepared by the Consultant in its performance under this Agreement shall, upon completion of the project, be delivered to and be the property of the City, provided that the Consultant shall be entitled, at its own expense, to make copies thereof for its own use.

27. The laws of the State of California shall govern the rights, obligations, duties, and liabilities of the parties to this Agreement, and shall also govern the interpretation of this Agreement. Venue shall be vested in the Superior Court of the State of California, County of Riverside.

28. Supplementary General Provisions. (For projects that are funded by Federal programs). The following provisions, pursuant to 44 Code of Federal Regulations, Part 13, Subpart C, Section 13.36, as it may be amended from time to time, are included in the Agreement and are required to be included in all subcontracts entered into by CONTRACTOR for work pursuant to the Agreement, unless otherwise expressly provided herein. These provisions supersede any conflicting provisions in the General Conditions and shall take precedence over the General Conditions for purposes of interpretation of the General Conditions. These provisions do not otherwise modify or replace General Conditions not in direct conflict with these provisions. Definitions used in these provisions are as contained in the General Conditions.

**AGREEMENT FOR PLANNING ENTITLEMENT
AND PLAN CHECK SERVICES ON AN AS NEEDED BASIS**

- a) CONTRACTOR shall be subject to the administrative, contractual, and legal remedies provided in the General Conditions in the event CONTRACTOR violates or breaches terms of the Agreement.
- b) CITY may terminate the Agreement for cause or for convenience, and CONTRACTOR may terminate the Agreement, as provided the General Conditions.
- c) CONTRACTOR shall comply with Executive Order 11246 of September 24, 1965, entitled Equal Employment Opportunity, as amended by Executive Order 11375 of October 13, 1967, and as supplemented in Department of Labor regulations (41 CFR chapter 60). (All construction contracts awarded in excess of \$10,000 by CITY and/or subcontracts in excess of \$10,000 entered into by CONTRACTOR.)
- d) CONTRACTOR shall comply with the Copeland Anti-Kickback Act (18 U.S.C. 874) as supplemented in Department of Labor regulations (29 CFR Part 3) (All contracts and subcontracts for construction or repair.)
- e) CONTRACTOR shall comply with the Davis-Bacon Act (40 U.S.C. 276a to 276a7) as supplemented by Department of Labor regulations (29 CFR Part 5).
- f) CONTRACTOR shall comply with Sections 103 and 107 of the Contract Work Hours and Safety Standards Act (40 U.S.C. 327330) as supplemented by Department of Labor regulations (29 CFR Part 5).
- g) CONTRACTOR shall observe CITY requirements and regulations pertaining to reporting included in the General Conditions.
- h) Patent rights with respect to any discovery or invention which arises or is developed in the course of or under the Agreement shall be retained by the CITY.

**AGREEMENT FOR PLANNING ENTITLEMENT
AND PLAN CHECK SERVICES ON AN AS NEEDED BASIS**

- i) Copyrights and rights in data developed in the course of or under the Agreement shall be the property of the CITY. FEMA/CalOES reserve a royalty-free, nonexclusive, irrevocable license to reproduce, publish or otherwise use or authorize to others to use for federal purposes a copyright in any work developed under the Agreement and/or subcontracts for work pursuant to the Agreement.
- j) CONTRACTOR shall provide access by the City, the Federal grantor agency, the Comptroller General of the United States, or any of their duly authorized representatives to any books, documents, papers, and records of the contractor which are directly pertinent to that specific contract for the purpose of making audit, examination, excerpts, and transcriptions.
- k) CONTRACTOR shall retain all required records for three years after CITY makes final payments and all other pending matters relating to the Agreement are closed.
- l) CONTRACTOR shall comply with all applicable standards, orders, or requirements issued under section 306 of the Clean Air Act (42 U.S.C. 1857(h)), section 508 of the Clean Water Act (33 U.S.C. 1368), Executive Order 11738, and Environmental Protection Agency regulations (40 CFR part 15). (This provision applies to contracts exceeding \$100,000 and to subcontracts entered into pursuant to such contracts.)
- m) CONTRACTOR shall comply with mandatory standards and policies relating to energy efficiency which are contained in the State energy conservation plan issued in compliance with the Energy Policy and Conservation Act (Pub. L. 94163, 89 Stat. 871).

SIGNATURE PAGE FOLLOWS

IN WITNESS HEREOF, the parties have each caused their authorized representative to execute this Agreement.

City of Moreno Valley

Civic Solutions, Inc.

BY: _____
City Manager

BY: _____

Name: _____

TITLE: _____
(President or Vice President)

Date

Date

BY: _____

Name: _____

TITLE: _____
(Corporate Secretary)

Date

INTERNAL USE ONLY

APPROVED AS TO LEGAL FORM:

City Attorney

Date

RECOMMENDED FOR APPROVAL:

Department Head
(if contract exceeds 15,000)

Date

Attachment: Agreement for Project Related Services Civic Solutions [Revision 1] (2886 : AUTHORIZATION TO AWARD PROJECT-RELATED

EXHIBIT A**SCOPE OF WORK**

At the direction and/or request of the City, Consultant agrees to perform work, including but not limited to:

- A. Plan review of architectural site plans, elevations, technical reports, environmental technical studies, landscape plans, subdivision maps and other documentation routinely associated with applications for land use entitlements. Application types will include, but not be limited to: General Plan Amendments; Changes of Zoning; Specific Plans; Conditional Use Permits; Plot Plans; Variances; and Temporary Use and Sign Permit/Programs. The applications would be the full array of land use types (e.g. residential, commercial, office, retail, industrial, business parks, mixed-use). The focus of the reviews will be to evaluate compliance with the City of Moreno Valley General Plan, all local ordinances, and state and federal laws pertaining to planning, zoning, and environmental quality.

For environmental review, it will be important to demonstrate the ability to complete preliminary environmental scoping of the project using the Initial Study Checklist, review of Initial Studies and technical studies, and experience in coordinating the environmental review process with outside agencies.

- B. Plan review of architectural site plans, elevations, technical reports, environmental technical studies, landscape plans, subdivision maps and other documentation routinely submitted to the Planning Division associated with applications for grading, site development and building permits. The plan check requirement will be from a planning and environmental perspective to ensure consistency with the City of Moreno Valley Municipal Zoning Code Development Regulations, Conditions of Approval tied to associated land use entitlement permits, and mitigation measures tied to the development project as part of the underlying California Environmental Quality Act (CEQA) document approved for the development project.
- C. Limited office space at City Hall will likely be available, but is not guaranteed, so the consultant firm must demonstrate ability to provide transportation of plans for the first reviews/check and for all subsequent re-reviews/checks between the City of Moreno Valley Planning Division office and the Consultant's office where the plan check services will be completed in a timely fashion when City Hall space is not available.
- D. **LAND USE ENTITLEMENTS:** The completion of plan review within the expected time frame. Standard first review is expected to be completed in a maximum of fifteen (15) working days from the date the City receives the plans for review. Subsequent reviews are expected to be completed within ten (10) working days from the date the City receives the plans for review. Upon written request from the City, Consultants will also provide expedited plan reviews. Expedited plan reviews will be expected to be completed in a maximum of five (5) working days from the date the City receives the plans for review. Subsequent expedited reviews are expected to be completed within four (4) working days from the date the City receives the plans for review.

There will be required meetings connected with the entitlement review for the project. The meetings include, but are not limited to, Project Review Staff Committee (PRSC) meetings with City Development Services staff which may also include the applicant. Attendance at other coordination meetings, including meetings with outside agencies may be required. For public hearings, attendance at the following public hearing(s) will be required as dictated by City Municipal Code requirements: Director's Hearing; Planning Commission; and City Council meetings.

For purposes of Bidder proposals, the Bidder should assume five (5) project meetings will be required for each entitlement project.

- E. Planning plan checks of grading, site development, landscaping, and building permits: The completion of plan checks within the expected time frame. Standard first review is expected to be completed in a maximum of ten (10) working days from the date the City receives the plans for review. Subsequent reviews are expected within seven (7) working days from the date the City receives the plans for review. Upon written request from the City, Consultants will also provide expedited Planning plan checks. Expedited plan checks will be expected to be provided in a maximum of five (5) working days from the date the City receives the plans. Subsequent expedited plan checks are expected within four (4) working days from the date the City receives the plans for review.
- F. The arrangement and/or attendance at required meetings connected with the plan review of a project.
- G. The submittal of two complete, typed listings of all required plan review/check corrections in the Planning Division's format, which will be provided to the Consultant.
- H. The Consultant shall indicate if they provide electronic plan check services. If requested by the City, Consultant shall provide additional documentation of these services, including sample documents generated by the system and a live demonstration of the service for evaluation by the City.
- I. Inspections of residential, commercial, and industrial sites to ensure Planning Division project interests are met through conformance with the approved plans, documents (e.g. agreements, standard plans, technical details), conditions of approval, and applicable mitigation measures prior to issuance of a Building Final and/or certificate of occupancy.
- J. Maintain all records related to the plan review(s) and/or plan check review(s) in accordance with established Department file management practice. The Consultant will be responsible for maintaining case files, electronic files, and updates to the City's "Simplicity" case tracking system. The case tracking system is currently used for the completion of project comments and project conditions of approval for plan reviews, and the capabilities are expanding. Experience working with the Accela Civic Platform is desirable.

EXHIBIT BCITY - SERVICES TO BE PROVIDED
TO CONSULTANT

1. Furnish the Consultant all in-house data which is pertinent to services to be performed by the Consultant and which is within the custody or control of the City, including, but not limited to, copies of record and off-record maps and other record and off-record property data, right-of-way maps and other right-of-way data, pending or proposed subject property land division and development application data, all newly developed and pertinent design and project specification data, and such other pertinent data which may become available to the City.
2. Provide timely review, processing, and reasonably expeditious approval of all submittals by the Consultant.
3. Provide timely City staff liaison with the Consultant when requested and when reasonably needed.

EXHIBIT C

TERMS OF PAYMENT

1. The Consultant's compensation shall not exceed \$375,000.00.
2. Invoices will need to be considerate of the Fee Refund policy outlined in Section 9.01.150 of the Municipal Code (<http://qcode.us/codes/morenovalley/>). There are two project application types: 1) For projects that will ultimately require a public hearing, the invoices would track the progress on the project. The first invoice would be a maximum of 20% of the proposed consultant fee. The second invoice would be for up to an additional 40% (cumulative 60%) of the proposed consultant fee. The third invoice would be for an additional 10% (cumulative 70%) of the proposed consultant fee. The fourth would be for an additional 20% (cumulative 90%) of the proposed consultant fee. And then a final 10% (cumulative 100%) of the proposed consultant fee would be paid when the project is complete. Note that these invoices may not necessarily come in on a monthly basis since they are tied to actual progress on the project. 2) For projects that do not a public hearing the invoices would also track the progress on the project but only require 2 payments. The first invoice would be a maximum of 50% of the proposed consultant fee. The second invoice would be for the balance 50% (cumulative 100%) of the proposed consultant fee, paid after the project is complete. Note that these invoices may not necessarily come in on a monthly basis since they are tied to actual progress on the project. As the vendor is required to submit a monthly invoice for the types of project listed above, the invoice should properly track each assignment and would simply state "No payment due for this project this month" when that is the case. When the payable activity occurs that particularly monthly invoice would reflect that activity accordingly.

3. The Consultant will obtain, and keep current during the term of this Agreement, the required City of Moreno Valley business license. Proof of a current City of Moreno Valley business license will be required prior to any payments by the City. Any invoice not paid because the proof of a current City of Moreno Valley business license has not been provided will not incur any fees, late charges, or other penalties. Complete instructions for obtaining a City of Moreno Valley business license are located at: http://www.moval.org/city_hall/departments/fin-man-serv/b-license.shtml

3. The Consultant will electronically submit an invoice to the City once a month for progress payments along with documentation evidencing services completed to date. The progress payment is based on actual time and materials expended in furnishing authorized professional services during the preceding calendar month. At no time will the City pay for more services than have been satisfactorily completed and the City Engineer's determination of the amount due for any progress payment shall be final. The consultant will submit all original invoices to Accounts Payable staff at AccountsPayable@moval.org
Accounts Payable questions can be directed to (951) 413-3073.
Copies of invoices may be submitted to the Planning Division at planning@moval.org or calls directed to (951) 413-3206.

4. The Consultant agrees that City payments will be received via Automated Clearing House (ACH) Direct Deposit and that the required ACH Authorization form will be completed prior to any payments by the City. Any invoice not paid because the completed ACH Authorization Form has not been provided will not incur any fees, late charges, or other penalties. The ACH Authorization Form is located at:

http://www.moval.org/city_hall/forms.shtml#bf

5. The minimum information required on all invoices is:
 - A. Vendor Name, Mailing Address, and Phone Number
 - B. Invoice Date
 - C. Vendor Invoice Number
 - D. City-provided Reference Number (e.g. Project, Activity)
 - E. Detailed work hours by class title (e.g. Manager, Technician, or Specialist), services performed and rates, explicit portion of a contract amount, or detailed billing information that is sufficient to justify the invoice amount; single, lump amounts without detail are not acceptable.

6. The City shall pay the Consultant for all invoiced, authorized professional services within thirty (30) days of receipt of the invoice for same.

EXHIBIT D**INSURANCE REQUIREMENTS****Minimum Scope of Insurance**

Coverage shall be at least as broad as:

1. The most current version of Insurance Services Office (ISO) Commercial General Liability Coverage Form CG 00 01, which shall include insurance for “bodily injury,” “property damage” and “personal and advertising injury” with coverage for premises and operations, products and completed operations, and contractual liability.
2. The most current version of Insurance Service Office (ISO) Business Auto Coverage Form CA 00 01, which shall include coverage for all owned, hired, and non-owned automobiles or other licensed vehicles (Code 1- Any Auto).
3. Workers’ Compensation insurance as required by the California Labor Code and Employer’s Liability Insurance.
4. Professional Liability (Errors and Omissions) insurance appropriate to Consultant’s profession.

Minimum Limits of Insurance

Consultant shall maintain limits of liability of not less than:

1. General Liability:
 - \$1,000,000 per occurrence for bodily injury and property damage
 - \$1,000,000 per occurrence for personal and advertising injury
 - \$2,000,000 aggregate for products and completed operations
 - \$2,000,000 general aggregate
2. Automobile Liability:
 - \$1,000,000 per accident for bodily injury and property damage
3. Employer’s Liability:
 - \$1,000,000 each accident for bodily injury
 - \$1,000,000 disease each employee
 - \$1,000,000 disease policy limit

4. Professional Liability (Errors and Omissions):

\$1,000,000 per claim/occurrence
\$2,000,000 policy aggregate

Umbrella or Excess Insurance

In the event Consultant purchases an Umbrella or Excess insurance policy(ies) to meet the “Minimum Limits of Insurance,” this insurance policy(ies) shall “follow form” and afford no less coverage than the primary insurance policy(ies).

Deductibles and Self-Insured Retentions

Consultant shall be responsible for payment of any deductibles contained in any insurance policy(ies) required hereunder and Consultant shall also be responsible for payment of any self-insured retentions. Any deductibles or self-insured retentions must be declared to, and approved by, the City Manager or his/her designee. At the option of the City Manager or his/her designee, either (i) the insurer shall reduce or eliminate such deductibles or self-insured retentions as respects City, CSD, Housing Authority and each of their officers, officials, employees, agents and volunteers; or (ii) Consultant shall provide a financial guarantee, satisfactory to the City Manager or his/her designee, guaranteeing payment of losses and related investigations, claim administration and defense expenses. At no time shall City be responsible for the payment of any deductibles or self-insured retentions.

Other Insurance Provisions

The General Liability and Automobile Liability insurance policies are to contain, or be endorsed to contain, the following provisions:

1. City, CSD, Housing Authority and each of their officers, officials, employees, agents and volunteers are to be covered as additional insureds.
2. The coverage shall contain no special limitations on the scope of protection afforded to City, CSD, Housing Authority and each of their officers, officials, employees, agents and volunteers.
3. Consultant’s insurance coverage shall be primary and no contribution shall be required of City.

The Workers’ Compensation insurance policy is to contain, or be endorsed to contain, the following provision: Consultant and its insurer shall waive any right of subrogation against City, CSD, Housing Authority and each of their officers, officials, employees, agents and volunteers.

If the Professional Liability (Errors and Omissions) insurance policy is written on a claims-made form:

1. The retroactive date must be shown, and must be before the effective date of the Agreement or the commencement of work by Consultant.
2. Insurance must be maintained and evidence of insurance must be provided for at least 3 years after any expiration or termination of the Agreement or, in the alternative, the policy shall be endorsed to provide not less than a 3-year discovery period.
3. If coverage is canceled or non-renewed, and not replaced with another claims-made policy form with a retroactive date prior to the effective date of the Agreement or the commencement of work by Consultant, Consultant must purchase extended reporting coverage for a minimum of 3 years following the expiration or termination of the Agreement.
4. A copy of the claims reporting requirements must be submitted to City for review.
5. These requirements shall survive expiration or termination of the Agreement.

All policies of insurance required hereunder shall be endorsed to provide that the coverage shall not be cancelled, non-renewed, reduced in coverage or in limits except after 30 calendar day written notice by certified mail, return receipt requested, has been given to City. Upon issuance by the insurer, broker, or agent of a notice of cancellation, non-renewal, or reduction in coverage or in limits, Consultant shall furnish City with a new certificate and applicable endorsements for such policy(ies). In the event any policy is due to expire during the work to be performed for City, Consultant shall provide a new certificate, and applicable endorsements, evidencing renewal of such policy not less than 15 calendar days prior to the expiration date of the expiring policy.

Acceptability of Insurers

All policies of insurance required hereunder shall be placed with an insurance company(ies) admitted by the California Insurance Commissioner to do business in the State of California and rated not less than "A-VII" in Best's Insurance Rating Guide; or authorized by the City Manager or his/her designee.

Verification of Coverage

Consultant shall furnish City with all certificate(s) and **applicable endorsements** effecting coverage required hereunder. All certificates and **applicable endorsements** are to be received and approved by the City Manager or his/her designee prior to City's execution of the Agreement and before work commences.



Report to City Council

TO: Mayor and City Council
 Mayor and City Council Acting in its Capacity as President and Members of the Board of Directors of the Moreno Valley Community Services District (CSD)

FROM: Mel Alonzo, Parks & Community Services Director

AGENDA DATE: December 19, 2017

TITLE: APPROVE AND EXECUTE AGREEMENT FOR THE INSTALLATION OF A MODULAR RESTROOM AND PICNIC SHELTER AT JOHN F. KENNEDY VETERANS MEMORIAL PARK

RECOMMENDED ACTION

Recommendations:

1. Approve the Agreement for the Installation of a Modular Restroom and Picnic Shelter at John F. Kennedy Veterans Memorial Park with KASA Construction Inc.
2. Authorize the Executive Director to execute the Agreement for the Installation of a Modular Restroom and Picnic Shelter at John F. Kennedy Veterans Memorial Park with KASA Construction Inc.; and issuance of the Purchase Order for construction beginning once the Agreement has been fully executed.
3. Authorize the Executive Director to execute any subsequent related Extensions or Amendments to the Agreement, subject to the approval of the City Attorney.
4. Authorize the Parks and Community Services Director to accept the improvements into the Community Services District's maintained system upon acceptance of the improvements as complete.

SUMMARY

Award the agreement for the John F. Kennedy Veterans Memorial Park Modular Restroom and Picnic Shelter.

DISCUSSION

This project is fully funded by the State of California Department of Housing and Community Development. John F. Kennedy Veterans Memorial Park (hereinafter referred to as “JFK Park”) is one of the City’s oldest parks that is deficient of separate Americans with Disabilities Act (ADA) men/women accessible restrooms and a picnic shelter that houses more than one table. Due to funding constraints, the Park and Community Services Department sought out a grant that could provide these amenities. The project at JFK Park fit into the criteria of this State program. Once the grant was approved, staff moved forward on the designing and construction of the project that was approved by the State for grant funding. An architect was hired through the City’s on-call consultant list for the project and the project was designed.

Modular restrooms are built off-site and offer the basics of public restrooms. They are typically designed of concrete block and steel. They can have a storage space for supplies but typically not much else. On the positive side, modular restrooms cost less than a custom-built product and can be constructed in less time.

The John F. Kennedy Veterans Memorial Park Modular Restroom and Picnic Shelter was bid through Planet Bids and opened in November 21, 2017. There were four bids submitted on this project. The apparent low bidder is KASA Construction Inc., for the base bid. The base bid provides all the components necessary for this project, fits into the available grant funding budget, and is within the ADA Park Improvement budget. There were no alternate items in this bid. The Department recommends that the base bid be awarded to KASA Construction, Inc. The total contract will be \$636,525, which reflects a \$70,000 contingency.

ALTERNATIVES

1. (a) Approve the Agreement for the Installation of a Modular Restroom and Picnic Shelter at John F. Kennedy Veterans Memorial Park with KASA Construction Inc.;
- (b) Authorize the Executive Director to execute the Agreement for the Installation of a Modular Restroom and Picnic Shelter at John F. Kennedy Veterans Memorial Park with KASA Construction, Inc.; and issuance of the Purchase Order for construction beginning once the Agreement has been fully executed;
- (c) Authorize the Executive Director to execute any subsequent related Extensions or Amendments to the Agreement within the authorized funding, subject to the approval of the City Attorney; and
- (d) Authorize the Parks and Community Services Director to accept the improvements into the Community Services District’s maintained system upon acceptance of the improvements as complete.

2. Elect not to award an Agreement for the Installation of a Modular Restroom and Picnic Shelter at John F. Kennedy Veterans Memorial Park with KASA

Construction, Inc.; do not authorize the Executive Director to execute the Agreement for the Installation of a Modular Restroom and Picnic Shelter at John F. Kennedy Veterans Memorial Park with KASA Construction, Inc.; and issuance of the Purchase Order for construction beginning once the Agreement has been fully executed; do not authorize the Executive Director to execute any subsequent related Extensions or Amendments to the Agreement, subject to the approval of the City Attorney; do not authorize the Parks and Community Services Director to accept the improvements into the Community Services District's maintained system upon acceptance of the improvements as complete; and provide further direction to staff.

FISCAL IMPACT

There is no direct impact to the General Fund.

Funding is available in the following approved CIP projects: \$383,360.47 from Acct. 2300-50-57-35214, Project No. PCS HSG GR-JFK Reno (Housing-Related Parks Grant 2015), and \$253,164.53 from Acct 3006-50-57-80007-720134, Project No. 807 0005 50 57-3006Q-04 (Annual ADA improvements).

NOTIFICATION

Posting of the agenda

PREPARATION OF STAFF REPORT

Prepared By:
Tony Hetherman
Parks Projects Coordinator

Department Head Approval:
Mel Alonzo
Parks and Community Services Director

CITY COUNCIL GOALS

Public Facilities and Capital Projects. Ensure that needed public facilities, roadway improvements, and other infrastructure improvements are constructed and maintained.

Positive Environment. Create a positive environment for the development of Moreno Valley's future.

Community Image, Neighborhood Pride and Cleanliness. Promote a sense of community pride and foster an excellent image about our City by developing and executing programs which will result in quality development, enhanced neighborhood preservation efforts, including home rehabilitation and neighborhood restoration.

CITY COUNCIL STRATEGIC PRIORITIES

1. Economic Development

- 2. Public Safety
- 3. Library
- 4. Infrastructure
- 5. Beautification, Community Engagement, and Quality of Life
- 6. Youth Programs

Objective 5.2: Promote the installation and maintenance of cost effective, low maintenance landscape, hardscape and other improvements which create a clean, inviting community.

Objective 5.5: Promote a healthy community and lifestyle.

Objective 6.2: Improve health, wellness and fitness for Moreno Valley youth through recreation and sports programs.

ATTACHMENTS

- 1. KASA Construction Inc - Public Works Construction Agreement - JFK RENO
- 2. Request for Bid PCS HSG GR-JFK RENO_AD FINAL PB
- 3. Special Provisions PCS HSG GR-JFK RENO
- 4. JFK spreadsheet

APPROVALS

| | | |
|-------------------------|-------------------|-------------------|
| Budget Officer Approval | <u>✓ Approved</u> | 12/04/17 9:37 AM |
| City Attorney Approval | <u>✓ Approved</u> | 12/05/17 12:50 PM |
| City Manager Approval | <u>✓ Approved</u> | 12/07/17 2:18 PM |

Moreno Valley Community Services District of the City of Moreno Valley

**PUBLIC WORKS AGREEMENT
 BID # 2018-008
 JOHN F. KENNEDY VETERANS MEMORIAL PARK
 RESTROOM IMPROVEMENTS
 PROJECT NO. PCS HSG GR - JFK RENO**

This Public Works Agreement ("Agreement") is made and entered into this ____ day of _____, 20____, by and between Moreno Valley Community Services District, a district formed pursuant to California Community Services District Law, County of Riverside, State of California, hereinafter sometimes referred to as the "Agency," and KASA Construction Inc., a corporation, hereinafter referred to as the "Contractor," with respect to the following:

- A. The Agency desires to retain Contractor, on an independent contractor basis, to perform construction services for John F. Kennedy Veterans Memorial Park, located at 15115 Indian Street, Moreno Valley, California ("Project," as described in Section 2 of this Agreement); and
- B. The public interest, convenience, necessity and general welfare will be served by this Agreement; and
- C. This Project is subject to payment of prevailing wages per the State Labor Code; and
- D. This Agreement is made and entered into the date Agency signs this Agreement.
- E. In the event of any conflict in the provisions thereof, the terms of said Bid Documents as set forth above shall control, each over the other, in the order provided. The above items are incorporated in this Agreement as though set forth in full.
 - a. This Agreement.
 - b. Any and all Contract Change Orders issued after execution of this Agreement.
 - c. Addenda Nos. 1 through 5, inclusive, issued prior to the opening of the Bids.
 - d. The Bid Documents.
 - e. The Special Provisions which include the General Provisions, Technical Provisions, and Appendices, all of which are parts of this Agreement.
 - f. The project Plans.
 - g. The City Standard Plans.
 - h. The Standard Specifications.
 - i. Reference Specifications, all of which are essential parts of this Agreement.
 - j. The Bidder's Proposal which includes the Bidder's Bond and Noncollusion Affidavit.

That the City and the Contractor for the consideration hereinafter named, agree as follows:

1. CONTRACTOR INFORMATION:

KASA Construction Inc.
 15148 Sierra Bonita Lane
 Chino, CA 91710
 Business Phone: 951.606.8056
 Email: Hectorz@kasaconstruction.com
 Business License Number:
 Federal Tax I.D. Number: 26-3647498
 Contractor's License#: CA 927544
 License Classification(s): A, B, C-27, C-10
 DIR PWC Registration: 100006013

| |
|--------------------------|
| For Department use only. |
| DIR ID # _____ |
| CITY CONTRACT # _____ |
| P.O. # _____ |

Attachment: KASA Construction Inc - Public Works Construction Agreement - JFK RENO (2845 : APPROVE AND EXECUTE AGREEMENT FOR

2. CONTRACTOR SERVICES, FEES, AND RELEVANT DATES:

- A. The Contractor's scope of service is described in on page 1, E.1.a-j, referenced herein and referred as "Project".
- B. The Agency's responsibility, other than payment, is described in Exhibit A attached hereto and incorporated herein by this reference.
- C. Payment terms are provided in Exhibit B attached hereto and incorporated herein by this reference.
- D. The Contractor shall furnish all materials, tools, equipment and labor, except as otherwise provided in the Plans or Special Provisions, and will perform all the work which is necessary to complete in a good, workmanlike and substantial manner the above said project in accordance with the Bid Documents for this project, the Bid Documents which are hereby specifically referred to and by such reference made a part hereof.
- E. In the event any conflict exists between the Agreement minus the Scope of Services, on the one hand, and the Scope of Services, on the other hand, the former shall supersede.
- F. The Parties agree that the specifications, standards, and procedures set forth in the 2015 Greenbook: Standard Specifications for Public Works Construction ("Greenbook") and the 2016 California Building Standards Code ("CBSC") (together, "Public Works Authority") shall govern the completion of the Project, and to such extent the Public Works Authority is incorporated herein by this reference; provided, however, in the event any conflict exists between this Agreement and the Public Works Authority, this Agreement shall supersede unless otherwise required by law.
- G. The Agreement shall commence on the date it is signed by the Agency and shall expire two (2) years following the City's acceptance of the work, pursuant to this Agreement, or release of the Performance Bond, whichever occurs first.
- H. The Contractor's starting date is the date listed on the issued Purchase Order, which will be utilized as the "Notice to Proceed." The Contractor agrees to diligently prosecute the contracted work for the Project to completion within **One Hundred, Ten (110) working days** after said date in the "Notice to Proceed." The Agency acknowledges that it will not unreasonably withhold approval of the Contractor's requests for extensions of time in which to complete the work required. The Contractor shall not be responsible for performance delays caused by others or delays beyond the Contractor's reasonable control (excluding delays caused by non-performance or unjustified delay by Contractor, his/her/its employees, or subcontractors), and such delays shall extend the time for performance of the work by the Contractor.
- I. The work performed in this Agreement shall be performed Monday through Friday, 7 a.m. to 5 p.m. Agency observed holidays shall be observed by the Contractor and no work shall be performed on these dates, unless prior written permission is granted.
- J. Substantial completion of work shall be evidenced by inspection and approval by Agency staff in writing.

3. LABOR LAWS AND PREVAILING WAGES

- A. All work or services performed within the State of California pursuant to this Agreement by Contractor, Contractor's employees and independent contractors, or Contractor's subcontractors and its subcontractors' employees and independent contractors shall be performed by individuals lawfully permitted to perform such work or services in the State of California and/or the United States of America pursuant to all applicable State and/or Federal labor laws, rules and regulations including, but not limited to, any State or

- Federal law, rule or regulation prohibiting the employment of undocumented workers or any other person not lawfully permitted to perform said work or services in the State of California or the United States of America.
- B. Contractor represents that it is an equal opportunity employer and shall not discriminate against any subcontractor, employee, or applicant (“person”) for employment because of denial of family and medical care leave; race; religious creed (including religious dress and grooming practices); color; national origin (including language use restrictions); ancestry; physical disability or mental disability (including HIV and Aids); medical condition (cancer and genetic characteristics); genetic information; military or veteran status; marital status; gender, gender identity, and gender expression; sex (which includes pregnancy, childbirth, breastfeeding and medical conditions related to pregnancy, childbirth or breastfeeding); age or sexual orientation. Unless otherwise permitted under the law, Contractor shall not refuse to hire or employ any such person or refuse to select any such person for a training program leading to employment, or bar or discharge any such person from employment or from a training program leading to employment, or otherwise discriminate against any such person in compensation or in terms, conditions, or privileges of employment.
- C. Contractor and all of Contractor’s subcontractors, if any, shall pay each employee engaged in all applicable trades or occupation not less than the prevailing hourly wage rate for work of a similar character in the locality in which the public work is performed, and not less than the general prevailing rate of per diem wages for holiday and overtime work. In accordance with the provisions of Section 1770 of the California Labor Code (“Labor Code”), the Director of Department of Industrial Relations of the State of California has determined the general prevailing rates of wages and employer payments for health and welfare, pension, vacation, travel time, and subsistence pay as provided for in Labor Code Section 1773.8, apprenticeship or other training programs authorized by Labor Code Section 3093 and similar purposes applicable to the work to be done. Said wages are available through the California Department of Industrial Relations’ Internet website at <http://www.dir.ca.gov/dlsr/PWD/index.htm> and are on file at City Hall, as provided in Section 1773.2 of the Labor Code. Said rates shall be posted at the Project site where work is to be performed, in accordance with Labor Code Section 1773.2. Contractor shall access a copy of the wage rate determination and shall make all subcontractors, if any, aware of the determination. As the wage determination for each craft reflects an expiration date, it shall be the Contractor’s responsibility to ensure that the prevailing wage rates of concern are current and paid. Subject to the safe harbor provisions of Labor Code Section 1775, Contractor shall forfeit to the Agency an amount not to exceed two hundred dollars (\$200) for each calendar day or portion thereof, as set by the Labor Commissioner in accordance with the terms of Labor Code section 1775, for each laborer, workmen or mechanics employed that is paid less than the general prevailing rate of wages herein referred to and stipulated for any work done under the proposed contract, by him, or by any subcontractor under him, in violation of the provisions of the Labor Code, and in particular, Sections 1770 to 1781 inclusive. Contractor and any and all or its subcontractors shall forfeit to the Agency twenty-five dollars (\$25) for each worker employed in the performance of this Agreement for each calendar day during which the worker is required or permitted to work more than eight (8) hours in any one calendar day and forty (40) hours in any one calendar week in violation of the provisions of Section 1813 of the Labor Code. In the event the total cost of the Project is thirty thousand dollars (\$30,000.00) or more, Contractor shall further comply with provisions set forth in Labor Code Section 1777.5 pertaining to employment of properly registered apprentices, including without limitation the obligation to (i) pay employed apprentices the prevailing rate of per diem wages for apprentices in the trade to which he or she is registered and shall be employed only at the work of craft or trade to which he or she is registered; (ii) employ apprentices in at least the ratio as set forth in

- said section; (iii) submit contract award information to an applicable apprenticeship program; and (iv) contribute to California Apprenticeship Council.
- D. Contractor and all subcontractors hired to perform any work under the Project shall keep accurate payroll records, including the name, address, social security number, work classification, straight time and overtime hours worked each day and week, and the actual per diem wages paid to each worker, in accordance with Section 1776 of the Labor Code. Payroll records shall be on forms provided by the Division of Labor Standards Enforcement ("DLSE") or in a manner containing the same information as the forms provided by the DLSE. Failure to comply with the above may result in monetary penalties to the Contractor or affected subcontractor. Payroll records shall be verified by written declaration made under penalty of perjury, that the information contained in the records is true and correct. Contractor and any and all subcontractors shall make a certified copy of all payroll records available for inspection by DLSE, the Agency or any member of the public and otherwise provide certified copies of such records to any of the foregoing within ten (10) days of Contractor's and subcontractor's receipt of written request therefor. Failure to comply with the above may result in monetary penalties, in accordance with Labor Code Section 1776(d) and (h).
- E. Notwithstanding anything else to the contrary, Contractor hereby acknowledges that all contractors must be registered with the Department of Industrial Relations ("Department") pursuant to Labor Code Section [1725.5](#) in order to be qualified to bid on, be listed in a bid proposal, subject to the requirements of Section 4104 of the Public Contract Code, or engage in the performance of any public work contract, including this Agreement, that is subject to the payment of prevailing wages. Contractor represents and warrants that Contractor is [registered](#) with the Department in the manner prescribed by the Department and has paid the requisite application fee, as required by Labor Code Section 1725.5. Ready-mix haulers and companies that deliver ready-mixed concrete for public works projects are considered subcontractors under Labor Code section [1722.1](#) and must [register](#) with the Department of Industrial Relations as specified in Labor Code section [1725.5](#). Moreover, prior to Contractor entering into any contracts with any subcontractor, Contractor shall obtain proof that all such subcontractors have also registered with the Department in accordance with Section [1725.5](#).

4. STANDARD TERMS AND CONDITIONS:

- A. Control of Work. Contractor is solely responsible for the content and sequence of the work, and will not be subject to control and direction as to the details and means for accomplishing the anticipated results of services. The Agency will not provide any training to Contractor or his/her/its employees.
- B. Intent of Parties. Contractor is, and at all times shall be, an independent contractor and nothing contained herein shall be construed as making the Contractor or any individual whose compensation for services is paid by the Contractor, an agent or employee of the City and/or CSD, or authorizing the Contractor to create or assume any obligation or liability for or on behalf of the Agency, or entitling the Contractor to any right, benefit, or privilege applicable to any officer or employee of the Agency.
- C. Subcontracting. Contractor may retain or subcontract for the services of other necessary contractors with the prior written approval of the Agency. Payment for such services shall be the responsibility of the Contractor.
- D. Extra Work and Change Orders. Extra work and change orders shall become a part of this Agreement once the extra work or change order is approved in writing and signed by the Agency and Contractor, prior to the commencement of any extra work or change in work covered by the change order. The Agency's form change order shall be used for both extra work and a change in work. The change order must describe the scope of the extra work or change in work, and the cost to be added or subtracted from this

- Agreement. The Agency shall not require Contractor to perform any extra work or a change in work without written authorization. A change order shall not be enforceable against the Agency unless the change order complies with this provision.
- E. Conformance to Applicable Requirements. All work prepared by Contractor shall be subject to the approval of Agency.
- F. Contractor's Representative. Contractor hereby designates Hector Zavala, or his or her designee, to act as its representative for the performance of this Agreement ("Contractor's Representative"). Contractor's Representative shall have full authority to represent and act on behalf of the Contractor for all purposes under this Agreement. The Contractor's Representative shall supervise and direct the services, using his or her best skill and attention, and shall be responsible for all means, methods, techniques, sequences and procedures and for the satisfactory coordination of all portions of the services under this Agreement.
- G. Substitution of Key Personnel. Contractor has represented to Agency that certain key personnel will perform and coordinate the services under this Agreement. Should one or more of such personnel become unavailable, Contractor may substitute other personnel of at least equal competence upon written approval of Agency. In the event that Agency and Contractor cannot agree as to the substitution of key personnel, Agency shall be entitled to terminate this Agreement for cause. As discussed below, any personnel who fail or refuse to perform the services in a manner acceptable to the Agency, or who are determined by the Agency to be uncooperative, incompetent, a threat to the adequate or timely completion of the Project or a threat to the safety of persons or property, shall be promptly removed from the Project by the Contractor at the request of the Agency. The key personnel for performance of this Agreement are as follows: Hector Zavala.
- H. Agency's Representative. The Agency hereby designates the Director of Parks and Community Services of the City of Moreno Valley, or his or her designee, to act as its representative for the performance of this Agreement ("Agency's Representative"). Contractor shall not accept direction or orders from any person other than the Agency's Representative or his or her designee. The Agency's representatives are as follow: Tony Hetherman.
- I. Standard of Care; Performance of Employees. Contractor shall perform all services under this Agreement in a skillful and competent manner, consistent with the standards generally recognized as being employed by professionals in the same discipline in the State of California. Contractor represents and maintains that it is skilled in the profession necessary to perform the services. Contractor warrants that all employees and subcontractors shall have sufficient skill and experience to perform the services assigned to them. Finally, Contractor represents that it, its employees and subcontractors have all licenses, permits, qualifications and approvals of whatever nature that are legally required to perform the services and that such licenses and approvals shall be maintained throughout the term of this Agreement. Any employee of the Contractor or its subcontractors who is determined by the Agency to be uncooperative, incompetent, a threat to the adequate or timely completion of the Project, a threat to the safety of persons or property, or any employee who fails or refuses to perform the services in a manner acceptable to the Agency, shall be promptly removed from the Project by the Contractor and shall not be re-employed to perform any of the services or to work on the Project.
- J. Legal Considerations. The Contractor shall comply with applicable federal, state, and local laws, rules and regulations in the performance of this Agreement.
- K. Contractor Indemnification. To the fullest extent permitted by law, the Contractor assumes liability for and agrees, at the Contractor's sole cost and expense, to promptly and fully indemnify, protect, hold harmless and defend (even if the allegations are false, fraudulent, or groundless), the Moreno Valley Community Services District (sometimes "CSD"), the City of Moreno Valley (sometimes "City"), the City Council and Board of

Directors and each member thereof, and the Moreno Valley Housing Authority and all of their respective officials, officers, directors, employees, commission members, representatives and agents (collectively “Indemnitees” and singularly “Indemnitee”), from and against any and all claims, allegations, actions, suits, arbitrations, administrative proceedings, regulatory proceedings, or other legal proceeds, causes of action, demands, costs, judgments, liens, stop notices, penalties, liabilities, damages, losses, anticipated losses of revenues, and expenses (including, but not limited to, any fees of accountants, attorneys, experts or other professionals, or investigation expenses), or losses of any kind or nature whatsoever, whether actual, threatened or alleged, arising out of, resulting from, or in any way (either directly or indirectly), related to the work or the Project or any breach of this Agreement by Contractor or any of its officers, agents, employees, subcontractors, sub-subcontractors, or any person performing any of the work, pursuant to a direct or indirect contract with the Contractor (“Indemnity Claims”). Such Indemnity Claims include, but are not limited to, claims for:

1. Any activity on or use of the CSD’s and/or City’s premises or facilities;
2. Any liability incurred due to Contractor acting outside the scope of its authority pursuant to this Agreement, whether or not caused in part by an Indemnitee;
3. The failure of Contractor or the work to comply with any applicable law, permit or orders;
4. Any misrepresentation, misstatement or omission with respect to any statement made in this Agreement or any document furnished by the Contractor in connection therewith;
5. Any breach of any duty, obligation or requirement under this Agreement or any document furnished by Contractor in connection therewith, including, but not limited to any breach of Contractor’s warranties, representations or agreements;
6. Any failure to coordinate the work with Agency’s separate contractors;
7. Any failure to provide notice to any party as required by this Agreement or any document furnished in connection therewith;
8. Any failure to act in such a manner as to protect the Project from loss, cost, expense or liability;
9. Damage or injury to real property or personal property, equipment and materials (including, but without limitation, property under the care and custody of the Contractor or the City and/or CSD), and injury or death sustained by any person or persons (including, but not limited to, Contractor’s employees or agents, and members of the general public);
10. Any liability imposed by applicable law including, but not limited to criminal or civil fines or penalties;
11. Any dangerous, hazardous, unsafe or defective condition of, in or on the Project site, of any nature whatsoever, which may exist by reason of any act, omission, neglect, or any use or occupation of the site by Contractor, its officers, agents, employees, or subcontractors;
12. Any operation conducted upon or any use or occupation of the Project site by Contractor, its officers, agents, employees, or subcontractors under or pursuant to the provisions of this Agreement or otherwise;
13. Any acts, errors, omission or negligence of Contractor, its officers, agents, employees, or subcontractors;
14. Infringement of any patent rights, licenses, copyrights or intellectual property which may be brought against the Contractor or Agency arising out of Contractor’s work, for which the Contractor is responsible; and
15. Any and all claims against the Agency seeking compensation for labor performed or materials used or furnished to be used in the work or alleged to have been furnished on the Project, including all incidental or consequential damages resulting to the Agency from such claims.

- L. Indemnitees' Active Negligence. Contractor's obligations to indemnify and hold the Indemnitees harmless **exclude** only such portion of any Indemnity Claim which is attributable to the active negligence or willful misconduct of the Indemnitees, provided such active negligence or willful misconduct is determined by agreement of the parties or by findings of a court of competent jurisdiction. In instances where an Indemnitee's active negligence accounts for only a percentage of the liability for the Indemnity Claim involved, the obligation of Contractor will be for that entire percentage of liability for the Indemnity Claim not attributable to the active negligence or willful misconduct of the Indemnitee(s). Such obligation shall not be construed to negate, abridge or otherwise reduce any other right or obligation of indemnity which would otherwise exist as to any party or person described in this section. Subject to the limits set forth herein, the Contractor, at its own expense, shall satisfy any resulting judgment that may be rendered against any Indemnitee resulting from an Indemnity Claim. The Indemnitees shall be consulted with regard to any proposed settlement.
- M. Independent Defense Obligation. The duty of the Contractor to indemnify and hold harmless the Indemnitees includes the separate and independent duty to defend the Indemnitees, which duty arises immediately upon receipt by Contractor of the tender of any Indemnity Claim from an Indemnitee. The Contractor's obligation to defend the Indemnitee(s) shall be at Contractor's sole expense, and not be excused because of the Contractor's inability to evaluate liability or because the Contractor evaluates liability and determines that the Contractor is not liable. This duty to defend shall apply whether or not an Indemnity Claim has merit or is meritless, or which involves claims or allegations that any or all of the Indemnitees were actively, passively, or concurrently negligent, or which otherwise asserts that the Indemnitees are responsible, in whole or in part, for any Indemnity Claim. The Contractor shall respond within thirty (30) calendar days to the tender of any Indemnity Claim for defense and/or indemnity by an Indemnitee, unless the Indemnitee agrees in writing to an extension of this time. The defense provided to the Indemnitees by Contractor shall be by well qualified, adequately insured and experienced legal counsel acceptable to the Agency.
- N. Intent of Parties Regarding Scope of Indemnity. It is the intent of the parties that the Contractor and its subcontractors of all tiers shall provide the Indemnitees with the broadest defense and indemnity permitted by applicable law. In the event that any of the defense, indemnity or hold harmless provisions in the Agreement are found to be ambiguous, or in conflict with one another, it is the parties' intent that the broadest and most expansive interpretation in favor of providing defense and/or indemnity to the Indemnitees be given effect.
- O. Waiver of Indemnity Rights Against Indemnitees. With respect to third party claims against the Contractor, to the fullest extent permitted by law, the Contractor waives any and all rights to any type of express or implied indemnity against the Indemnitees.
- P. Subcontractor Requirements. In addition to the requirements set forth hereinabove, Contractor shall ensure, by written subcontract agreement, that each of Contractor's subcontractors of every tier shall protect, defend, indemnify and hold harmless the Indemnitees with respect to Indemnity Claims arising out of, in connection with, or in any way related to each such subcontractors' work on the Project in the same manner in which Contractor is required to protect, defend, indemnify and hold the Indemnitees harmless. In the event Contractor fails to obtain such defense and indemnity obligations from others as required herein, Contractor agrees to be fully responsible to the Indemnitees according to the terms of this section.
- Q. No Limitation or Waiver of Rights. Contractor's obligations under this section are in addition to any other rights or remedies which the Indemnitees may have under the law or under the Agreement. Contractor's indemnification and defense obligations set forth in this section are separate and independent from the insurance provisions set forth in the Agreement, and do not limit, in any way, the applicability, scope, or obligations set

forth in such insurance provisions. The purchase of insurance by the Contractor with respect to the obligations required herein shall in no event be construed as fulfillment or discharge of such obligations. In any and all claims against the Indemnitees by any employee of the Contractor; any subcontractor; any supplier of the Contractor or subcontractors; anyone directly or indirectly employed by any of them; or anyone for whose acts any of them may be liable, the obligations under this Agreement shall not be limited in any way by any limitation on the amount or type of damages, compensation or benefits payable by or for the Contractor or any subcontractor or any supplier of either of them, under workers' compensation acts, disability benefit acts or other employee benefit acts. Failure of the Agency to monitor compliance with these requirements imposes no additional obligations on the Agency and will in no way act as a waiver of any rights hereunder.

- R. Withholding to Secure Obligations. Subject to applicable law, in the event a claim arises prior to final payment to Contractor, the Agency may, in its sole discretion, reserve, retain or apply any monies due Contractor for the purpose of resolving such claims; provided, however, the Agency may release such funds if the Contractor provides the Agency with reasonable assurances of protection of the Indemnitees' interests. The Agency shall, in its sole discretion, determine whether such assurances are reasonable.
- S. Survival of Indemnity Obligations. Contractor's obligations under this section are binding on Contractor's and its subcontractors' successors, heirs and assigns and shall survive the completion of the work or termination of the Contractor's performance of the work.
- T. Insurance Requirements. The Contractor shall procure and maintain at its sole expense and throughout the term of this Agreement and any extension thereof, Commercial General Liability, Automobile Liability, and Workers' Compensation Insurance with such coverage limits as described herein.
- U. Additional Insured Endorsements. The Contractor shall provide Agency with certificates of insurance and endorsements as evidence of the insurance coverages required herein, and shall cause such certificates of insurance and endorsements to include:
“the City of Moreno Valley (City), the Moreno Valley Community Services District (CSD), the Moreno Valley Housing Authority, and their officers, officials, employees, agents, and volunteers are additional insureds as respects to General Liability and Auto Liability insurance. This insurance is primary, and our obligations are not affected by any other insurance carried by such additional insured whether primary, excess, contingent, or on any other basis. Waiver of subrogation for Workers' Compensation and Employer's Liability insurance as respects to the City of Moreno Valley (City), the Moreno Valley Community Services District (CSD), the Moreno Valley Housing Authority and each of their officers, officials, employees, agents, and volunteers.”
 For the Commercial General Liability coverage, said parties shall be named as additional insureds utilizing either:
 1. Insurance Services Office (“ISO”) Additional Insured endorsement CG 20 10 (04/13); or
 2. Substitute endorsements providing equivalent coverage, approved by the Agency.
 The endorsements shall be signed by a person authorized by the insurer to bind coverage on its behalf. The coverage shall contain no special limitations on the scope of protection afforded to such additional insureds. Coverage for such additional insureds does not extend to liability to the extent prohibited by Insurance Code Section 11580.4.
- V. Waivers of Subrogation. All policies of insurance required by the Agreement shall include or be endorsed to provide a waiver by the insurers of any rights of recovery or subrogation that the insurers may have at any time against the *“City of Moreno Valley (City), the Moreno Valley Community Services District (CSD), the Moreno Valley Housing Authority, and their officers, officials, employees, agents, and volunteers.”*

- W. Primary and Noncontributory Coverage. All policies and endorsements shall stipulate that the Contractor's (and the subcontractors') insurance coverage shall be primary and noncontributory insurance as respects the "*City of Moreno Valley (City), the Moreno Valley Community Services District (CSD), the Moreno Valley Housing Authority, and their officers, officials, employees, agents, and volunteers,*" and shall be excess of the Contractor's (and its subcontractors') insurance and shall not contribute with it. For the primary and noncontributory coverage, said parties shall be named as additional insureds utilizing either:
1. Insurance Services Office ("ISO") Additional Insured endorsement CG 20 10 (01/13); or
 2. Substitute endorsements providing equivalent coverage, approved by Agency.
- X. Coverage Applies Separately to Each Insured and Additional Insured. Coverage shall state that the Contractor's (and its subcontractors') insurance shall apply separately to each insured or additional insured against whom claim is made or suit is brought, except with respect to the limits of the insurer's liability. Coverage shall apply to any claim or suit brought by an additional insured against a named insured or other insured.
- Y. Self-Insurance. Any self-insurance (including deductibles or self-insured retention in excess of \$50,000) in lieu of liability insurance must be declared by Contractor and approved by the Agency in writing prior to execution of the Agreement. The Agency's approval of self-insurance, if any, is within the Agency's sole discretion and is subject to the following conditions:
- Contractor must, at all times during the term of the Agreement and for a period of at least **one (1)** year after completion of the Project maintain and upon Agency's reasonable request provide evidence of:
1. Contractor's "net worth" (defined as "total assets" [defined as all items of value owned by the Contractor including tangible items such as cash, land, personal property and equipment and intangible items such as copyrights and business goodwill]) minus total outside liabilities must be reflected in a financial statement for the prior fiscal year reflecting sufficient income and budget for Contractor to afford at least one loss in an amount equal to the amount of self-insurance;
 2. financial statements showing that Contractor has funds set aside/budgeted to finance the self-insured fund (i.e., Contractor has a program that fulfills functions that a primary insurer would fill); and
 3. a claims procedure that identifies how a claim is supposed to be tendered to reach the financing provided by the self-insured fund.
- If at any time after such self-insurance has been approved Contractor fails to meet the financial thresholds or otherwise fails to comply with the provisions set forth in this section, at the option of the Agency:
- a. the Contractor shall immediately obtain and thereafter maintain the third party insurance required under this section, and otherwise on the terms required above; or
 - b. the insurer shall reduce or eliminate such deductibles or self-insured retention as respects the "*City of Moreno Valley (City), the Moreno Valley Community Services District (CSD), the Moreno Valley Housing Authority, and their officers, officials, employees, agents, and volunteers,*" or
 - c. the Contractor shall procure a bond guaranteeing payment of losses and related investigation, claim administration, and defense expenses.
- Z. Insurer Financial Rating. Insurance companies providing insurance hereunder shall be rated A-:VII or better in Best's Insurance Rating Guide and shall be legally licensed and qualified to conduct insurance business in the State of California.
- AA. Notices to Agency of Cancellation or Changes. Each insurance policy described in this Agreement shall contain a provision or be endorsed to state that coverage will not be cancelled without **thirty (30) days'** prior written notice by certified or registered mail to the Agency (this obligation may be satisfied in the alternative by requiring such notice to

be provided by Contractor's insurance broker and set forth on its Certificate of Insurance provided to the Agency), except that cancellation for non-payment of premium shall require (10) days prior written notice by certified or registered mail. If an insurance carrier cancels any policy or elects not to renew any policy required to be maintained by Contractor pursuant to the Agreement, Contractor agrees to give written notice to the Agency at the address indicated in this Agreement. Contractor agrees to provide the same notice of cancellation and non-renewal to the Agency that is required by such policy(ies) to be provided to the First Named Insured under such policy(ies). Contractor shall provide confirmation that the required policies have been renewed not less than seven (7) days prior to the expiration of existing coverages and shall deliver renewal or replacement policies, certificates and endorsements to the City Clerk within fourteen (14) days of the expiration of existing coverages. Contractor agrees that upon receipt of any notice of cancellation or alteration of the policies, Contractor shall procure within five (5) days, other policies of insurance similar in all respects to the policy or policies to be cancelled or altered. Contractor shall furnish to the City Clerk copies of any endorsements that are subsequently issued amending coverage or limits within fourteen (14) days of the amendment.

BB. Commercial General Liability.

1. Coverage shall be written on an ISO Commercial General Liability "occurrence" form CG 00 01 (10/01 or later edition), Acord Certificate of Liability form 25 (2014/01), or equivalent form approved by the Agency for coverage on an occurrence basis. The insurance shall cover liability, including, but not limited to, that arising from premises operations, stop gap liability, independent contractors, products-completed operations, personal injury, advertising injury, and liability assumed under an insured contract. The policy shall be endorsed to provide the Aggregate Per Project Endorsement ISO form CG 25 03 (11/85) or equivalent form approved by the Agency. Coverage shall contain no contractors' limitation or other endorsement limiting the scope of coverage for liability arising from pollution, explosion, collapse, or underground (x, c, u) property damage. Contractor shall provide Products/Completed Operations coverage to be maintained continuously for a minimum of **one (1) year** after acceptance of the Project, and any extension of the one-year correction guarantee period after acceptance.

2. Contractor shall maintain Commercial General Liability insurance with the following minimum limits: \$1,000,000 per occurrence / \$2,000,000 aggregate / \$2,000,000 products-completed operations.

CC. Business Automobile Liability. Coverage shall be written on ISO form CA 00 01 (12/93 or later edition) or a substitute form providing equivalent coverage for owned, hired, leased and non-owned vehicles, whether scheduled or not, with \$1,000,000 combined single limit per accident for bodily injury and property damage. Additionally, the policy shall be endorsed utilizing ISO form CA 20 48 (10/14) or equivalent form.

DD. Workers' Compensation. Contractor shall comply with the applicable sections of the California Labor Code concerning workers' compensation for injuries on the job. Compliance is accomplished in one of the following manners:

1. Provide copy of permissive self-insurance certificate approved by the State of California; or

2. Secure and maintain in force a policy of workers' compensation insurance with statutory limits and Employer's Liability Insurance with a minimal limit of **\$1,000,000** per accident; or

3. Provide a "waiver" form certifying that no employees subject to the Labor Code's Workers' Compensation provision will be used in performance of this Agreement.

EE. Subcontractors' Insurance. The Contractor shall include all subcontractors as insureds under its policies or shall furnish separate certificates and endorsements for each subcontractor. All coverages for subcontractors shall be subject to all of the requirements stated herein.

- FF. Intellectual Property. Any system or documents developed, produced or provided under this Agreement, including any intellectual property discovered or developed by Contractor in the course of performing or otherwise as a result of its work, shall become the sole property of the Agency unless explicitly stated otherwise in this Agreement. The Contractor may retain copies of any and all material, including drawings, documents, and specifications, produced by the Contractor in performance of this Agreement. The Agency and the Contractor agree that to the extent permitted by law, until final approval by the Agency all data shall be treated as confidential and will not be released to third parties without the prior written consent of both parties.
- GG. Entire Agreement. This Agreement constitutes the entire agreement between the parties. There are no understandings, agreements, or representations of warranties, expressed or implied, not specified in this Agreement. This Agreement applies only to the current proposal as attached. This Agreement may be modified or amended only by a subsequent written Agreement signed by both parties. Assignment of this Agreement is prohibited without prior written consent.
- HH. Termination.
1. The Agency may terminate this Agreement without cause by giving at least ten (10) days written notice to the Contractor. The written notice shall specify the date of termination. Upon receipt of such notice, the Contractor may continue work through the date of termination, provided that no work or service(s) shall be commenced or continued after receipt of the notice which is not intended to protect the interest of the Agency. The Agency shall pay the Contractor within thirty (30) days after receiving any invoice after the date of termination for all non-objected to services performed by the Contractor in accordance herewith through the date of termination.
 2. Either party may terminate this Agreement for cause. In the event the Agency terminates this Agreement for cause, the Contractor shall perform no further work or service(s) under the Agreement unless the notice of termination authorizes such further work.
- II. Payment.
1. Payments to the Contractor pursuant to this Agreement will be reported to federal and state taxing authorities as required. Contractor is independently responsible for the payment of all applicable taxes. Where the payment terms provide for compensation on a time and materials basis, the Contractor shall maintain adequate records to permit inspection and audit of the Contractor's time and materials charges under the Agreement. Upon reasonable notice, such records must be made available to the Agency's agent; however, nothing herein shall convert such records into public records, unless otherwise required by law. Such records shall be retained by the Contractor for three (3) years following completion of the services under the Agreement.
 2. Pursuant to Public Contract Code section 9203, the Agency shall retain no less than five percent (5%) of the compensation to be paid to Contractor which shall be released to the Contractor no later than sixty (60) days from the date of the Contractor's acceptance of the work pursuant to this Agreement.
- JJ. Stop Payment Notice Withholdings. The Agency may withhold payments to cover claims filed under Civil Code § 9350 et seq.
- KK. Restrictions on CSD/City Employees. The Contractor shall not employ any CSD or City employee or official in the work performed pursuant to this Agreement. No officer or employee of the CSD or City shall have any financial interest in this Agreement in violation of federal, state, or local law.
- LL. Choice of Law and Venue. The laws of the State of California shall govern the rights, obligations, duties, and liabilities of the parties to this Agreement, and shall govern the interpretation of this Agreement. Any legal proceeding arising from this Agreement shall be brought in the appropriate court located in Riverside County, State of California.
- MM. Legal Action.

3. Should either party bring any legal or equitable action for the purpose of protecting or enforcing its rights under this Agreement, the prevailing party in such action shall recover in addition to all other relief, its reasonable attorney's fees and court costs, fixed by the court.

4. In addition to the foregoing award of attorney's fees, the prevailing party shall be entitled to its attorneys' fees incurred in any post judgement proceedings to enforce any judgments in connection with this Agreement. The provision is separate and several and shall survive the merger of this provision into any judgement.

NN. Warranty.

1. The Contractor, the Contractor's heirs, executors, administrators, successors, and/or assigns guarantee that all work performed under this Agreement fully meets the requirements thereof as to quality of workmanship and materials furnished, including without limitation materials to be of good quality and fit for their purpose and intended use. If any defects in materials or workmanship become evident prior to expiration of the term of this Agreement or release of the Performance Bond, whichever occurs first, the Contractor shall, at his or her own expense, make any repair(s) or replacement(s) necessary to restore the work to full compliance with the plans and specifications. Contractor shall also repair, replace and restore any other work which is displaced in correcting defective work which the Agency by reason of such defects reasonably suspects may also be defective. In the event of a failure to commence with the compliance of above-mentioned requirements within seven (7) calendar days after being notified in writing of failure to diligently pursue such compliance to completion, the Agency is hereby authorized to proceed to have the defects repaired and made good at the expense of Contractor who hereby agrees to pay the cost and charges therefor immediately on demand.

2. If, in the opinion of the Agency, nonconforming work creates a dangerous condition or requires immediate correction or repair to prevent further loss to the Agency or to prevent interruption of operations, the Agency shall attempt to give the Contractor notice of the same. If Contractor cannot be contacted or does not comply with the Agency's request for correction within a reasonable time as determined by the Agency, the Agency may proceed to make such correction or provide such repair. The costs of such correction or repair shall be charged against Contractor, who agrees to make payment for said costs upon demand. Corrective action by the Agency will not relieve Contractor or Contractor's sureties or insurers of the guarantees and indemnities of this Agreement.

3. This section does not in any way limit the Agency's remedies available under the law, or the guarantee on any items for which a longer guarantee is specified or on any items for which a manufacturer or supplier gives a longer guarantee period. Contractor agrees to act as a co-guarantor with such manufacturer or supplier and shall furnish the Agency all appropriate guarantees or warranty certificates upon completion of the Project. No manufacturer's guarantee period shall in any way limit the liability of Contractor or Contractor's sureties and insurers under the indemnity or insurance provisions of this Agreement.

OO. Records. The Contractor agrees that he or she and its subcontractors shall maintain and keep books, payrolls, invoices of materials, and records on a current basis, and recordings of all transactions pertaining to this Agreement in a form in accordance with generally acceptable accounting principles. Said books and records shall be made available to the City, the CSD, County of Riverside, the State of California, the federal government and to any authorized representative thereof for purposes of audit and inspection at all reasonable times and places. All such books, payrolls, invoices of materials, and records shall be retained for such periods of time as required by law, provided, however, notwithstanding any shorter period of retention, all books, records,

and supporting detail shall be retained for a period of at least three (3) years after acceptance of the Project by the Agency.

PP. Performance. The parties do for themselves, their heirs, executors, administrators, successors and assigns agree to the full performance of all of the provisions herein contained. The Contractor may not, either voluntarily or by action of law, assign any obligation assumed by the Contractor hereunder without prior written consent of the CSD Board.

QQ. Workers' Compensation. By my signature hereunder, as Contractor, I certify that I am aware of the provisions of Section 3700 of the Labor Code which require every employer to be insured against liability for Workers' Compensation or to undertake self-insurance in accordance with the provisions of that code, and I will comply with such provisions before commencing the performance of the work of this Agreement. Contractor agrees to waive its statutory immunity under any workers' compensation or similar statute, as respecting the Agency, and to require any and all subcontractors and any other person or entity involved in the Project to do the same.

RR. Independent Contractor Waiver and Civil Code Section 1542 Waiver. Contractor expressly waives any claims for any compensation or benefits afforded to CSD and/or City employees and not to independent contractors, and waives any and all rights and benefits conferred upon it by the provisions of section 1542 of the California Civil Code which reads as follows:

“A general release does not extend to claims which the creditor does not know or suspect to exist in his or her favor at the time of executing the release, which if known by him or her must have materially affected his or her settlement with the debtor.”

This waiver shall be effective as a bar to any and all actions, fees, damages, losses, claims, liabilities and demands of whatsoever character, nature and kind that are known or unknown, or suspected or unsuspected, including, without limitation, claims of entitlements under the California Public Employees' Retirement System (CalPERS) that are only afforded to employees and not independent contractors. Contractor further represents and warrants that it understands this waiver and that if it does not understand this waiver, it shall seek the advice of a qualified attorney before executing this Agreement.

Initials

SS. Acceptance of Work. Acceptance of the work shall be by action of the Agency's CSD Board or its designee. Neither the acceptance nor prior inspections or failure to inspect shall constitute a waiver by the Agency of any defects in the work. From and after acceptance, the work shall be owned and operated by the Agency. As a condition to acceptance, Contractor shall certify to the Agency in writing that all of the work has been performed in strict conformity with this Agreement and that all costs have been paid, satisfactorily to the Agency, guaranteeing such performance.

TT. Licensing. Contractors are required by law to be licensed and regulated by the Contractors' State License Board. Any questions concerning a Contractor may be referred to the Registrar, Contractors' State License Board, 3132 Bradshaw Road, Sacramento, CA 95826. Mailing address: P.O.Box 26000, Sacramento, CA 95826.

UU. City of Moreno Valley Business License. The Contractor and all subcontractors shall obtain and keep current a valid City of Moreno Valley Business License and all professional licenses, certifications and/or permits necessary for performing the services

Attachment: KASA Construction Inc - Public Works Construction Agreement - JFK RENO (2845 : APPROVE AND EXECUTE AGREEMENT FOR

describe in this Agreement prior to commencement and throughout the term of this Agreement.

VV. Default.

1. Failure or delay by any party to this Agreement to perform any material term or provision of this Agreement shall constitute a default under this Agreement; provided however, that if the party who is otherwise claimed to be in default by the other party commences to cure, correct or remedy the alleged default within fifteen (15) days after receipt of written notice specifying such default and diligently completes such cure, correction or remedy, such party shall not be deemed to be in default hereunder.

2. The party which may claim that a default has occurred shall give written notice of default to the party in default, specifying the alleged default. Delay in giving such notice shall not constitute a waiver of any default nor shall it change the time of default; provided, however, the injured party shall have no right to exercise any remedy for a default hereunder without delivering the written default notice, as specified herein.

3. Any failure or delay by a party in asserting any of its rights or remedies as to any default shall not operate as a waiver of any default or of any rights or remedies associated with a default.

4. In the event that a default of any party to this Agreement may remain uncured for more than fifteen (15) days following written notice, as provided above, a "breach" shall be deemed to have occurred. In the event of a breach, the injured party shall be entitled to seek any appropriate remedy or damages by initiating legal proceedings.

WW. Cumulative Remedies. Except with respect to rights and remedies expressly declared to be exclusive in this Agreement, the rights and remedies of the parties are cumulative and the exercise by either party of one or more of such rights or remedies shall not preclude the exercise by it, at the same or different times, of any other rights or remedies for the same default of any other default by the other party.

XX. Conflicts of Interest. Contractor covenants that it does not have any interest, nor shall it acquire an interest, directly or indirectly, which would conflict in any manner with the performance of Contractor's services under this Agreement. In the event the Agency officially determines that Contractor must disclose its financial interests by completing and filing a Fair Political Practices Commission Form 700, Statement of Economic Interests, Contractor shall file the subject Form 700 with City Hall, as specified under the Notice provisions of this Agreement, pursuant to the written instructions provided by the Agency.

YY. Delivery of Notices. All notices permitted or required under this Agreement shall be given to the respective parties at the following address, or at such other address as the respective parties may provide in writing for this purpose:

Contractor:

**KASA Construction Inc.
15148 Sierra Bonita Lane
Chino, CA 91710
Business Phone: 951.606.8056
Attn: Hector Zavala
Email: Hectorz@kasaconstruction.com**

**Agency:
Parks and Community Services
14075 Frederick St
Post Office Box 88005
Moreno Valley, CA 92552-0805
Attn: Tony Hetherman**

- Such notice shall be deemed made when personally delivered or when mailed, forty-eight (48) hours after deposit in the U.S. Mail, first class postage prepaid and addressed to the party at its applicable address. Actual notice shall be deemed adequate notice on the date actual notice occurred, regardless of the method of service.
- ZZ. Time of Essence. Time is of the essence for each and every provision of this Agreement.
- AAA. Agency's Right to Employ Other Contractors.
1. The Agency reserves the right to employ other contractors in connection with work ancillary to the Project. The Contractor shall be responsible for ascertaining the nature and extent of any simultaneous, collateral, and essential work by others and coordinating with the work by others. The Agency, other contractors and utilities shall have the right to operate within or adjacent to the Project site during the performance of such work.
 2. Should construction be under way by other forces or by other contractors within or adjacent to the limits of the work specified or should work of any other nature be under way by other forces within or adjacent to those limits, the Contractor shall cooperate with all the other contractors or other forces to the end that any delay or hindrance to their work will be avoided. The right is reserved to perform other or additional work at or near the site (including material sources) at any time, by the use of other forces.
- BBB. Amendment; Modification. No supplement, modification, or amendment of this Agreement shall be binding unless executed in writing and signed by both parties.
- CCC. Waiver. No waiver of any default shall constitute a waiver of any other default or breach, whether of the same or other covenant or condition. No waiver, benefit, privilege, or service voluntarily given or performed by a party shall give the other party any contractual rights by custom, estoppel, or otherwise.
- DDD. No Third Party Beneficiaries. There are no intended third party beneficiaries of any right or obligation assumed by the parties, nor shall any provision of this Agreement be so construed.
- EEE. Counterparts. This Agreement may be signed in counterparts, each of which shall constitute an original. All electronic signatures shall be deemed to be one and the same as original signatures.
- FFF. Invalidity; Severability. If any portion of this Agreement is declared invalid, illegal, or otherwise unenforceable by a court of competent jurisdiction, the remaining provisions shall continue in full force and effect; and, to the extent permitted and possible, the invalid or unenforceable term shall be deemed replaced by a term that comes closest to expressing the intention of such invalid or unenforceable term.
- GGG. Assignment or Transfer. Contractor shall not assign, hypothecate, or transfer, either directly or by operation of law, this Agreement or any interest herein without the prior written consent of the Agency. Any attempt to do so shall be null and void, and any assignees, hypothecates or transferees shall acquire no right or interest by reason of such attempted assignment, hypothecation or transfer.
- HHH. Bonds (applicable when Project exceeds \$25,000.00), (Exhibit C)
1. Performance Bond. The Contractor shall furnish a satisfactory Performance Bond meeting all statutory requirements of the State of California on the form provided by the Agency. The bond shall be furnished as a guarantee of the faithful performance of the requirements of this Agreement as may be amended from time to time, including, but not limited to, for protection against liability for delays and damages (both direct and consequential) to the Agency and the Agency's consultants and other contractors, and to ensure all warranties, guarantees, and indemnity obligations, in an amount that shall remain equal to one hundred percent (100%) of the compensation to be paid Contractor under this Agreement. The Performance Bond shall remain in force until at least two (2)

years after the date of final acceptance of the Project, unless the City determines, in its sole and absolute discretion, to release the Performance Bond earlier and notifies Contractor in writing.

2. Labor and Materials Payment Bond. The Contractor shall furnish a satisfactory Labor and Materials Payment Bond meeting all statutory requirements of the State of California on the form provided by the Agency in an amount that shall remain equal to one hundred percent (100%) of the compensation to be paid Contractor under this Agreement to secure payment of all claims, demands, stop notices, or charges of material suppliers, mechanics, or laborers employed by the Contractor or by any subcontractor, or any person, firm, or entity eligible to file a stop payment notice with respect to the Project. The Labor and Materials Payment Bond shall remain in force and shall not be released until at least seven (7) months after the date of recordation of the Notice of Completion or Notice of Acceptance, whichever occurs first.

3. Bond Requirements.

a. All bonds shall be executed by a California-admitted surety insurer. Bonds issued by a California-admitted surety insurer listed on the latest version of the U.S Department of Treasury Circular 570 shall be deemed accepted unless specifically rejected by the Agency. Bonds issued by sureties not listed in Treasury Circular 570 must be accompanied by all documents enumerated in California Code of Civil Procedure Section 995.660(a). The bonds shall bear the same date as the Agreement. The attorney-in-fact who executes the required bonds on behalf of the surety shall affix thereto a certified and current copy of the power of attorney. In the event of changes that increase the Agreement compensation, the amount of each bond shall be deemed to increase and at all times remain equal to the Agreement amount. The signatures shall be acknowledged by a notary public. Every bond must display the surety's bond number and incorporate by reference the Agreement and the obligations to complete the Project in accordance with the Agreement. The terms of the bonds shall provide that the surety agrees that no change, extension of time, alteration, or modification of the Agreement or the work to be performed thereunder shall in any way affect its obligations and shall waive notice of any such change, extension of time, alteration, or modification of the Agreement. The surety further agrees that it is obligated under the bonds to any successor, grantee, or assignee of the Agency.

b. Upon the request of any person or entity appearing to be a potential beneficiary of bonds covering payment of obligations arising under the Agreement, the Contractor shall promptly furnish a copy of the bonds or shall authorize a copy to be furnished.

c. Should any bond become insufficient, or should any of the sureties, in the opinion of the Agency, become non-responsible or unacceptable, the Contractor shall, within ten (10) calendar days after receiving notice from the Agency, provide written documentation to the satisfaction of the Agency that Contractor has secured new or additional sureties for the bonds; otherwise the Contractor shall be in default of the Agreement. No further payments shall be deemed due or will be made under the Agreement until a new surety(ies) qualifies and is accepted by the Agency.

III. Non-Liability of City or CSD's Officers and Employees. No officer or employee of the City or CSD shall be personally liable to Consultant, or any successor in interest, in the event of any default or breach by the Agency or for any amount which may become due to Consultant or to its successor, or for any breach of any obligation of the terms of this Agreement.

SIGNATURE PAGE TO FOLLOW

IN WITNESS HEREOF, the parties have each caused their authorized representative to execute this Agreement.

Moreno Valley Community Services District

KASA Construction Inc.

By: _____
Executive Director

By: _____

Title: _____

Date: _____

Date: _____

By: _____

Title: _____

Date: _____

INTERNAL USE ONLY

APPROVED AS TO LEGAL FORM:

City Attorney

Date

RECOMMENDED FOR APPROVAL:

Parks & Community Services Director

Date

RECOMMENDED FOR APPROVAL:

Parks Projects Coordinator

Date

Signature(s) must be accompanied by a completed notary certificate of acknowledgement attached hereto. **Two (2)** corporate officers must sign on behalf of a corporation unless the corporation has a corporate resolution that allows one person to sign on behalf of the corporation; if applicable, said resolution must be attached hereto. The corporate seal may be affixed hereto. The contract shall be notarized

Attachments

- Exhibit A: Agency – Services to be provided to Contractor
- Exhibit B: Terms of Payment
- Exhibit C: Bond Forms
- Exhibit D: Bid Documents, Addenda, Special Provisions

Attachment: KASA Construction Inc - Public Works Construction Agreement - JFK RENO (2845 : APPROVE AND EXECUTE AGREEMENT FOR

EXHIBIT A
SERVICES TO BE PROVIDED
TO CONTRACTOR

1. Furnish the Contractor all in-house data which is pertinent to services to be performed by the Contractor and which is within the custody or control of the Agency, including, but not limited to, copies of record and off-record maps and other record and off-record property data, right-of-way maps and other right-of-way data, pending or proposed subject property land division and development application data, all newly developed and pertinent design and project specification data, and such other pertinent data which may become available to the Agency.
2. Provide timely review, processing, and reasonably expeditious approval of all submittals by the Contractor.
3. Provide timely Agency staff liaison with the Contractor when requested and when reasonably needed.

Attachment: KASA Construction Inc - Public Works Construction Agreement - JFK RENO (2845 : APPROVE AND EXECUTE AGREEMENT FOR

EXHIBIT B**TERMS OF PAYMENT**

1. The Agency will pay the Contractor and the Contractor agrees to receive and accept the prices set forth in the Bid Schedule as full compensation for the work required under the bid items awarded by the Agency, to wit, the **Base Bid Item(s)** in the sum total amount of **five hundred sixty-six thousand, five hundred, twenty-five and 00/100 dollars (\$566,525.00)**, subject to additions or reductions of the quantities of the various bid items at the unit prices bid, for furnishing all materials and for doing all the work contemplated and embraced under this Agreement; for all loss or damages arising out of the nature of the work aforesaid, or from the action of the elements, or from any unforeseen difficulties or obstructions which may arise or be encountered in the prosecution of the work, until the work is accepted by the Board of Directors; for all expenses incurred by or in consequence of the suspension or discontinuance of work; and for well and faithfully completing the work, the whole thereof, in the manner and in accordance with the Bid Documents therefore and the requirements of the Engineer under them.
2. A contingency of seventy thousand and 00/100 dollars (\$70,000.00) is added to the project's base bid. The contingency shall only be utilized with approval of the Director or his/her designee for items foreseen and/or unforeseen that have been added to the project by the Agency. All requests shall be documented in writing. (ONLY IF THERE IS A CONTINGENCY)
3. The Contractor will obtain, and keep current during the term of this Agreement, the required City of Moreno Valley business license. Proof of a current City of Moreno Valley business license will be required prior to any payments by the Agency. Any invoice not paid because the proof of a current City of Moreno Valley business license has not been provided will not incur any fees, late charges, or other penalties. Complete instructions for obtaining a City of Moreno Valley business license are located at: http://www.moval.org/do_biz/biz-license.shtml
4. The Contractor shall meet with the Director or his/her designee monthly, prior to billing, to review and agree on quantities and work performed.
5. The Contractor will electronically submit an invoice to the Agency as provided in this Agreement for progress payments along with documentation evidencing services completed to date. The progress payment is based on actual time and materials expended in furnishing authorized professional services since the last invoice. At no time will the Agency pay for more services than have been satisfactorily completed and the Agency determination of the amount due for any progress payment shall be final. The Contractor will submit all original invoices to Accounts Payable staff at AccountsPayable@moval.org and to Tony Hetherman at tonyh@moval.org.
6. Accounts Payable questions can be directed to 951.413.3087.
7. Questions regarding invoicing, quantities, and/or labor can be directed to Tony Hetherman at 951.413.3163.
8. The Contractor agrees that Agency payments will be received via Automated Clearing House (ACH) Direct Deposit and that the required ACH Authorization form will be completed prior to any payments by the Agency. Any invoice not paid because the completed ACH Authorization Form has not been provided will not incur any fees, late charges, or other penalties. The ACH Authorization Form is located at: http://www.moval.org/city_hall/forms.shtml#bf

- 9. The minimum information required on all invoices is:
 - A. Vendor Name, Mailing Address, and Phone Number
 - B. Invoice Date
 - C. Vendor Invoice Number
 - D. City-provided Reference Number (e.g. Project, Activity, and Purchase Order No.)
 - E. Detailed work hours by class title (e.g. Manager, Technician, or Specialist), services performed and rates, explicit portion of a contract amount, or detailed billing information that is sufficient to justify the invoice amount; single, lump amounts without detail are not acceptable.

- 10. The Agency shall pay the Contractor for all invoiced, authorized professional services within thirty (30) days of receipt of the invoice for same, provided the services reflected in the invoice were performed to the reasonable satisfaction of the Agency in accordance with the terms of this Agreement.

- 11. Pursuant to Public Contract Code section 9203, the Agency shall retain no less than five (5) percent of the compensation to be paid to Contractor which shall be released to the Contractor no later than sixty (60) days from the date of the Agency's acceptance of the work pursuant to this Agreement.

Attachment: KASA Construction Inc - Public Works Construction Agreement - JFK RENO (2845 : APPROVE AND EXECUTE AGREEMENT FOR

EXHIBIT C
BONDS

Attachment: KASA Construction Inc - Public Works Construction Agreement - JFK RENO (2845 : APPROVE AND EXECUTE AGREEMENT FOR

BOND NO. _____

**FAITHFUL PERFORMANCE BOND
(100% of Total Contract Price)**

**Moreno Valley Community Services District of the City of Moreno Valley
JOHN F. KENNEDY VETERANS MEMORIAL PARK
RESTROOM IMPROVEMENTS
PROJECT NO. PCS HSG GR - JFK RENO**

KNOW ALL MEN AND WOMEN BY THESE PRESENTS:

THAT WHEREAS, the Moreno Valley Community Services District of the City of Moreno Valley, County of Riverside, State of California, known as "CSD," has awarded to [KASA Construction Inc.](#), as Principal hereinafter designated as "Contractor" and have entered into an Agreement whereby the Contractor agrees to construct or install and complete certain designated public improvements, which said Agreement, effective on the date signed by the [Executive Director](#), and identified as [Project No. PCS HSG GR - JFK RENO](#), and all Contract Documents are hereby referred to and made a part hereof; and

WHEREAS, said Contractor under the terms of said Contract Documents is required to furnish a bond guaranteeing the faithful performance of said Agreement;

NOW THEREFORE, we the undersigned Contractor and _____ as Surety are held and firmly bound unto the Moreno Valley Community Services District of the City of Moreno Valley, County of Riverside in the penal sum of **five hundred sixty-six thousand, five hundred, twenty-five and 00/100 dollars (\$566,525.00)**, lawful money of the United States, to be paid to the said CSD or its certain attorney, its successors and assigns; for which payment, well and truly to be made, we bind ourselves, our heirs, executors and administrators, successors and assigns, jointly and severally liable (CCP 995.320 (a)(1)), firmly by these presents.

THE CONDITION OF THIS OBLIGATION IS SUCH, that if the above bound Contractor, his or her or its heirs, executors, administrators, successors or assigns, shall in all things stand to and abide by, and well and truly keep and perform the covenants, conditions and provisions in said Contract Documents and any alterations thereof made as therein provided, on his or her or their part, to be kept and performed at the time and in the manner therein specified, and in all respects according to their true intent and meaning, and shall indemnify and save harmless the CSD, its officers, agents and employees, as therein stipulated, then this obligation shall become null and void; otherwise it shall be and remain in full force and effect. In the event suit is brought upon this bond by the CSD and judgement is recovered, the Surety shall pay all costs incurred by the CSD in such suit, including a reasonable attorney fee to be fixed by the court.

The Surety hereby stipulates and agrees that no change, extension of time, alteration, or addition to the terms of the Contract Documents or to the Work to be performed thereunder, or the Provisions accompanying the same shall in any way affect its obligations on this bond, and it does hereby waive notice of any such change, extension of time, alteration or addition to the terms of the Contract Documents or to the Work or the Provisions.

(SIGNATURE PAGE FOLLOWS)

Attachment: KASA Construction Inc - Public Works Construction Agreement - JFK RENO (2845 : APPROVE AND EXECUTE AGREEMENT FOR

BOND NO. _____

IN WITNESS WHEREOF, we have hereunto set our hands and seals on this _____ day of _____ 20_____.

CONTRACTOR (Principal)

SURETY

Contractor Name: _____

Name: _____

Address: _____

Address: _____

Telephone No.: _____

Telephone No.: _____

Print Name: _____

Print Name: _____
Attorney-in-Fact

Signature: _____

Signature: _____

Approved as to Form this

_____ day of _____ 20_____

City Attorney
City of Moreno Valley

NOTE:

- The bond shall be executed by a California admitted surety insurer (CCP 995.311).
- The bond shall include an attached Notary Certificate for the Attorney-in-Fact.
- The bond shall include an attached Notary Certificate for the Contractor.
- The bond shall include an attached original Power of Attorney only authorizing the Attorney-in-Fact to act for the Surety.
- The bond shall include the address at which the Principal (Contractor) and Surety may be served with notices, papers and other documents.
- The Bidder's and Surety's corporate seal may be affixed hereto.

BOND NO. _____

**LABOR AND MATERIALS PAYMENT BOND
(100% of Total Contract Amount)**

**Moreno Valley Community Services District of the City of Moreno Valley
JOHN F. KENNEDY VETERANS MEMORIAL PARK
RESTROOM IMPROVEMENTS
PROJECT NO. PCS HSG GR - JFK RENO**

KNOW ALL MEN AND WOMEN BY THESE PRESENTS

THAT WHEREAS, the Moreno Valley Community Services District of the City of Moreno Valley, County of Riverside, State of California, known as "CSD," has awarded to [KASA Construction Inc.](#), as Principal hereinafter designated as "Contractor" and have entered into an Agreement whereby the Contractor agrees to construct or install and complete certain designated public improvements, which said Agreement, effective on the date signed by the [Executive Director](#), and identified as [Project No. PCS HSG GR - JFK RENO](#), and all Contract Documents are hereby referred to and made a part hereof; and

WHEREAS, said Contractor under the terms of said Contract Documents is required to furnish a bond to secure the payment of claims of laborers, mechanics, materialmen, and other persons, as provided by law;

NOW THEREFORE, we the undersigned Contractor and _____ as Surety are held and firmly bound unto the Moreno Valley Community Services District of the City of Moreno Valley, County of Riverside in the penal sum of **five hundred sixty-six thousand, five hundred, twenty-five and 00/100 dollars (\$566,525.00)** lawful money of the United States, to be paid to the said CSD or its certain attorney, its successors and assigns; for which payment, well and truly to be made, we bind ourselves, our heirs, executors and administrators, successors and assigns, jointly and severally liable (CCP 995.320 (a)(1)), firmly by these presents.

THE CONDITION OF THIS OBLIGATION IS SUCH, that if said Contractor, his or her or its heirs, executors, administrator, successors or assigns, or subcontractors, shall fail to pay any of the persons described in the State of California Civil Code, Section 3181, or amounts due under the Unemployment Insurance Code with respect to work or labor performed by any such claimant, or any amounts required to be deducted, withheld, and paid over to the Franchise Tax Board from the wages of employees of the Contractor and his or her subcontractors, pursuant to Section 13020, of the Unemployment Insurance Code, with respect to such work and labor, that the Surety or Sureties herein will pay for the same in an amount not exceeding the sum specified in this bond, otherwise the above obligation shall be void. In the event suit is brought upon this bond by the CSD or other person entitled to bring such an action and judgement is recovered, the Surety shall pay all costs incurred by the CSD in such suit, including a reasonable attorney fee to be fixed by the court.

This bond shall inure to the benefit of any of the persons described in the State of California Civil Code Section 3181, to give a right of action to such persons or their assigns in any suit brought upon this bond.

(SIGNATURE PAGE FOLLOWS)

Attachment: KASA Construction Inc - Public Works Construction Agreement - JFK RENO (2845 : APPROVE AND EXECUTE AGREEMENT FOR

BOND NO. _____

IN WITNESS WHEREOF, we have hereunto set our hands and seals on this _____ day of _____ 20____.

CONTRACTOR (Principal)

SURETY

Contractor Name: _____

Name: _____

Address: _____

Address: _____

Telephone No.: _____

Telephone No.: _____

Print Name: _____

Print Name: _____

Attorney-in-Fact

Signature: _____

Signature: _____

Approved as to Form this

_____ day of _____ 20____

City Attorney
City of Moreno Valley

NOTE:

- The bond shall be executed by a California admitted surety insurer (CCP 995.311).
- The bond shall include an attached Notary Certificate for the Attorney-in-Fact.
- The bond shall include an attached Notary Certificate for the Contractor.
- The bond shall include an attached original Power of Attorney only authorizing the Attorney-in-Fact to act for the Surety.
- The bond shall include the address at which the Principal (Contractor) and Surety may be served with notices, papers and other documents.
- The Bidder's and Surety's corporate seal may be affixed hereto.



**CITY OF MORENO VALLEY
PARKS AND COMMUNITY SERVICES DEPARTMENT**

Bid No. 2018-008

**JOHN F. KENNEDY
VETERANS MEMORIAL PARK –
RESTROOM IMPROVEMENTS
15115 Indian St., Moreno Valley, CA 92553**

October 27th, 2017

Attachment: Request for Bid PCS HSG GR-JFK RENO_AD FINAL PB (2845 : APPROVE AND EXECUTE AGREEMENT FOR THE INSTALLATION

TABLE OF CONTENTS

| <u>Title</u> | <u>Page</u> |
|--|-----------------------------|
| <u>Table of Contents</u> | <u>2</u> |
| <u>Preamble</u> | <u>3</u> |
| <u>Notice Inviting Bids</u> | <u>4-9</u> |
| <u>Instruction to Bidders</u> | <u>10-17</u> |
| <u>Bidder's Proposal</u> | <u>18-21</u> |
| <u>Bid Bond</u> | <u>22-23</u> |
| <u>California All-Purpose Certificate of Acknowledgment (Sample)</u> | <u>24</u> |
| <u>Contractor's Statement</u> | <u>25-35</u> |
| <u>Separate Documents</u> | |
| <u>Sample Bid Documents</u> | <u>1 – 25</u> |
| <u>Special Provisions - General</u> | <u>0701-1 – 0701-79</u> |
| <u>Special Provisions - Technical</u> | <u>0702-80 – 0702-142</u> |
| <u>Special Provisions - Appendices</u> | <u>0800-143 – 0800-172</u> |
| <u>Project Plans and Related Documents</u> | <u></u> |

Bid No. 2018-008

BID DOCUMENTS

Bid No. 2018-008

For

**JOHN F. KENNEDY
VETERANS MEMORIAL PARK –
RESTROOM IMPROVEMENTS
27891 JFK Drive, Moreno Valley, CA**

PREAMBLE

The City Special Provisions contained herein supplement and/or modify the General Provisions and Technical Provisions of the Standard Specifications for Public Works Construction (“Greenbook”) latest edition. The City Special Provisions are arranged in accordance with the numbering format used in the Standard Specifications, with subsections added where necessary.

Each and every provision of law required to be inserted in the Bidding Documents shall be deemed to be inserted therein, and the Bidding Documents shall be read and enforced as though it were included therein.

Bid No. 2018-008

NOTICE INVITING BIDS

NOTICE IS HEREBY GIVEN THAT THE CITY OF MORENO VALLEY hereinafter referred to as "the City" or "City," will receive electronic bids **prior to** the Bid Deadline established below, for the Contract for construction of the Work generally described as:

**JOHN F. KENNEDY
VETERANS MEMORIAL PARK –
RESTROOM IMPROVEMENTS
15115 Indian St, Moreno Valley, CA 92553**

Place for Receipt of Bids: Bids shall be received electronically only on the City of Moreno Valley Bid Portal through PlanetBids. The link to register to become a prospective bidder and electronically bid on this project can be found at the following address: <http://www.planetbids.com/portal/portal.cfm?CompanyID=24660>

Pre-Submittal Meeting: A pre-submittal meeting will be held on **Wednesday Nov. 08, 2017 @ 10:00 a.m., PST** located at 15115 Indian St., Moreno Valley, CA 92551.

Companies wishing to submit a bid for this project are strongly encouraged to attend.

Requests for Information Deadline: Date/Time: **Nov. 14, 2017 before 2:00 p.m., PST**

All requests for information must be submitted via the City of Moreno Valley Bid Portal through PlanetBids. Any RFI received after the date and time specified herein will not be considered.

Bid Deadline: **Nov. 21, 2017 before 4:00 p.m., PST**

Bid No. 2018-008

1. **Date of Commencement and Time for Completion:** The Contractor shall complete all preconstruction requirements, ordering of materials, and construction of the Project within the Contract Time of **One Hundred, Ten (110) Working Days** after the date of commencement specified in the Notice to Proceed to Fulfill Preconstruction Requirements and Notice to Proceed with Order of Materials issued by the City. See **Paragraph 2H** of the Agreement for details regarding the initial Notice to Proceed to Fulfill Preconstruction Requirements and Notice to Proceed with Order of Materials and subsequent Notice to Proceed with Construction.
2. **Bidder Information and Addenda:** Each Bidder shall register to become a prospective bidder via the City of Moreno Valley Bid Portal through PlanetBids; Addenda, if any, shall be issued via email through the PlanetBids Bid Portal. It is the Contractor's responsibility to ensure the email utilized in the Portal is current and accurate and it is further the Contractor's responsibility to actively check the Portal and email for the issuance of Addenda. The City reserves the right to extend the Bid Deadline and Bid Opening by issuing an Addendum to Bidders no later than 72 hours prior to the Bid Deadline.
3. **Bid Forms:** Bids shall be made upon the electronic proposal form online from the City of Moreno Valley Vendor Portal through PlanetBids at the above referenced address. Paper copies will not be accepted. The Bid Sheet included in the proposal is provided for reference and defines the basis of bid. The unit prices for each bid item shall be properly entered in the online electronic proposal.

Each Bidder must scan and submit the following documents with its electronic bid on the City's Bidder's Proposal forms:

- a. Contractor's Statement
- b. Bid Bond at Ten Percent (10%) of the Total Bid Price

The bidder may utilize a cashier's or certified check in lieu of a bid bond in the amount of ten percent (10%) of the total bid. If a cashier's or certified check is used, it shall be delivered to the City Clerk in a sealed envelope at 14177 Frederick Street, Moreno Valley, CA 92553 prior to the bid deadline specified herein.

If any Bidder makes any alteration, or otherwise deviates from any of the pre-defined Bidder's Proposal forms, or makes any qualifications of the Bidder's Proposal forms in separate documents submitted with the Bidder's Proposal, the Bid may be considered non-responsive. All Bidders' Proposals shall be evaluated on the basis of the Engineer's estimate of the quantities of Work to be performed.

4. **Bid Security:** Each Bid shall be accompanied by Bid Security, in the form of a certified check, cashier's check, or Bidder's Bond executed by a California-admitted surety insurer (as defined by California Code of Civil Procedure §§ 995.120 and 995.311) in an amount of not less than **ten percent (10%)** of the amount of the total Bid price. Such Bid Security shall guarantee that the Bidder, if his or her Proposal is accepted, will execute the Agreement, secure and furnish proof of Commercial General Liability, Automobile, and Workers' Compensation Insurance as required by the Contract Documents, furnish a Faithful Performance Bond in the amount of one hundred percent (100%) of the total Contract Price, and furnish a Labor and Materials Payment Bond in the amount of one hundred percent (100%) of the total Contract Price, within ten (10) Working Days after the date of the receipt of the Agreement. Failure to execute and furnish said Contract Documents within said 10 days shall be just cause for the annulment of the award and forfeiture of the Bid Security pursuant to the provisions of Section 20172 of the California Public Contract Code. The City will request the

Bid No. 2018-008

original bid bonds of the three lowest bidders to be provided to the City within 72 hours of the bid deadline and shall retain the Bid Security of the first, second, and third lowest responsible Bidders until such time as the Agreement is executed. The Bid Security submitted by all other Bidders will be released within thirty (30) days after the date of the award of the Contract. Submission of the bid security shall be in accordance with the instructions provided in Paragraph 3, "Bid Forms", contained herein.

- 5. Contractor Registration:** California law (SB854) provides that "A contractor or subcontractor shall not be qualified to bid on, be listed in a bid proposal, subject to the requirements of section 4104 of the Public Contract Code, or engage in the performance of any contract for public work, as defined in this chapter, unless currently registered and qualified to perform work pursuant to Labor Code section 1725.5." Please go to <http://www.dir.ca.gov/Public-Works/PublicWorks.html>, and look under "Contractor Registration" for more information and to register. Pursuant to the above law, no contractor or subcontractor may be listed on a bid proposal for a public works project (submitted on or after April 1, 2015) unless registered with the Department of Industrial Relations pursuant to Labor Code section 1725.5 [with limited exceptions from this requirement for bid purposes only under Labor Code section 1771.1(a)]. Additionally, no contractor or subcontractor may be awarded a contract for public work on a public works project (awarded on or after April 1, 2015) unless registered with the Department of Industrial Relations pursuant to Labor Code section 1725.5. Please go to <https://www.dir.ca.gov/public-works/publicworkssb854faq.html>

This project is also subject to compliance monitoring and enforcement by the Department of Industrial Relations. All contractors and subcontractors must furnish electronic certified payroll records directly to the Labor Commissioner (aka Division of Labor Standards Enforcement). **For all new projects awarded on or after April 1, 2015, the contractors and subcontractors must furnish electronic certified payroll records to the Labor Commissioner.** As of January 1, 2016: **all contractors (except those listed as Exemptions by the DIR) must furnish electronic certified payroll records to the Labor Commissioner in the "eCPR data system".**

The City of Moreno Valley will not accept a bid nor will it contract or subcontract without proof of the contractor or subcontractor's current registration to perform public works pursuant to section 1725.5.

- 6. Claim Resolution Procedures:** Section 9204 of Assembly Bill 626 sets forth the following new procedural requirements for claims submitted by a contractor on a public works project:
- a. A contractor must furnish "reasonable documentation to support the claim."
 - b. Upon receipt of a claim, a public entity must "conduct a reasonable review" and provide a written statement to the contractor within 45 days of receipt of the claim.
 - c. For any undisputed portion of a claim, a public entity must make payment within 60 days of the public entity's issuance of the written statement.
 - d. If the contractor disputes the public entity's written statement, or if the public entity fails to respond, the contractor may demand "an informal conference to meet and confer for settlement of the issues in dispute."
 - e. The public entity must schedule the meet and confer conference within 30 days

Bid No. 2018-008

of the demand.

f. Within 10 business days following the meet and confer conference, the public entity must provide a written statement identifying the portion of the claim that remains in dispute. Any payment due on an undisputed portion of the claim must be made within 60 days of the meet and confer conference.

g. After the meet and confer conference, any disputed portion of the claim "shall be submitted to non-binding mediation."

h. If mediation is unsuccessful, the parts of the claim that remain in dispute shall be subject to applicable procedures outside Section 9204 (statutory and contractual).

i. Failure of a public entity to respond to a claim within the time periods described in Section 9204 "shall result in the claim being deemed rejected in its entirety."

- 7. Contractors License and Certifications:** No Bid will be accepted from a Bidder who, at the Bid Deadline, is not fully and properly licensed as a contractor in accordance with Chapter 9 of Division 3 of the California Business and Professions Code (Section 7000 et seq.). At the Bid Deadline, the prime Contractor must hold an active Class "A", sufficient to cover all of the work to be performed by the prime Contractor. Licenses including C-8 (Concrete), Class C-61/D34 license (Prefabricated Equipment), and C27 (Landscaping) are highly desirable and required for subcontractors doing any of this work. Failure of the Bidder to obtain proper and adequate license for award of the Contract shall constitute a failure to execute the Contract and shall result in the forfeiture of the Security of the Bidder (PCC 20103.5). All Subcontractors shall be properly licensed at the Bid Deadline.
- 8. Owner's Rights Reserved:** Within such limits as may be prescribed by law, the City Council of the City of Moreno Valley reserves the right to reject any and all Bids, to accept, reject or waive any variances or informalities in a Bid or in the bidding, or to accept the Bid or Bids that best serve the interests of the City.
- 9. Work Performed by Contractor:** The successful Bidder shall perform, with its own organization, Contract Work amounting to at least 51 percent (51%) of the Contract Price, except that any designated "Specialty Items" may be performed by subcontract and the amount of any such "Specialty Items" may be deducted from the Contract Sum before computing the amount of Work required to be performed by the Contractor. See Subsection 2-3.2, "Self Performance," of the Standard Specifications and City Special Provisions.
- 10. Payment of Prevailing Wage Rates:** This Project is subject to the provisions of Labor Code Section 1720 et seq., and the requirements of Title 8 of the California Code of Regulations Section 16000 et seq., which govern the payment of prevailing wages on public works projects. The Director of the Department of Industrial Relations, State of California (DIR) pursuant to the California Labor Code, has determined the general prevailing rates of wages in the locality in which the Work is to be performed. Said rates are on file with the Capital Projects Division of the City of Moreno Valley and copies will be made available to any interested party on request during regular business hours and are also available on the Internet at the California Department of Industrial Relations website: <http://www.dir.ca.gov/dlsr/DPreWageDetermination.htm>. These rates shall be the minimum wage rates for this project. The Contractor shall post a copy of said rates at the job site throughout the period of work on this project. The Contractor shall see that all employees of

Bid No. 2018-008

both the prime Contractor and subcontractors are being paid rates equal to or greater than the said rates. See **Section 7-2.3** of the **City Special Provisions**.

11. **Substitution of Securities:** Pursuant to California Public Contract Code Section 22300, the Contractor may substitute approved securities for any monies withheld by the City to ensure performance of the Work. At the request and sole expense of the Contractor, securities equivalent to the amount withheld shall be deposited with the City, or with a state or federally chartered bank in California as escrow agent, who shall pay such monies to the Contractor after satisfactory completion of the Contract. Securities eligible for investment under this section shall include those listed in Section 16430 of the Government Code, bank or savings and loan certificates of deposit, interest-bearing demand deposit accounts, and standby letters of credit. The Contractor shall be the beneficial owner of any securities substituted for monies withheld and shall receive any dividends and interest thereon. Alternatively, the Contractor may request that the City, at the expense of the Contractor, make payment of retention earned directly to the escrow agent. Notwithstanding the foregoing, such Contractor shall have thirty (30) Calendar Days following award of the Contract to submit a written request to the City to permit the substitution of securities for retention or payment to an escrow agent; failure to do so shall be deemed a waiver of the right.
12. **City of Moreno Valley Business License:** The Contractor and all Subcontractors shall obtain and keep current a City of Moreno Valley Business License prior to commencement and throughout the duration of the Work.
13. **Withdrawal of Bids:** Bids shall remain open and valid for **sixty (60) days** after the Bid Deadline. Bids may be withdrawn electronically on the PlanetBids Vendor Portal prior to the time set for opening of bids. No bid may be withdrawn or changed after the Bid deadline, except as otherwise provided by law. The lowest Bidder may only request relief of its Bid in accordance with Public Contract Code Section 5100 et seq. Each Bidder agrees by submitting a Bid that its Bid shall remain open, is irrevocable, and may not be modified, withdrawn, or cancelled for a period of at least **sixty (60) Calendar Days** after Bid Deadline.
14. **Contract Award/Alternate Bid Items:** Refer to **Paragraph 19** of the Instructions to Bidders, Award of Contract.
15. **Subcontractors:** Each Bidder shall submit, in the electronic Bid Form provided in the City of Moreno Valley's bid portal a list of Subcontractors to be used on this Project as required by the Subletting and Subcontracting Fair Practices Act, California Public Contract Code section 4100 *et seq.*
16. **Insurance:** All Contractors and Subcontractors must provide the insurance described in **Paragraph 7** of the Agreement.
17. **Performance and Payment Bonds:** Refer to **Paragraph 23** of the Instructions to Bidders.
18. **Technical Information:** For technical information relating to the details of this Project and bidding requirements submit all RFI's via the project Q&A tab within the City of Moreno Valley Vendor Portal in PlanetBids <http://www.planetbids.com/portal/portal.cfm?CompanyID=24660>. Any RFI received after the date and time specified herein will not be considered.

Bid No. 2018-008

The project manager for this project will be:

Tony Hetherman
Parks Projects Coordinator
City of Moreno Valley
Parks and Community Services Department

Bid No. 2018-008

INSTRUCTIONS TO BIDDERS

1. **Scope of Project:** The Contractor shall furnish, to the satisfaction of the Engineer, all labor, materials, tools, equipment, and incidentals, unless otherwise specified, to construct and complete the Work in compliance with the Contract Documents, Technical Specifications, Plans, and any Addenda.
2. **General:** Information contained in these Instructions to Bidders is supplemental to information contained in the Notice Inviting Bids. The meanings of all capitalized terms not defined herein are defined in the Standard Specifications or the City Special Provisions.
3. **Examination of Site and Bidding Documents:** The Bidder, at its sole cost and expense, is required to examine carefully the Bidding Documents and the Project site to become fully acquainted with the conditions affecting the Work. The failure of a Bidder to receive or examine any of the Bidding Documents or to inspect the site shall not relieve such Bidder from any obligation with respect to the Bid, the Contract, or the Work required under the Contract Documents. The City assumes no responsibility or liability to any Bidder for, nor shall the City be bound by, any understandings, oral representations or oral agreements of the City's agents, employees or officers concerning the Contract Documents or the Work made prior to execution of the Contract. By submitting a Bid, Bidder represents: (1) that Bidder has read and understands the Bidding Documents; (2) the Bid is made in compliance with the Bidding Documents and is based upon the labor, materials, equipment, and systems required by the Bidding Documents; (3) that Bidder understands that all labor, materials, equipment, and systems to be furnished for the Work shall be furnished for the prices bid; (4) that it has visited the Project site, familiarized itself with the local conditions under which the Work is to be performed; (5) that it is fully experienced, qualified and competent to perform the Work set forth in the Contract Documents; (6) that it shall not damage or endanger and shall preserve and protect adjacent properties; (7) that it is properly equipped, organized and financed to perform the Work; (8) that it is properly permitted and licensed by the California Contractors State Licensing Board to perform the Work; (9) that it has familiarized itself with all conditions bearing upon transportation, disposal, handling and storage of materials; (10) that it has familiarized itself with the availability of labor, water, electric power, and roads; (11) that it has familiarized itself with uncertainties of weather, or similar physical conditions at the Project site; (12) that it has familiarized itself with the character of equipment and facilities needed preliminary to and during performance of the Work; (13) that it has familiarized itself with the staging and material storage constraints of the Project site and surrounding buildings and will confine its staging and storage operations to approved areas; (14) that it will coordinate its construction activities with the other contractors performing work on the Project site, if any, including, but not limited to, any Separate Contractor retained by the City; and (15) that the Bidder has checked figures set forth in the Bid Schedule and understands that neither the City, nor the Moreno Valley Housing Authority, nor the Moreno Valley Community Services District, nor any officer or employee therefore will be responsible for any misunderstandings, errors, or omissions on the part of the Bidder in submitting its Bid.
4. **Urban Runoff:** The Bidder certifies to the City that he/she has trained his/her employees and Subcontractors, if any, for Urban Runoff management and has included sufficient sums in the Bid Price to cover such costs of said training as stipulated in the most current Regional Water Quality Control Board requirements, including the Municipal Separate Storm Sewer System NPDES Permit. The Contractor is responsible for all clean up and payment of all fines levied as

Bid No. 2018-008

a result of any illegal discharge (as defined in said NPDES permit) occurring as a result of the Contractor's Work and/or operations.

5. **Estimated Quantities:** The estimated quantities set forth in the Bid Schedule are approximate only, and are provided only as a basis for the comparison of Bids. The City does not guarantee, expressly or by implication, that the actual amount of Work will correspond therewith, and reserves the right to increase or decrease the amount of any portion of the Work, or to omit portions of the Work, or delete any Bid Items of Work as may be deemed necessary or advisable by the Engineer. Payment shall be made only for actual quantities of Contract items constructed in accordance with the Contract Documents. See Section 9-3, "Payment," of the Standard Specifications and City Special Provisions.
6. **Interpretation of Bidding Documents:** Discrepancies in and omissions from the Bidding Documents shall, at once, be brought to the attention of the City. If any Bidder contemplating submitting a Bid for the Project is in doubt as to the true meaning of any part of the Bidding Requirements or Contract Documents, or who finds discrepancies, errors or omissions therein or who finds variances in any of the Bidding Documents with Applicable Law, such Bidder may submit a written request for an interpretation or correction thereof to the City via the City's electronic bidding system. All Bidders shall submit such written requests to the City on or before the deadline established in the Notice Inviting Bids unless modified by Addendum (i.e., at least **five (5) Working Days** prior to the Bid Deadline, unless modified by Addendum). Any interpretation or correction will be made only by Addenda duly issued by the City, and a copy of such Addenda will be e-mailed to each Registered Bidder. The City will not be responsible for any other explanations or interpretations. No oral agreement or conversation with any officers, employees, or agents of the City, either before or after execution of the Contract, shall affect or modify any of the terms of obligations contained in any of the Contract Documents.
7. **Addenda:** Before the Bid Deadline, the City may modify the Work, the Bidding Documents, or any portion(s) thereof by the issuance of written Addenda disseminated to all Registered Bidders. All Addenda shall be acknowledged electronically in the Bidder's Proposal submitted within the City's vendor portal and shall become a part of the Contract Documents. The cost of performing Work described in the Addenda shall be included in the Bid. If any Addenda have been issued by the City but are not acknowledged by the Bidder in the Bidder's Proposal, the Bid may be rejected as non-responsive. All Addenda or Bulletins will be issued via email through the Planet Bids Vendor Portal. It is the Contractor's responsibility to ensure the email utilized in the Planet Bids Vendor Portal is current and accurate and it is further the Contractor's responsibility to actively check the email for Addenda or Bulletin updates.
8. **Bid Forms and Submission of Bid:** Bids shall be made upon the electronic proposal online from the City of Moreno Valley Vendor Portal through PlanetBids at the above referenced address. Paper copies will not be accepted. The Bid Sheet included in the proposal is provided for reference and defines the basis of bid. The unit prices for each bid item shall be properly entered in the online electronic proposal.
9. **Bid Schedule:** The Bidder shall set forth for each Bid Item, in the electronic proposal online, a unit price and a total price in the respective spaces provided for this purpose on the Bidder's Proposal form. In the case of unit basis items, the amount set forth under the "Total Price" column shall be the product of the unit price multiplied by the estimated quantity for the item.

In case of discrepancy between the unit price and the total set forth for the item, the unit price shall prevail, except however, that if the amount set forth as a unit price is ambiguous,

Bid No. 2018-008

unintelligible or uncertain for any reason, or if it is omitted, or is the same amount as the entry in the "Total Price" column, or in the case of lump sum items is not the same amount as the entry in the "Total Price" column, then the amount set forth in the "Total Price" column for the item shall prevail in accordance with the following:

- a. As to the lump sum items, the amount set forth in the "Total Price" column shall be the same amount in the unit price column, otherwise the amount set forth in the "Total Price" column shall prevail. Lump sum items are considered to be a unit of one.
- b. As to unit basis items, the amount set forth in the "Total Price" column shall be divided by the estimated quantity for the item and the price thus obtained shall be the unit price.

10. Withdrawal of Bidder's Proposals Bids may be withdrawn electronically on the PlanetBids Vendor Portal prior to the time set for opening of bids.

- a. No bid may be withdrawn or changed after the Bid deadline, except as otherwise provided by law. The lowest Bidder may only request relief of its Bid in accordance with Public Contract Code Section 5100 et seq. Each Bidder agrees by submitting a Bid that its Bid shall remain open, is irrevocable, and may not be modified, withdrawn, or cancelled for a period of at least **sixty (60) Calendar Days** after Bid Deadline.

11. Bid Security: As set forth in the Notice Inviting Bids, Each Bid shall be accompanied by a certified check or cashier's check payable to the City of Moreno Valley, or Bidder's Bond executed by the Bidder as principal and a California-admitted surety insurer (as defined by California Code of Civil Procedure §§ 995.120 and 995.311) in an amount of not less than **ten percent (10%)** of the amount of the total Bid price ("Bid Security"). Pursuant to California Public Contract Code Section 20170 & 20171, no Bid shall be considered unless such Bid Security is enclosed therewith. **If the Bidder elects to furnish a Bidder's Bond as his or her Bid security, the Bidder shall scan and upload the Bid Bond, and submit via the electronic vendor portal prior to the bid deadline.**

The City will request the original bid bonds of the three lowest bidders to be provided to the City within 72 hours of the bid deadline and shall retain the Bid Security of the first, second, and third lowest responsible Bidders until such time as the Agreement is executed. A notary certificate for the Bidder's signature shall be attached. The attorney-in-fact for a corporate surety must sign the bond, such signature shall be notarized, and a certified and notarized Power of Attorney duly authorizing the attorney-in-fact to act for the surety shall be submitted with the bond. The bond shall include the address at which the principal (Bidder) and surety may be served with notices, papers and other documents. If any of these items are not submitted with the Bid, the Bid shall be considered non-responsive and will be rejected.

The bidder may utilize a cashier's or certified check in lieu of a bid bond in the amount of ten percent (10%) of the base bid. If a cashier's or certified check is used, it shall be delivered to the City Clerk in a sealed envelope at 14177 Frederick Street, Moreno Valley, CA 92553 prior to the bid deadline specified herein. In the event that the successful Bidder withdraws its Bid prior to the expiration of **sixty (60) Calendar Days** after the Bid Deadline, or attempts to withdraw its Bid when the requirements of Public Contract Code § 5101 *et seq.* are not met, or refuses or fails to execute the Contract and provide the required bonds and insurance within **ten (10) Working Days** after award of the Contract, the Bid Security shall be retained by the City. In such event, the City may award the Contract for the Work to a responsible Bidder submitting the next lowest responsive Bid or may call for new Bids at the City's sole discretion. Pursuant to Public Contract Code Section 20174, if the Contract is awarded to the next lowest responsible

Deleted: ¶
¶

Bid No. 2018-008

Bidder, the defaulted Bidder's Bid Security shall be used to cover the difference between the lowest Bid Price and the second lowest Bid Price, and any surplus will be returned to the defaulted Bidder or surety.

12. **Contractor's Statement:** Each Bidder shall scan and submit with its electronic Bid, a Contractor's Statement (which is included within the Bidder's Proposal forms) completed by Bidder. The Contractor's Statements shall not be public records. All information required by the Contractor's Statement shall be completely and fully provided. Any Bid not accompanied by a Contractor's Statement completed with all information required and bearing the signature of the Bidder's duly authorized representative under penalty of perjury may render the Bid non-responsive and rejected. If the City determines that any information provided by a Bidder in the Contractor's Statement is false or misleading, or is so incomplete as to be false or misleading, the City may reject the Bid submitted by such Bidder as being non-responsive. Although the City will be reviewing qualifications, the City shall not apply a relative superiority analysis in making award of the Contract to the lowest responsive responsible Bidder.

13. **Subcontractors:**

Subcontractor List. Each Bidder shall submit with its electronic Bid, in the electronic form provided a list of proposed Subcontractors in accordance with the Subletting and Subcontracting Fair Practices Act, Public Contract Code Section 4100 *et seq.* If additive Alternate Bid Items are included in the Bidding Documents, Bidder shall identify Subcontractors performing additive Alternate Bid Items when such Work or combination of base Contract Work and alternate work exceeds one-half of one percent of the total Bid Price.

The City may require the three (3) lowest Bidders to submit other information pertinent to the proposed Subcontractor's quality, fitness, capacity, and experience to satisfactorily perform the Work. Failure to timely submit such additional Subcontractor information shall result in the Bid being deemed non-responsive and the Bid will be rejected by the City.

Work of Subcontractors. The organization or arrangements of the Specifications and Plans shall not limit the extent of the Work of the Contract Documents. Accordingly, all Bidders are encouraged to disseminate all of the Specifications, Drawings, and other Contract Documents to all persons or entities submitting sub-bids to the Bidder. The omission of any portion or item of Work from the Bid or from sub-bids that is reasonably inferable from the Contract Documents is not a basis for adjustment of the Contract Price or the Contract Time.

Bidder-Performed Work. After the Bid Deadline, the City may require the three (3) lowest Bidders to submit information about Bidder-performed Work including, but not limited to, the dollar value or percentage value of Work to be performed by Bidder in conformity with the Contract Documents. See Subsection 2-3.2, "Self Performance," of the Standard Specifications and City Special Provisions regarding requirements for Contractor-performed Work.

Ineligible Subcontractors. The successful Bidder is prohibited from performing Work on the Project with any Subcontractor who is ineligible to perform work on a public works project pursuant to Sections 1777.1 or 1777.7 of the California Labor Code. By submitting a Bid, each Bidder certifies that it has investigated the eligibility of each and every listed Subcontractor and has determined that none is ineligible to perform Work pursuant to the Labor Code.

Deleted: ¶

Deleted: ¶

Bid No. 2018-008

14. **Non-Collusion Affidavit:** In accordance with California Public Contract Code § 7106, the Bidder shall sign the Declaration of Non-collusion in the form contained in the Bidding Documents, under penalty of perjury, certifying that the Bid is not the result of and has not been influenced by collusion. Any Bid made without such declaration, or believed to be made in violation thereof, shall be deemed non-responsive. **Bidder shall scan and submit with its bid the Non-Collusion form contained herein.**
15. **Disqualification of Bidders:**
16. **Debarred Contractors.** No Bid will be accepted from a Bidder who is prohibited from performing work on a public works project pursuant to Sections 1777.1 or 1777.7 of the California Labor Code.
17. **Interest in More Than One Bid.** More than one Bid from an individual, firm, partnership, corporation, or an association under the same or different name will not be considered; however, a person, firm or corporation that has submitted a sub-bid to a Bidder or that has quoted prices of materials to a Bidder, is not thereby disqualified from submitting a sub-bid or quoting prices to other Bidders or making a Bid as the prime contractor. Reasonable grounds for believing that any Bidder has an interest in more than one Bid as a Bidder will cause the rejection of all Bids in which such Bidder is interested.
18. **Improperly Licensed.** No Bid will be accepted from a Bidder who, at the Bid Deadline, is not fully and properly licensed as a contractor in accordance with Chapter 9 of Division 3 of the California Business and Professions Code (Section 7000 et seq.). See the Notice Inviting Bids for identification of the license(s) required for this Project.
19. **Evaluation of Bids:**
- a. **Responsive Bid.** A responsive Bid is a Bid that conforms, in all material respects, to these Instructions to Bidders. Non-responsive Bids will be rejected.
 - b. **Responsible Bidder.** A responsible Bidder means a Bidder who has demonstrated the attributes of trustworthiness, quality, fitness, capacity, and experience to satisfactorily perform fully the requirements of the Contract Documents and the moral and business integrity and reliability that will assure good faith performance in the sole discretion of the City. The City's determination of a Bidder's responsibility or nonresponsibility shall be based on the fitness and capacity of the Bidder to satisfactorily perform the obligations of the Contract, whether or not the Bidder is qualified to perform those obligations, whether or not the Bidder is trustworthy, and such other bases as may be relevant. The City may consider, among other things: (1) any act or omission or pattern or practice of acts or omissions that negatively reflect on the Bidder's quality, fitness or capacity to perform; (2) any act or omission of Bidder that indicates a lack of integrity or honesty; (3) the making of a false claim against the City or any other public entity or engaging in collusion; (4) the Bidder's financial capability to perform; (5) the Bidder's experience with its sureties and insurance companies; (6) the Bidder's ability to perform on time and on budget, either in the present or as performed in the past; (7) whether or not Bidder has performed satisfactorily in the past on its contracts with the City or any other public entity, including, but not limited to, whether or not Bidder has been in default under a contract with the City or any other public entity; (8) the Bidder's safety record; (9) the Bidder's history of claims, litigation, and termination or disqualification on public projects; (10) Bidder's contract management skills, including, but not limited to, the use of scheduling tools, submission of schedules, compliance with prevailing wage rates, and

Bid No. 2018-008

certification of accurate payroll documents; and (11) whether or not Bidder is currently or was previously debarred by any public agency.

- c. **Reservation of Rights:** The City reserves the right, in its sole discretion, to: judge the Bidder's representations as stated in the Bidder's Proposal forms, including the Contractor's Statement, and any post-Bid information to determine whether or not Bidder is qualified to perform the Work; be the sole judge regarding the suitability of the products, services or supplies offered; to not purchase all items or the full quantity of each item listed in the Bidding Documents; reject any or all Bids; modify, cancel or withdraw the Notice Inviting Bids; issue a new Notice Inviting Bids; suspend or abandon the Project; appoint evaluation committees to review bids; and seek the assistance of outside technical experts in Bid evaluation; waive deficiencies, informalities and minor irregularities in any Bid or in the bidding process; require a Bidder to provide a guarantee (or guarantees) of the Contract by a third party; not issue a Notice to Proceed after execution of the Contract. In submitting a Bid in response to the Notice Inviting Bids, the Bidder is specifically acknowledging the City holds these rights.
- d. The Notice Inviting Bids does not commit the City to enter into a Contract, to reject, in its sole discretion, all Bids, nor does it obligate the City to pay for any costs incurred in preparation and submission of a Bid or in anticipation of a contract. By submitting a Bid, the Bidder disclaims any right to be paid for such costs.

20. **Rejection of Bidder's Proposals:** Any Bid containing information which is subsequently proven false or improperly signed shall be considered non-responsive and shall be rejected by the City. A Bid **shall** be rejected as non-responsive:
- a. If the Bid shows any alterations of form or material additions not called for.
 - b. If the Bid contains additional or alternate Bid Items not called for.
 - c. If the Bidder adds any provisions reserving its rights to accept or reject any award of Contract.
 - d. If the Bid Bond/Security does not accompany the Bid.
 - e. If the Bid fails to provide required information except as allowed by law.
 - f. If the Bid fails to indicate that Work valued at least fifty percent (50%) of Contract Price (except Specialty Items) will be performed by the Bidder's own forces, in accordance with Section 2-3.2 of the City Special Provisions.
 - g. If the Bid is transferred to another Bidder.
 - h. If the Bid is received after the designated deadline.
 - i. If the Bid is oral, telephoned, faxed, e-mailed, or telegraphed.
 - j. If the Bidder has been debarred pursuant to California Labor Code Sections 1777.1 or 1777.7 (see Paragraph 16.1 above).

Bid No. 2018-008

A Bid **may** be rejected as non-responsive if it contains irregularities of any kind; however, the City reserves the right to waive irregularities to the extent permitted by law, as well as to reject any and all Bids. Bids may be considered irregular and may be rejected for reasons that include, but are not limited to, the following:

- k. If there are material qualifications, conditions, or irregularities of any kind which may make the Bid incomplete, indefinite, or ambiguous.
- l. If the Bid Price or unit prices provided by Bidder are obviously unbalanced or are excessive or may materially affect the final cost of the Work.
- m. If Bidder has been delinquent or unfaithful in the performance of any former contract with the City.
- n. If the City determines that any information provided by a Bidder is false or misleading, or is so incomplete as to be false or misleading.

21. **Award of Contract:** The lowest responsible Bidder will be determined by comparing the total Bid Price of all Base Bid Items plus Alternate Bid Items, using the Engineer's estimate of quantities for the Work as set forth in the Bidder's Proposal. The City reserves the right to select any, all, or none of the Alternate Bid Items at the time of award of the Contract. In the event that any or all of the Alternate Bid Items are not awarded as part of the Contract, the City reserves the right to add any or all of the Alternate Bid Items by Change Order or Construction Change Directive at the prices set forth in the Bid. The award of the Contract, if made, will be within sixty (60) Calendar Days after Bid Opening. In the event award is not made within a sixty (60) day period, the selected Contractor, if any, may submit to the City claim(s) for additional costs incurred between the end of said sixty (60) day period and date of actual award. All reasonable claims will be considered, and any justifiable costs shall be added to the Contract pursuant to a Change Order.
22. **Execution of Contract:** The Agreement shall be signed by the successful Bidder in duplicate counterpart and returned, together with the required bonds and insurance certificate(s), within ten (10) Working Days after the date the Agreement is awarded to the successful Bidder by the City. The Contract shall not be binding upon the City until same has been completely executed by the Contractor and the City.
23. **Bonds and Insurance:** The successful Bidder shall furnish a Performance Bond and a Labor and Materials Payment Bond, each in the penal amount of 100% of the Contract Price. Bond forms for execution will be provided by the City when the Contract is tendered to the successful Bidder. Bonds may be secured through the Bidder's usual sources. The cost of furnishing the bonds shall be included in the Bid. Bonds issued by a California-admitted surety insurer listed on Treasury Circular 570 shall be deemed accepted unless specifically rejected by the City. Bonds issued by sureties not listed in Treasury Circular 570 must be accompanied by all documents enumerated in California Code of Civil Procedure Section 995.660. The bonds are subject to the requirements of **Paragraph 8** of the Agreement. The Bidder selected for award of the Contract will be required to furnish the City with a certificate of liability insurance coverage, an insurance endorsement, and workers' compensation certification in the coverage amounts specified in **Paragraph 7** of the Agreement. The successful Bidder shall deliver the signed Agreement, bonds, and insurance to the City within **ten (10) Working Days** after the Contract is awarded to the successful Bidder.
24. **Permits and Fees:** Refer to Section 7-5 of the City Special Provisions.

Deleted: ¶

Bid No. 2018-008

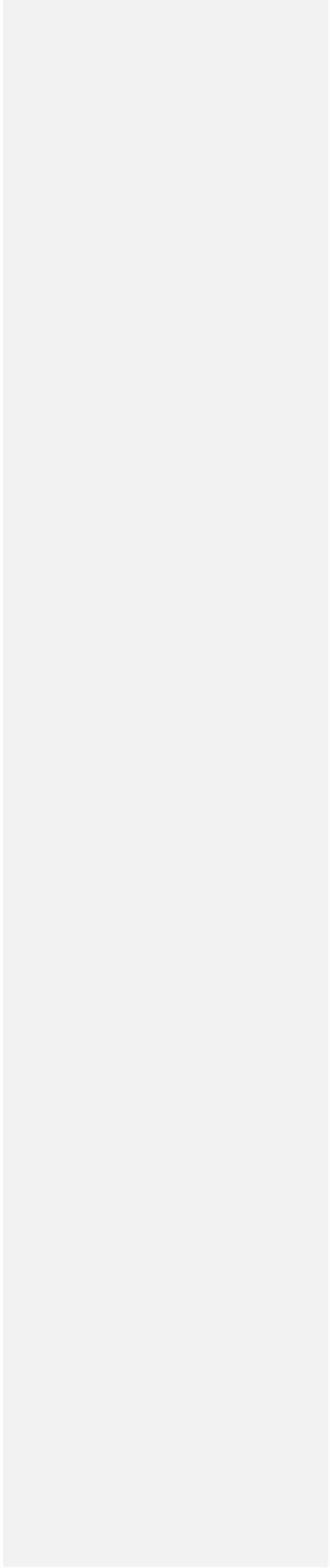

Bid No. 2018-008

**BIDDER'S PROPOSAL
PROJECT NO. PCS HSG GR - JFK RENO**

**PROJECT NAME: JOHN F. KENNEDY
VETERANS MEMORIAL PARK –
RESTROOM IMPROVEMENTS**

CERTIFICATION OF INSPECTION OF THE SITE AND CONTRACT DOCUMENTS. By submitting an electronic bid, Bidder certifies that it: has carefully examined the location of the proposed Work, is fully familiar with all Contract Documents, including the City Special Provisions, Plans, and Addenda, Plans, and that said Contract Documents contain sufficient detail regarding the Work to be performed; has notified Owner of any errors or omissions in the Contract Documents and unusual site conditions; has carefully checked all words, prices, and statements in this Bidder's Proposal; and has visited the Project site and conducted such other field investigations which are prudent and reasonable in preparing the Bid. Bidder agrees that neither the City of Moreno Valley, nor the Moreno Valley Housing Authority, nor the Moreno Valley Community Services District, nor the City as Successor Agency for the Community Redevelopment Agency of the City of Moreno Valley *for RDA only*, nor the Western Riverside Council of Governments *for TUMF only*, nor any officer or employee therefore will be responsible for any misunderstandings, errors or omissions on the part of the undersigned in submitting this Bid.

BIDDER'S REPRESENTATIONS REGARDING INSURANCE AND BONDS. This Bid is made with the full knowledge of the kind, quantity, and quality of the materials and Work required and, if it is accepted by the City, the Bidder shall enter into a Contract and furnish the bonds, insurance, and other documents as required by the Contract Documents within ten (10) Working Days after award of the Contract. The Bidder agrees that failure to execute and return the Agreement or the required faithful performance bond, labor and materials payment bond, and insurance certificates to the City within said ten (10) Working Days shall be sufficient cause for the rescission of the award and forfeiture of the Bid Security.

TIME FOR COMPLETION. The Bidder agrees that if awarded the Contract, it shall complete all preconstruction requirements, ordering of materials, and construction of the Project within the Contract Time established in **Paragraph 5** of the Agreement and within the duration(s) established to Fulfill Preconstruction Requirements and to Order Materials.

NON-COLLUSION AFFIDAVIT. Bidder being first duly sworn, deposes and says that the party who submits herewith a Bid to the City; that the Bid is not made in the interest of, or on behalf of, any undisclosed person, partnership, company, association, organization, or corporation; that the Bid is genuine and not collusive or sham; that the Bidder has not directly or indirectly induced or solicited any other Bidder to put in a false or sham Bid, and has not directly or indirectly colluded, conspired, connived, or agreed with any Bidder or anyone else to put in a sham Bid, or that anyone shall refrain from bidding; that the Bidder has not in any manner, directly or indirectly sought by agreement, communication, or conference with anyone to fix the Bid price of the Bidder or any other Bidder, or to fix any overhead, profit, or cost element of the Bid price, or of that of any other Bidder, or to secure any advantage against the City of anyone interested in the proposed Contract; that all statements contained in the Bid are true; and, further, that the Bidder has not, directly or indirectly, submitted his or her Bid Price or any breakdown thereof, or the contents thereof, or divulged information or data relative thereto, or paid, and will not pay, any fee to any corporation, partnership, company associations, organization, bid depository, or to any member or agent thereof to effectuate a collusive or sham Bid. **Bidder acknowledges acceptance and agreement with the above by agreeing to the terms and conditions at the time of electronic bid submittal.**

Bid No. 2018-008

Bid Schedule shown is for reference purposes only. Bid Schedule must be completed electronically.
The link to register to become a prospective bidder and electronically bid on this project can be found at the following address: <http://www.planetbids.com/portal/portal.cfm?CompanyID=24660>

BIDDER'S PROPOSAL – BID SCHEDULE
PROJECT NO. PCS HSG GR - JFK RENO
JOHN F. KENNEDY VETERANS MEMORIAL PARK - RESTROOM IMPROVEMENTS

BASE BID ITEMS AS FOLLOWS:

| DESCRIPTION OF ITEMS PER PLANS AND SPECIFICATIONS | QTY. | UNIT | UNIT COST | TOTAL COST |
|--|------|------|-----------|------------|
| MOBILIZATION | | | | |
| 1 MOBILIZATION AND DEMOBILIZATION | 1 | LS | | |
| 2 PORTABLE RESTROOM | 1 | LS | | |
| 3 STORAGE CONTAINER | 1 | LS | | |
| 4 TEMPORARY FENCING (APPROXIMATELY 400 LF) | 1 | LS | | |
| 5 TEMPORARY WATER AND POWER FOR CONSTRUCTION | 1 | LS | | |
| 6 EROSION AND DUST CONTROL | 1 | LS | | |
| 7 TREE PROTECTION | 9 | EA | | |
| 8 INSURANCE AND BONDING | 1 | LS | | |
| 9 AS-BUILTS | 1 | LS | | |
| 10 SUBMITTALS | 1 | LS | | |
| 11 CONSTRUCTION STAKING (CIVIL ENGINEER TO CERTIFY BUILDING PAD) | 1 | LS | | |
| MOBILIZATION TOTAL | | | | |
| DEMOLITION AND GRADING | | | | |
| 12 REMOVAL AND DISPOSAL OF EXISTING GRASS | 3820 | SF | | |
| 13 REMOVAL AND DISPOSAL OF EXISTING CONCRETE CURB | 12 | LF | | |
| 14 REMOVAL AND DISPOSAL OF EXISTING 4" CONCRETE | 240 | SF | | |
| 15 REMOVE AND SALVAGE EXISTING PICNIC TABLES | 2 | EA | | |
| 16 REMOVAL AND DISPOSAL OF SOIL FOR FLATWORK SUBGRADE | 30 | CY | | |
| 17 REMOVAL AND DISPOSAL OF SOIL FOR RESTROOM SUBGRADE | 49 | CY | | |
| <i>*Including Footing Material And Utility Trench Material</i> | | | | |
| 18 REMOVAL AND DISPOSAL SOIL FOR POLYGON STRUCTURE FOOTINGS | 9 | CY | | |
| 19 FINE GRADING AND COMPACTION FOR HARDSCAPE | 1 | LS | | |
| 20 COMPACTION TESTING FOR CONCRETE AND BUILDING SUBGRADE | 1 | LS | | |
| DEMOLITION AND GRADING TOTAL | | | | |
| UTILITIES | | | | |
| 21 PVC SEWER LINE - 4" (STREET TIE IN AND LATERAL LINE) | 82 | LF | | |
| <i>*Include all necessary street and public sidewalk repairs</i> | | | | |
| 22 PROVIDE AND INSTALL 4"-SEWER CLEAN OUT | 1 | EA | | |
| 23 NEW 1-1/2"-DOMESTIC WATER LINE SERVICE (STREET LATERAL LINE ONLY) | 26 | LF | | |
| <i>*Include all necessary street and public sidewalk repairs</i> | | | | |
| <i>*EMWD to do hot tap on street for domestic water service only</i> | | | | |
| 24 PROVIDE AND INSTALL 1" DOMESTIC WATER METER CONCRETE BOX | 1 | EA | | |
| <i>*EMWD to provide and install 1"-domestic water meter</i> | | | | |
| 25 PROVIDE AND INSTALL 1" BACKFLOW PREVENTER | 1 | EA | | |
| 26 PROVIDE AND INSTALL SBBC-30SS BACKFLOW ENCLOSURE | 1 | EA | | |
| 27 TRAFFIC CONTROL FOR ITEMS IN STREET (INCLUDING PLAN) | 1 | LS | | |
| UTILITIES TOTAL | | | | |

Bid No. 2018-008

BASE BID ITEMS AS FOLLOWS:

| DESCRIPTION OF ITEMS PER PLANS AND SPECIFICATIONS | | | QTY. | UNIT | UNIT COST | TOTAL COST |
|---|---|------|------|------|-----------|------------|
| HARDSCAPE | | | | | | |
| 28 | 6"-THICK COLORED CONCRETE PAVING WITH REBAR | 2434 | SF | | | |
| 29 | 6"X6" CONCRETE MOWSTRIP | 23 | LF | | | |
| 30 | 3"-LAYER OF STABILIZED DECOMPOSED GRANITE | 80 | SF | | | |
| HARDSCAPE TOTAL | | | | | | |
| SITE FEATURES | | | | | | |
| 31 | BARBEQUE GRILL - CONCRETE | 2 | EA | | | |
| 32 | BARBEQUE GRILL INSTALLATION | 2 | EA | | | |
| 33 | PICNIC TABLE - 6' | 2 | EA | | | |
| 34 | PICNIC TABLE INSTALLATION | 2 | EA | | | |
| 35 | TRASH RECEPTACLE - CONCRETE | 1 | EA | | | |
| 36 | TRASH RECEPTACLE INSTALLATION | 1 | EA | | | |
| SITE FEATURES TOTAL | | | | | | |
| SITE STRUCTURES | | | | | | |
| <i>POLYGON STRUCTURE</i> | | | | | | |
| 37 | PROVIDE 24'-WIDE POLYGON PICNIC SHELTER | 1 | EA | | | |
| | <i>*BY SUPPLIER</i> | | | | | |
| 38 | ASSEMBLE AND INSTALL POLYGON STRUCTURE | 1 | LS | | | |
| | <i>*BY CONTRACTOR</i> | | | | | |
| 39 | FOOTINGS FOR POLYGON STRUCTURE WITH REBAR CAGE | 6 | EA | | | |
| | <i>*BY CONTRACTOR</i> | | | | | |
| SITE STRUCTURES TOTAL | | | | | | |
| RESTROOM/STORAGE STRUCTURE | | | | | | |
| 40 | PROVIDE AND INSTALL RESTROOM/STORAGE BUILDING (708 SF.) | 1 | S | | | |
| | <i>*BY SUPPLIER</i> | | | | | |
| 41 | 24"X18" POUR IN PLACE CONTINUOUS FOOTING WITH REBAR | 104 | LF | | | |
| | <i>*BY CONTRACTOR</i> | | | | | |
| 42 | 2"-THICK LAYER OF COARSE SAND UNDER STRUCTURE | 684 | SF | | | |
| | <i>*BY CONTRACTOR</i> | | | | | |
| 43 | SAND BACKFILL FOR UTILITIES UNDER RESTROOM STRUCTURE | 14 | CY | | | |
| | <i>*BY CONTRACTOR</i> | | | | | |
| 44 | EXPANSION JOINT (BUILDING ADJACENT TO HARDSCAPE) | 81 | LF | | | |
| | <i>*BY CONTRACTOR</i> | | | | | |
| 45 | DOWEL BUILDING TO ADJACENT HARDSCAPE | 81 | LF | | | |
| | <i>*BY CONTRACTOR</i> | | | | | |
| RESTROOM STRUCTURE TOTAL | | | | | | |
| PLANTING | | | | | | |
| 46 | FINE GRADING FOR LANDSCAPE | 742 | SF | | | |
| 47 | SOIL PREP | 742 | SF | | | |

Bid No. 2018-008

BASE BID ITEMS AS FOLLOWS:

| DESCRIPTION OF ITEMS PER PLANS AND SPECIFICATIONS | | QTY. | UNIT | UNIT COST | TOTAL COST |
|---|---|------|------|-----------|------------|
| 48 | WEED ABATEMENT | 742 | SF | | |
| 49 | SHRUBS (1 GAL) | 32 | EA | | |
| 50 | SHRUBS (5 GAL) | 37 | EA | | |
| 51 | SHRUBS (15 GAL) | 7 | EA | | |
| 52 | WOOD MULCH | 7 | CY | | |
| 53 | SOD REPAIR ALLOWANCE DUE TO CONSTRUCTION | 800 | SF | | |
| 54 | 90 DAY MAINTENANCE | | | | |
| PLANTING TOTAL | | | | | |
| IRRIGATION | | | | | |
| 55 | AUTOMATIC IRRIGATION SYSTEM MODIFICATION | 1 | LS | | |
| 56 | HARDLINE DRIP AREAS | 742 | SF | | |
| IRRIGATION TOTAL | | | | | |
| LIGHTING AND ELECTRICAL | | | | | |
| 57 | RESTROOM / PICNIC SHELTER | 1 | EA | | |
| | <i>*(430 LF) 1 -1/2" CONDUIT WITH WIRE</i> | | | | |
| | <i>*(4 EACH) CONCRETE PULL BOXES WITH LOCK</i> | | | | |
| | <i>*(25 LF) RIGID STEEL CONDUIT AT POLYGON SHELTER</i> | | | | |
| | <i>*(1 EACH) POLYGON SHELTER LIGHT ON CENTER OF STRUCTURE</i> | | | | |
| LIGHTING AND ELECTRICAL TOTAL | | | | | |
| PARKING STALL IMPROVEMENTS | | | | | |
| 58 | NEW STRIPING - DOUBLE LINE STALLS (EXCEPT ADA) | 3 | EA | | |
| 59 | NEW STRIPING (DISABLED) - EMBLEM & SIGN | 1 | EA | | |
| 60 | PROVIDE AND INSTALL PRECAST CONCRETE PARKING WHEEL STOP | 1 | EA | | |
| 61 | PROVIDE AND INSTALL VAN ACCESSIBLE PARKING SIGNAGE AND POST | 1 | EA | | |
| 62 | NEW POUR IN PLACE CONCRETE RAMP WITH TRUNCATED DOME | 1 | EA | | |
| PARKING STALL IMPROVEMENT TOTAL | | | | | |
| TOTAL BASE BID PRICE (BASED ON ESTIMATED QUANTITIES OF ITEMS 1 THROUGH 62) | | | | | |

Note: Estimated quantities are for the purpose of Bid comparison only; payments will be made on the basis of actual measurement of Work completed, except for lump sum (LS) and final pay (F) quantities. (S) denotes a specialty item. The Bid Price shall include, but not be limited to, sales tax and all other applicable taxes and fees.

Bid No. 2018-008

BOND NO. _____

BID BOND

**JOHN F. KENNEDY
VETERANS MEMORIAL PARK –
RESTROOM IMPROVEMENTS
PROJECT NO. PCS HSG GR - JFK RENO**

KNOW ALL MEN OR WOMEN BY THESE PRESENTS:

That _____, as Principal, hereinafter referred to as

"Contractor," and _____, a duly authorized corporate as Surety, are held and firmly bound unto the City of Moreno Valley in the penal sum of TEN PERCENT (10%) OF THE TOTAL AMOUNT OF THE BID (Total Base Bid Price plus Alternate Bid Price, if any) of the Contractor above named, submitted by said Contractor to the City of Moreno Valley for the Work for said Project entitled above, for the payment of which sum in lawful money of the United States, well and truly to be made, to the City of Moreno Valley to which said Bid was submitted, we bind ourselves, our heirs, executors, administrators and successors, jointly and severally liable (CCP 995.320 (a)(1), PCC 20171), firmly by these presents. In no case shall the liability of the Surety hereunder exceed the amount of:

_____.

THE CONDITION OF THIS OBLIGATION IS SUCH:

That whereas the Contractor has submitted the above-mentioned Bid to the City of Moreno Valley as aforesaid for the Work for said Project entitled above.

NOW, THEREFORE, if the aforesaid Contractor is awarded the Contract and, within the time and manner required under the Bid Documents, after the prescribed forms are presented to him or her for signature, enters into a written Agreement in the prescribed form and in accordance with the Bid Documents, and files two bonds with the City of Moreno Valley, one to guarantee Faithful Performance and the other to guarantee payment for labor and materials, in accordance with said Bidding Documents, and as required by law, and files the required insurance certificate(s) in accordance with said Bidding Documents, then this obligation shall be null and void; otherwise, it shall be and remain in full force and effect until execution of the Agreement or forfeiture pursuant to the Provisions of Sections 20172 and 20174 of the Public Contract Code. The Surety hereby waives notice of an agreement between the City and Contractor to extend the time in which the City may accept the Bid.

In the event suit is brought upon this bond by the City and judgment is recovered, the Surety shall pay all costs incurred by the City in such suit, including a reasonable attorney fee to be fixed by the court.

(SIGNATURE PAGE FOLLOWS)

Attachment: Request for Bid PCS HSG GR-JFK RENO_AD FINAL PB (2845 : APPROVE AND EXECUTE AGREEMENT FOR THE INSTALLATION

Bid No. 2018-008

IN WITNESS WHEREOF, we have hereunto set our hands and seals on this ____ day of _____, 20____.

BIDDER (Principal)

CORPORATE SURETY

Name: _____

Company Name: _____

Address: _____

Address: _____

Telephone No.: _____

Telephone No.: _____

Print Name: _____

Print Name: _____

Title: _____

Signature: _____

Signature: _____
(Attorney-In-Fact)

Date: _____

Date: _____

SIGNING INSTRUCTIONS

- The bond shall be executed by a California admitted surety insurer (CCP 995.311).
- The bond shall include an attached Notary Certificate for the Attorney-in-Fact.
- The bond shall include an attached Notary Certificate for the Bidder.
- The bond shall include an attached original Power of Attorney only authorizing the Attorney-in-Fact to act for the Surety.
- The bond shall include the address at which the Principal (Bidder) and Surety may be served with notices, papers and other documents.

If any of the above items are omitted, the Bid will be considered non-responsive and will be rejected.

CALIFORNIA ALL-PURPOSE CERTIFICATE OF ACKNOWLEDGMENT

State of California

County of _____ **SAMPLE**
On _____ before me, _____,
(Here insert name and title of the officer)

personally appeared _____,

who proved to me on the basis of satisfactory evidence to be the person(s) whose name(s) is/are subscribed to the within instrument and acknowledgement to me that he/she they executed the same in his/her/their authorized capacity(ies), and that by his/her/their signature(s) on the instrument the person(s), or the entity upon behalf of which the person(s) acted, executed the instrument.

I certify under PENALTY OF PERJURY under the laws of the State of California that the foregoing paragraph is true and correct.

WITNESS my hand and official seal.

Signature of Notary Public (Notary Seal)

Deleted: ¶

ADDITIONAL OPTIONAL INFORMATION

INSTRUCTIONS FOR COMPLETING THIS FORM

Any acknowledgment completed in California must contain verbiage exactly as appears above in the notary section or a separate acknowledgment form must be properly completed and attached to that document. The only exception is if a document is recorded outside of California. In such instances, any alternative acknowledgment verbiage as may be printed on such a document so long as the verbiage does not require the notary to do something that is illegal for a notary in California (i.e. certifying the authorized capacity of the signer). Please check the document carefully for proper notarial wording and attach this form if required.

- State and County information must be the State and County where the document signer(s) personally appeared before the notary public for acknowledgment.
- Date of notarization must be the date that the signer(s) personally appeared which must also be the same date the acknowledgment is completed.
- The notary public must print his or her name as it appears within his or her commission followed by a comma and then your title (notary public).
- Print the name(s) of document signer(s) who personally appear at the time of notarization.
- Indicate the correct singular or plural forms by crossing off incorrect forms (i.e. ~~he~~/she/~~they~~, is/~~are~~) or circling the correct forms. Failure to correctly indicate this information may lead to rejection of document recording.
- The notary seal impression must be clear and photographically reproducible. Impression must not cover text or lines. If seal impression smudges, re-seal if a sufficient area permits, otherwise complete a different acknowledgment form.
- Signature of the notary public must match the signature on file with the office of the county clerk.
 - ❖ Additional information is not required but could help to ensure this acknowledgment is not misused or attached to a different document.
 - ❖ Indicate title or type of attached document, number of pages and date.
 - ❖ Indicate the capacity claimed by the signer. If the claimed capacity is a corporate officer, indicate the title (i.e. CEO, CFO, Secretary).
- Securely attach this document to the signed document.

DESCRIPTION OF THE ATTACHED DOCUMENT

BIDDER'S BOND SIGNATURE PAGE
(Title or description of attached document)

(Title or description of attached document continued)

CAPACITY CLAIMED BY THE SIGNER

Individual(s)

Corporate Officer

(Title)

Partner (s)

Attorney-in-Fact

Other

Attachment: Request for Bid PCS HSG GR-JFK RENO_AD FINAL PB (2845 : APPROVE AND EXECUTE AGREEMENT FOR THE INSTALLATION

Bid No. 2018-008

BIDDER'S PROPOSAL – CONTRACTOR'S STATEMENT

SUBMIT WITH ELECTRONIC BID SUBMISSION
JOHN F. KENNEDY
VETERANS MEMORIAL PARK –
RESTROOM IMPROVEMENTS

NAME OF BIDDER: _____

Deleted: ¶

GENERAL

To be considered, all information requested must be submitted on this Contractor's Statement form or on sheets which clearly identify the paragraph number and subparts being responded to. Additionally, to the extent this form does not provide sufficient space to fully respond, contractors should attach additional sheets as necessary referencing the appropriate paragraph number and subparagraph. The Contractor's Statement shall not be public records. The Contractor's Statement will need to be scanned and uploaded with bid submission onto the Planet Bids website.

All questions must be answered and the data must be clear and complete. Line items that do not require a response shall be noted with a "N/A" referencing items that are not applicable.

1. Contractor is able to obtain insurance for the Bid Package with the minimum scope and limits specified in **Paragraph 7** of the Agreement.
 Yes No

2. Contractor has current workers' compensation insurance policy as required by the Labor Code or is legally self-insured pursuant to Labor Code section 3700 *et seq.*
 Yes No
 Contractor is exempt from this requirement, because it has no employees

3. Have you been in business for a minimum of **three (3) years** under the contractor's license used for the Bid you are submitting?
 Yes No

4. Have you satisfactorily completed: **1)** at least **one (1)** prevailing wage public contract in California; **and 2)** at least **one (1)** contract comparable in scope and scale to the Project for which the Bid is submitted, completed within **five (5)** years prior to the Bid Deadline and with the dollar value of Bidder's portion of each such project in excess of the Base Bid Price submitted for this Project?
 Yes No

Bid No. 2018-008

5. Has your contractor's license been revoked at any time in the last five years?
 Yes No

Deleted: ¶

6. Has a surety firm completed a contract on your behalf, or paid for completion because your firm was default terminated by the project owner within the last five (5) years?
 Yes No

Deleted: ¶
¶

7. Complete the following information for each project for which a bonding company has had to complete any part of your work during the last five (5) years. (Attach additional sheets as necessary.)

- (a) Project: _____
- (b) Amount Bonded: _____
- (c) Bonding Company: _____
- (d) Percent of Project Completed: _____
- (e) Name of Contractor Completing Project: _____

8. At the time of submitting this form, is your firm ineligible to bid on or be awarded a public works contract, or perform as a subcontractor on a public works contract, pursuant to Labor Code section 1777.1, Labor Code section 1777.7?
 Yes No

If the answer is "Yes," state the beginning and ending dates of the period of debarment:

9. At the time of submitting this form, is your firm debarred or otherwise ineligible to bid on or be awarded contracts from the City of Moreno Valley, the federal government, or any other public agencies in California?
 Yes No

If the answer is "Yes," state the beginning and ending dates of the period of debarment:

10. At any time during the last five years, has your firm, or any of its owners or officers, been convicted of a crime involving the awarding of a contract of a government construction project, or the bidding or performance of a government contract?
 Yes No

Bid No. 2018-008

11. Has your firm, or any of its owners or officers, been issued, within a two (2) year period, three (3) final administrative or criminal citations for violations of the City of Moreno Valley Municipal Code?

Yes No

12. How many years has your organization been in business? _____

What year was your organization established? _____

13. How many years has your organization been in business under its present business name?

Under what other or former names has your organization operated?

14. Identify parent company if applicable: _____

15. Have you ever been licensed under a different name or different license number?

Yes No

If the answer is yes, give name and license number: _____

Complete the following information for **completed** construction contracts with public agencies, including, but not limited to contracts with the City of Moreno Valley. (List three projects maximum. Attach additional sheets as necessary, but answer all questions identified below for each project.)

Project #1

(a) Name of Agency's Project Manager: _____

(b) Name of Project: _____

(c) Name of Agency: _____

(d) Project Address: _____

City: _____ State: _____ Zip: _____

(e) Agency's Contact Phone: (____) _____

(f) Type of Facility: _____

(g) Contract Type: _____

Bid No. 2018-008

- (h) Contract Amount: _____
- (i) Percent Change Orders to Base Contract: _____
- (j) Percent Complete: _____
- (k) Percent Work Performed With Own Forces: _____
- (l) Scheduled Completion Date: _____
- (m) Actual Completion Date: _____
- (n) Explain any differences between scheduled and actual completion dates:

- (o) Explain any differences between the original contract price and the actual cost to complete:

Deleted: ¶
¶

Deleted: ¶

Project #2

- (a) Name of Agency's Project Manager: _____
- (b) Name of Project: _____
- (c) Name of Agency: _____
- (d) Project Address: _____

City: _____ State: _____ Zip: _____
- (e) Agency's Contact Phone: (____) _____
- (f) Type of Facility: _____
- (g) Contract Type: _____
- (h) Contract Amount: _____
- (i) Percent Change Orders to Base Contract: _____
- (j) Percent Complete: _____
- (k) Percent Work Performed With Own Forces: _____
- (l) Scheduled Completion Date: _____
- (m) Actual Completion Date: _____
- (n) Explain any differences between scheduled and actual completion dates: _____

- (o) Explain any differences between the original contract price and the actual cost to complete:

Bid No. 2018-008

Deleted: ¶

Project #3

- (a) Name of Agency's Project Manager: _____
- (b) Name of Project: _____
- (c) Name of Agency: _____
- (d) Project Address: _____

City: _____ State: _____ Zip: _____

- (e) Agency's Contact Phone: (____) _____
- (f) Type of Facility: _____
- (g) Contract Type: _____
- (h) Contract Amount: _____
- (i) Percent Change Orders to Base Contract: _____
- (j) Percent Complete: _____
- (k) Percent Work Performed With Own Forces: _____
- (l) Scheduled Completion Date: _____
- (m) Actual Completion Date: _____
- (n) Explain any differences between scheduled and actual completion dates: _____

- (o) Explain any differences between the original contract price and the actual cost to complete: _____

16. List any projects in which your organization has been involved in any claim for delay, extra work or equitable contract adjustment in the last five years in which the amount in controversy exceeded \$25,000. Identify claims by name of project, parties involved, description of claim and ultimate resolution (attach additional sheets as necessary):

- (a) Name of Project: _____
- (b) Project Location: _____
- (c) Date of Claim: _____

Bid No. 2018-008

- (d) Parties Involved: _____

- (e) Description of Claim: _____

- (f) Result: _____

17. Has your organization ever been terminated from a project before completion? If so, please provide the following information: (List three projects maximum. Attach additional sheets as necessary.)

Project #1

- (a) Name of Project: _____
- (b) Project Location: _____
- (c) Client Name: _____
- (d) Client Contact: _____
Client Telephone No: _____
- (e) Architect Name: _____
- (f) Architect Telephone No: _____
- (g) Date of Termination: _____
- (h) Reason for Termination: _____

Project #2

- (a) Name of Project: _____
- (b) Project Location: _____
- (c) Client Name: _____
- (d) Client Contact: _____
- (e) Client Telephone No: _____
- (f) Architect Name: _____
- (g) Architect Telephone No: _____
- (h) Date of Termination: _____

Bid No. 2018-008

(i) Reason for Termination: _____

Project #3

- (a) Name of Project: _____
- (b) Project Location: _____
- (c) Client Name: _____
- (d) Client Contact: _____
- (e) Client Telephone No: _____
- (f) Architect Name: _____
- (g) Architect Telephone No: _____
- (h) Date of Termination: _____
- (i) Reason for Termination: _____

I, the undersigned, certify and declare that I have read all the foregoing answers to the questionnaire and know their contents. The matters stated in the questionnaire answers are true of my own knowledge and belief, except as to those matters stated on information and belief, and as to those matters I believe them to be true. I declare under penalty of perjury under the laws of the State of California that the foregoing is correct.

Company Name: _____

Dated: _____ Signed: _____
Name: _____
Title: _____

Bid No. 2018-008

California Public Contract Code § 9204 (full text)

9204. (a) The Legislature finds and declares that it is in the best interests of the state and its citizens to ensure that all construction business performed on a public works project in the state that is complete and not in dispute is paid in full and in a timely manner.

(b) Notwithstanding any other law, including, but not limited to, Article 7.1 (commencing with Section 10240) of Chapter 1 of Part 2, Chapter 10 (commencing with Section 19100) of Part 2, and Article 1.5 (commencing with Section 20104) of Chapter 1 of Part 3, this section shall apply to any claim by a contractor in connection with a public works project.

(c) For purposes of this section:

(1) "Claim" means a separate demand by a contractor sent by registered mail or certified mail with return receipt requested, for one or more of the following:

(A) A time extension, including, without limitation, for relief from damages or penalties for delay assessed by a public entity under a contract for a public works project.

(B) Payment by the public entity of money or damages arising from work done by, or on behalf of, the contractor pursuant to the contract for a public works project and payment for which is not otherwise expressly provided or to which the claimant is not otherwise entitled.

(C) Payment of an amount that is disputed by the public entity.

(2) "Contractor" means any type of contractor within the meaning of Chapter 9 (commencing with Section 7000) of Division 3 of the Business and Professions Code who has entered into a direct contract with a public entity for a public works project.

(3) (A) "Public entity" means, without limitation, except as provided in subparagraph (B), a state agency, department, office, division, bureau, board, or commission, the California State University, the University of California, a city, including a charter city, county, including a charter county, city and county, including a charter city and county, district, special district, public authority, political subdivision, public corporation, or nonprofit transit corporation wholly owned by a public agency and formed to carry out the purposes of the public agency.

(B) "Public entity" shall not include the following:

(i) The Department of Water Resources as to any project under the jurisdiction of that department.

(ii) The Department of Transportation as to any project under the jurisdiction of that department.

(iii) The Department of Parks and Recreation as to any project under the jurisdiction of that department.

Bid No. 2018-008

(iv) The Department of Corrections and Rehabilitation with respect to any project under its jurisdiction pursuant to Chapter 11 (commencing with Section 7000) of Title 7 of Part 3 of the Penal Code.

(v) The Military Department as to any project under the jurisdiction of that department.

(vi) The Department of General Services as to all other projects.

(vii) The High-Speed Rail Authority.

(4) "Public works project" means the erection, construction, alteration, repair, or improvement of any public structure, building, road, or other public improvement of any kind.

(5) "Subcontractor" means any type of contractor within the meaning of Chapter 9 (commencing with Section 7000) of Division 3 of the Business and Professions Code who either is in direct contract with a contractor or is a lower tier subcontractor.

(d) (1) (A) Upon receipt of a claim pursuant to this section, the public entity to which the claim applies shall conduct a reasonable review of the claim and, within a period not to exceed 45 days, shall provide the claimant a written statement identifying what portion of the claim is disputed and what portion is undisputed. Upon receipt of a claim, a public entity and a contractor may, by mutual agreement, extend the time period provided in this subdivision.

(B) The claimant shall furnish reasonable documentation to support the claim.

(C) If the public entity needs approval from its governing body to provide the claimant a written statement identifying the disputed portion and the undisputed portion of the claim, and the governing body does not meet within the 45 days or within the mutually agreed to extension of time following receipt of a claim sent by registered mail or certified mail, return receipt requested, the public entity shall have up to three days following the next duly publicly noticed meeting of the governing body after the 45-day period, or extension, expires to provide the claimant a written statement identifying the disputed portion and the undisputed portion.

(D) Any payment due on an undisputed portion of the claim shall be processed and made within 60 days after the public entity issues its written statement. If the public entity fails to issue a written statement, paragraph (3) shall apply.

(2) (A) If the claimant disputes the public entity's written response, or if the public entity fails to respond to a claim issued pursuant to this section within the time prescribed, the claimant may demand in writing an informal conference to meet and confer for settlement of the issues in dispute. Upon receipt of a demand in writing sent by registered mail or certified mail, return receipt requested, the public entity shall schedule a meet and confer conference within 30 days for settlement of the dispute.

(B) Within 10 business days following the conclusion of the meet and confer conference, if the claim or any portion of the claim remains in dispute, the public entity shall provide the claimant a written statement identifying the portion of the claim that remains in dispute and the portion that is undisputed. Any payment due

Bid No. 2018-008

on an undisputed portion of the claim shall be processed and made within 60 days after the public entity issues its written statement. Any disputed portion of the claim, as identified by the contractor in writing, shall be submitted to nonbinding mediation, with the public entity and the claimant sharing the associated costs equally. The public entity and claimant shall mutually agree to a mediator within 10 business days after the disputed portion of the claim has been identified in writing. If the parties cannot agree upon a mediator, each party shall select a mediator and those mediators shall select a qualified neutral third party to mediate with regard to the disputed portion of the claim. Each party shall bear the fees and costs charged by its respective mediator in connection with the selection of the neutral mediator. If mediation is unsuccessful, the parts of the claim remaining in dispute shall be subject to applicable procedures outside this section.

(C) For purposes of this section, mediation includes any nonbinding process, including, but not limited to, neutral evaluation or a dispute review board, in which an independent third party or board assists the parties in dispute resolution through negotiation or by issuance of an evaluation. Any mediation utilized shall conform to the timeframes in this section.

(D) Unless otherwise agreed to by the public entity and the contractor in writing, the mediation conducted pursuant to this section shall excuse any further obligation under Section 20104.4 to mediate after litigation has been commenced.

(E) This section does not preclude a public entity from requiring arbitration of disputes under private arbitration or the Public Works Contract Arbitration Program, if mediation under this section does not resolve the parties' dispute.

(3) Failure by the public entity to respond to a claim from a contractor within the time periods described in this subdivision or to otherwise meet the time requirements of this section shall result in the claim being deemed rejected in its entirety. A claim that is denied by reason of the public entity's failure to have responded to a claim, or its failure to otherwise meet the time requirements of this section, shall not constitute an adverse finding with regard to the merits of the claim or the responsibility or qualifications of the claimant.

(4) Amounts not paid in a timely manner as required by this section shall bear interest at 7 percent per annum.

(5) If a subcontractor or a lower tier subcontractor lacks legal standing to assert a claim against a public entity because privity of contract does not exist, the contractor may present to the public entity a claim on behalf of a subcontractor or lower tier subcontractor. A subcontractor may request in writing, either on his or her own behalf or on behalf of a lower tier subcontractor, that the contractor present a claim for work which was performed by the subcontractor or by a lower tier subcontractor on behalf of the subcontractor. The subcontractor requesting that the claim be presented to the public entity shall furnish reasonable documentation to support the claim. Within 45 days of receipt of this written request, the contractor shall notify the subcontractor in writing as to whether the contractor presented the claim to the public entity and, if the original contractor did not present the claim, provide the subcontractor with a statement of the reasons for not having done so.

(e) The text of this section or a summary of it shall be set forth in the plans or specifications for any public works project that may give rise to a claim under this section.

Bid No. 2018-008

(f) A waiver of the rights granted by this section is void and contrary to public policy, provided, however, that (1) upon receipt of a claim, the parties may mutually agree to waive, in writing, mediation and proceed directly to the commencement of a civil action or binding arbitration, as applicable; and (2) a public entity may prescribe reasonable change order, claim, and dispute resolution procedures and requirements in addition to the provisions of this section, so long as the contractual provisions do not conflict with or otherwise impair the timeframes and procedures set forth in this section.

(g) This section applies to contracts entered into on or after January 1, 2017.

(h) Nothing in this section shall impose liability upon a public entity that makes loans or grants available through a competitive application process, for the failure of an awardee to meet its contractual obligations.

(i) This section shall remain in effect only until January 1, 2020, and as of that date is repealed, unless a later enacted statute, that is enacted before January 1, 2020, deletes or extends that date.

SEC. 2. The Legislature finds and declares that it is of statewide concern to require a charter city, charter county, or charter city and county to follow a prescribed claims resolution process to ensure there are uniform and equitable procurement practices.

SEC. 3. If the Commission on State Mandates determines that this act contains costs mandated by the state, reimbursement to local agencies and school districts for those costs shall be made pursuant to Part 7 (commencing with Section 17500) of Division 4 of Title 2 of the Government Code.

AGENCY SPECIAL PROVISIONS

PART 1

GENERAL PROVISIONS 0701

Attachment: Special Provisions PCS HSG GR-JFK RENO (2845 : APPROVE AND EXECUTE AGREEMENT FOR THE INSTALLATION OF A

SECTION 1 – TERMS, DEFINITIONS, ABBREVIATIONS, UNITS OF MEASURE, AND SYMBOLS

1-1.1 GENERAL

The Work shall be performed in accordance with the Special Provisions which amend, modify, and/or supplement Sections 1 through 800 of the latest edition of the “Greenbook,” Standard Specifications for Public Works Construction (including all supplement amendments), in effect and published at the Bid Deadline.

1-2 TERMS AND DEFINITIONS

Add the following:

| <u>WORD or WORDS</u> | <u>DEFINITION</u> |
|------------------------------------|--|
| Admitted | Entitled to transact insurance business in California (CCP995.120). |
| Agency | The City of Moreno Valley and the City of Moreno Valley Community Services District (CSD). |
| Alternate Bid, Alternate Bid Price | The amount stated in the Bid for which the Bidder offers to perform the Work described in the Bidding Documents as Alternate Work, to be added or deducted from the Base Bid , which shall be the Contractor’s responsibility if the Agency accepts the Alternate Bid Item. |
| Applicable Law | All state, federal, and local laws, statutes, ordinances, codes, rules, and regulations governing the Work. |
| Base Bid, Base Bid Price | The amount stated in the Bid for which the Bidder offers to perform the Work described in the Bidding Documents as the base Contract Work (i.e. not including Alternate Bid Items). |
| Bidding Documents | The proposed Contract Documents and Bidding Requirements prepared by the Agency for bidding. |
| Bidding Requirements | The Notice Inviting Bids, Instructions to Bidders, Bidder’s Proposal, Subcontractor Listing, Bidder’s Bond, and Contractor’s Statement. |
| Bid Item | An item of Work listed on the Bid Schedule. |
| Board | The City Council of the City of Moreno Valley, which is the awarding authority of the City. |

| <u>WORD or WORDS</u> | <u>DEFINITION</u> |
|-------------------------------|---|
| CA Building Code | The latest edition adopted by the City of Moreno Valley of the <u>CALIFORNIA BUILDING CODE</u> , as published by the International Conference of Building Officials, 5360 South Workman Mill Road, Whittier, California 90601. Builders Books, Inc., 7943 Canoga Avenue, Canoga Park, California 91304, Telephone 1-800-273-7375. The Agency does not endorse any bookstore, but has provided a source where the information may be obtained. |
| CA Electrical Code | The latest edition adopted by the City of Moreno Valley of the CALIFORNIA ELECTRICAL CODE BASED ON THE LATEST EDITION OF THE NATIONAL ELECTRICAL CODE as developed by the National Fire Protection Association, 1 Batterymarch Park, P.O. Box 9101, Quincy, MA 02269-9101. |
| CA Fire Code | The latest edition adopted by the City of Moreno Valley of the <u>CALIFORNIA FIRE CODE</u> , as published by the International Conference of Building Officials, 5360 South Workman Mill Road, Whittier, California 90601, and Western Fire Chiefs Association, Palm Brook Corporate Center, 3602 Inland Empire Boulevard, Suite B-205, Ontario, California 90601. |
| CA Mechanical Code | The latest edition adopted by the City of Moreno Valley of the <u>CALIFORNIA MECHANICAL CODE</u> , as published by the International Association of Plumbing and Mechanical Officials. |
| CA Plumbing Code | The latest edition adopted by the City of Moreno Valley of the <u>CALIFORNIA PLUMBING CODE</u> , as published by the International Association of Plumbing and Mechanical Officials. |
| Calendar Day | 24 hours beginning at 12 midnight and ending at 11:59 p.m. |
| Change Order | A written instrument prepared by the Agency and signed by the Agency and the Contractor, stating their agreement upon all of the following: (1) the scope of the change in the Work; (2) the amount of the adjustment, if any, in the Contract Price; and (3) the extent of the adjustment, if any, in the Contract Time. See Subsection 3-2.1.1 of the Special Provisions. |
| Change Order Proposal Request | A request issued by the Agency to the Contractor that describes a proposed change to the Work and requests that the Contractor submit an itemized Change Order Proposal to the Agency. See Subsection 3-2.1 of the Special Provisions. |
| City | The City of Moreno Valley. |

| <u>WORD or WORDS</u> | <u>DEFINITION</u> |
|-----------------------------|---|
| City Council | The City Council of the City of Moreno Valley. |
| Special Provisions | Provisions of the Agency that amend, modify, and/or supplement Sections 1 through 800 of the latest edition of the "Greenbook," Standard Specifications for Public Works Construction (including all supplement amendments), in effect and published at the Bid Deadline. |
| Construction | A written order prepared and signed by the Agency, directing a change in the Work prior to the Contractor's agreement on adjustment, if any, in the Contract Price or Contract Time, or both. See Subsection 3-2.1.2 of the Special Provisions. |
| Change Directive | |
| Contract Documents | The Contract Documents are enumerated in the Agreement. |
| Contract Time | The number of Working Days stated in the Agreement for the completion of the Work. |
| Contractor's Representative | See Subsection 7-6 of the Special Provisions. |
| CSD | Community Services District of the City of Moreno Valley |
| Detour | A temporary route for traffic (vehicular or pedestrian) around a closed portion of a road or travelway. |
| Director | Director of Parks and Community Services Department |
| District | The Riverside County Flood Control & Water Conservation District (RCFC&WCD) |
| Drawings or Plans | The part of the Contract Documents which show the characteristics and scope of the Work to be performed, and which have been prepared or approved by the Engineer. |
| Engineer | The Director of Parks and Community Services or person(s) designated by the Director acting either directly or through authorized agents. |
| Estimated Quantities | The quantities Work anticipated to be performed, as set forth in the Bid Schedule, designated as units or a lump sum. |
| Excavation | Any operation in which earth, rock, or other material in the ground is moved, removed, or otherwise displaced by means of tools, equipment, or explosives in any of the following ways: grading, trenching, digging, ditching, drilling, augering, tunneling, scraping, cable or pipe plowing and driving, or any other way (CGC 4216). |

| <u>WORD or WORDS</u> | <u>DEFINITION</u> |
|--|--|
| Field Order | A written order effecting a change in the Work not involving an adjustment in the Contract Price or an extension of the Contract Time, issued by the Engineer to the Contractor during construction. |
| Final Acceptance | Final Acceptance (Final Acceptance of the Work) occurs when the Engineer determines that Final Completion (as defined in Subsection 9-3.1 of the Special Provisions) of the Work has been achieved and a Notice of Completion has been recorded with the County of Riverside by the Agency. The date of Final Acceptance is the date the Notice of Completion is recorded by the County of Riverside Recorder. |
| Final Completion | See Subsection 9-3.1 of the Special Provisions for the steps (1 and 2) necessary to achieve Final Completion. |
| Furlough Day | A day on which the Agency is closed for business for budget reasons. A Furlough Day may be a Working Day. |
| Geotechnical and/or Soils Engineer | The private consulting geotechnical engineer retained to perform soils material testing. |
| Hazardous Material | <p>(1) A substance or combination of substances, which because of its quantity, concentration, or physical, chemical or infectious characteristics, may either:</p> <p style="padding-left: 40px;">(a) Cause, or significantly contribute to an increase in mortality or an increase in serious irreversible or incapacitating reversible illness; or</p> <p style="padding-left: 40px;">(b) Pose a substantial present or potential hazard to human health or environment when improperly treated, stored, transported or disposed of or otherwise managed.</p> <p>(2) Unless expressly provided otherwise, the term "hazardous material" shall be understood to also include extremely hazardous material.</p> |
| Inspector | The representative of the Engineer who is assigned to inspect conformance of the work to the Plans and Specifications. |
| Laboratory | The designated laboratory authorized by the Agency to test materials and/or Work. |
| Labor Surcharge and Equipment Rental Rates | The latest edition in effect on the date the Work is performed. Published by the California Department of Transportation, Caltrans Publications, 1900 Royal Oaks Drive, Sacramento, California 95815. |

| <u>WORD or WORDS</u> | <u>DEFINITION</u> |
|---|--|
| Major Contract Bid Item | A Bid Item for which the Total Price is 10% or more of the Contract Price. |
| Manufacturer | A person, firm, or corporation that fabricates, processes, or creates materials or equipment to be incorporated into the Project from raw materials or component parts. |
| Minor Contract Bid Item | A Bid Item for which the Total Price is less than 10% of the Contract Price. |
| Notice of Completion | A notice executed by the Engineer and recorded with the County of Riverside Recorder that provides formal notice of the completion of Work and Final Acceptance by the Agency. The Notice of Completion contains the name and address of the Agency, name and address of the Contractor, description of the site sufficient for identification, including the street address of the site, if any, and date of Final Completion. The date of Final Acceptance is the date the Notice of Completion is recorded by the County of Riverside Recorder. |
| Notice to Proceed or Notice to Proceed with Construction | A written notice issued by the Agency to the Contractor that authorizes the Contractor to perform the Work. |
| Notice to Proceed to Fulfill Preconstruction Requirements and/or Order of Materials | A written notice issued by the Agency to the Contractor that authorizes the Contractor to proceed with preconstruction requirements and the acquisition or purchase of materials that are to be incorporated into the Work and establishes the date of commencement of the Contract Time. |
| Owner | City of Moreno Valley unless otherwise specified. |
| Private Architect or Engineer | (If applicable) The private professional architect or consulting engineer who has prepared and signed the Plans. |
| Project | The total construction of which the Work performed under the Contract Documents may be the whole or a part and which may include construction by other contractors and the Agency's own forces. |
| Plans | The project drawings and details. |
| Project Manager | Parks Projects Coordinator or other assignee. |
| Punch List | A list of items of Work to be completed or corrected by the Contractor in order to complete the Work as specified in the Contract Documents. |

WORD or WORDSDEFINITION

| | |
|-------------------------|---|
| Registered Bidder | A Bidder that registers with the Agency by providing its street address, e-mail, phone, and fax to the Agency at the time of pick-up of or request for Bidding Documents. |
| Reference Documents | Drawings and documents showing existing site conditions or as-built improvements and made available to Bidders for general background information about the Project. No guarantee is made that existing improvements or site conditions are accurately shown or described on the Reference Documents. |
| Reference Specification | Any specifications referred to in the Bidding Documents other than Standard Specifications and Special Provisions, including, but not limited to bulletins, standards, rules, methods of analysis or tests, codes, State Standard Specifications, and specifications of other agencies, engineering societies, or industrial associations. These refer to the latest edition, including amendments, in effect and published at the Bid Deadline, unless otherwise specifically referred to by edition, volume, or date. |
| Shop Drawings | All drawings, diagrams, illustrations, brochures, schedules and other data which are prepared by the Contractor, a subcontractor, manufacturer, supplier, or distributor, which illustrate how specific portions of the Work shall be fabricated or installed. |
| Specifications | Standard Specifications, Reference Specifications, Special Provisions, and specifications in Addenda and Contract Change Orders. These refer to the latest edition, including amendments, in effect and published at the Bid Deadline unless otherwise specifically referred to by edition, volume, or date. |
| Standard Plans | Standard detail drawings and/or instructions of the Engineering Division of the Public Works Department of the City of Moreno Valley. Also referred to as Standard Drawings. |
| Standard Specifications | The latest edition of the "Greenbook," <u>Standard Specifications for Public Works Construction</u> , including all <u>Supplemental Amendments</u> , in effect and published at the Bid Deadline, otherwise specifically referred to by edition, volume, or date, prepared by Public Works Standards, Inc., as published by Building News, Inc., 990 Park Center Drive, Suite E, Vista, California 92801. Telephone No. 760.734.1113. |
| State | The State of California |

WORD or WORDS

DEFINITION

| | |
|-------------------------------|--|
| State Standard Plans | The latest edition of the Standard Plans of the State of California, Department of Transportation, including amendments, in effect and published at the Bid Deadline, unless otherwise specifically referred to by edition, volume, or date. |
| State Standard Specifications | The latest edition of the Standard Specifications of the State of California, Department of Transportation, in effect and published at the Bid Deadline, unless otherwise specifically referred to by edition, volume, or date. |
| Supplier | Any person or organization who supplies materials or equipment for the Work, including that fabricated to a special design, but who does not perform labor at the site. |
| Technical Provisions | Part of the Special Provisions consisting of a written description of a technical nature of materials, equipment, construction system, standards, and workmanship, which amend, modify, or supplement Sections 1 through 800 of the latest edition of the "Greenbook," Standard Specifications for Public Works Construction (including all supplement amendments), in effect and published at the Bid Deadline, and other agency or utility specifications. |
| Transportation Division | A division within the City of Moreno Valley Department of Public Works that is assigned traffic-related matters. |
| Traffic Engineer | The representative of the City Engineer who is assigned traffic-related matters. |
| Work | The construction and services required by the Contract Documents, whether completed or partially completed, and includes all other labor, materials, equipment, services provided or to be provided by the Contractor to fulfill the Contractor's obligations. |
| Work Directive | A unilateral written order issued by the Agency directing the Contractor to continue performance of the Work or a disputed item of Work pending resolution of a claim or dispute concerning the scope of Work. |
| Working Day | See Subsection 6-7.2 of the Special Provisions. |

Attachment: Special Provisions PCS HSG GR-JFK RENO (2845 : APPROVE AND EXECUTE AGREEMENT FOR THE INSTALLATION OF A

WORD or WORDS

DEFINITION

Written Notice

A notice in writing required under the Contract Documents. Written Notice is deemed delivered and the service thereof completed, when: (1) posted by certified or registered U.S. Mail, return receipt requested, to the appropriate party at its last given address, or (2) delivered in person to said party or its authorized representative at the worksite.

1-3

ABBREVIATIONS

1-3.2

Common Usage

Add the following to Subsection 1-3.2:

Abbreviation

Word or Words

| | |
|----------|---|
| ADA | Americans with Disabilities Act |
| AWG | American Wire Gage |
| B&P | Business and Professions Code |
| CA | California Administration Code |
| CA MUTCD | California Manual on Uniform Traffic Control Devices |
| CBC | California Building Code as amended by Title 8 of the City's Municipal Code |
| CC | Civil Code Section No. |
| CGC | California Government Code |
| CCP | California Code of Civil Procedure Section No. |
| CVC | California Vehicle Code |
| DBE | Disadvantaged Business Enterprise |
| EDC | Educational Code Section No. |
| IC | California Insurance Code Section No. |
| LC | Labor Code Section No. |
| MOU | Memorandum of Understanding – Riverside County Transportation Department and Riverside County Flood Control and Water Conservation District for Design, Construction, Inspection and Maintenance of Flood Control Drainage Facilities (June 2008) |
| NEC | National Electrical Code |
| PCC | Public Contract Code |
| PS & E | Plans Specifications and Estimates |
| RFI | Request for Information |

1-3.3 Institutions

Add the following to Subsection 1-3.3:

Abbreviation

Word or Words

| | |
|------|--|
| AAN | American Association of Nurserymen |
| ACI | American Concrete Institute |
| AGA | American Gas Association |
| AI | The Asphalt Institute |
| AIA | American Institute of Architects |
| AIEE | American Institute of Electrical Engineers |

| | |
|---------------|--|
| AISI | American Iron & Steel Institute |
| ANSI | United States of America Standards Institute |
| APHA | American Public Health Association |
| APWA | American Public Works Association |
| ASA | American Standards Association (now ANSI) |
| ASCE | American Society of Civil Engineers |
| ASHRAE | American Society of Heating, Refrigerating, and Air Conditioning Engineers |
| ASME | American Society of Mechanical Engineers |
| CRSI | Concrete Reinforcing Steel Institute |
| CSD | Community Services District of the City of Moreno Valley |
| EIA | Electronic Industries Association |
| EMWD | Eastern Municipal Water District |
| IEEE | Institute of Electrical and Electronics Engineers |
| MVHA | Moreno Valley Housing Authority |
| NBFU | National Board of Fire Underwriters |
| OSA | Office of State Architect |
| PCA | Portland Cement Association |
| RCFC & WCD | Riverside County Flood Control and Water Conservation District |
| RCTC | Riverside County Transportation Commission |
| RTA | Riverside Transportation Authority |
| SSPC | Steel Structures Painting Council |
| USASI or USAS | United States of America Standards Institute (Now ANSI) |
| WMWD | Western Municipal Water District |
| WRCOG | Western Riverside Council of Governments |

1-4.2 Units of Measure and Their Abbreviations

Add the following to Subsection 1-4.2:

| | |
|--------------|-----------|
| 1 Acre | 43,560 sf |
| Cubic Yards | CY |
| Each | EA |
| Feet | FT |
| Linear Feet | LF |
| Lump Sum | LS |
| Square Feet | SF |
| Square Yards | SY |
| Ton | TN |

SECTION 2 – SCOPE AND CONTROL OF WORK

2-1 AWARD AND EXECUTION OF CONTRACT

Delete Subsection 2-1 in its entirety. See the Instructions to Bidders.

2-2 ASSIGNMENT

2-2.1 Contractor Indebtedness. Indebtedness incurred by or on behalf of the Contractor for any reason in connection with the Work must be paid by the Contractor. The City, the Moreno Valley Housing Authority (MVHA), and the Moreno Valley Community Services District (CSD), have no obligation for any indebtedness or claim other than payments under terms of the Contract, and the Contractor shall not represent that it has any authority to create such an obligation on behalf of the City of Moreno Valley, the MVHA, or the CSD. The Contractor shall indemnify and hold harmless the City of Moreno Valley, the MVHA, and the CSD, its officers, employees and agents from any loss, demand, damages, claims or actions arising from or in connection with said indebtedness.

2-3 SUBCONTRACTS

2-3.1 General

Add the following at the end of Subsection 2-3.1:

Pursuant to Labor Code Section 1777.1, the Labor Commissioner publishes and distributes a list of contractors ineligible to perform work as a subcontractor on a public works project. This list of debarred contractors is available from the Department of Industrial Relations website at http://www.dir.ca.gov/dir/Labor_law/DLSE/Debar.html.

All subcontracts shall include a provision that requires each subcontractor, to the extent of the Work to be performed by each subcontractor, to be bound to the Contractor by the terms of the Contract Documents, and to assume toward the Contractor all of the obligations and responsibilities that the Contractor assumes toward the Agency. Each subcontract agreement shall preserve and protect the rights of the Agency under the Contract Documents with respect to the Work to be performed by each subcontractor so that subcontracting thereof will not prejudice such rights, and shall allow to each subcontractor, unless specifically provided otherwise in the subcontract agreement, the benefit of all rights, remedies and redress against the Contractor that the Contractor, by the Contract Documents, has against the Agency. Where appropriate, the Contractor shall require each subcontractor to enter into similar agreements with sub-subcontractors. The Contractor shall make available to each proposed subcontractor, prior to the execution of the subcontract agreement, copies of the Contract Documents to which the subcontractor shall be bound by this subsection of the Standard Specifications and the Agency's Special Provisions. If any provision of any subcontract is inconsistent with any provision of the Contract Documents or the intent of the Contract Documents, then the Contract Documents shall control.

Subcontracts shall also contain certification by the subcontractors that said subcontractor is experienced in and qualified to do, and knowledgeable about, the subcontracted Work. Copies of subcontracts shall be provided to the Engineer upon request.

2-3.2 Self Performance

Add the following at the end of Subsection 2-3.2:

Any Bid that does not indicate that Work valued at least fifty-one percent (51%) of the Contract Price (except Specialty Items) will be performed by the Bidder's own forces, will be considered non-responsive and will be rejected with no further consideration. If, after execution of the Agreement, the 's discovers the Contractor is performing Work valued at less than fifty percent (51%) of the Contract Price (except Specialty Items), the Contractor will be notified that it is in breach of the Contract. The Contractor's obligation to self-perform at least fifty percent (51%) of the Contract Price (except Specialty Items) is not subject to Change Orders that increase the value of subcontracted items of Work.

2-3.3 Status of Subcontractors

Add the following at the end of Subsection 2-3.3:

The Contractor shall be as fully responsible to the Agency for the acts and omissions of subcontractors and of persons employed by them as the Contractor is for the acts and omissions of persons directly employed by the Contractor. The Contractor shall be responsible for the coordination of the trades, subcontractors, and material suppliers engaged upon their Work. Neither the Agency nor any representative of the Agency will undertake to settle any difference between the Contractor and subcontractors or between subcontractors.

2-4 CONTRACT BONDS

Delete Subsection 2-4 in its entirety. See Paragraph HHH of the Agreement.

2-5 PLANS AND SPECIFICATIONS**2-5.1 General**

Add the following at the end of Subsection 2-5.1:

2-5.1.1 Standard Specifications

Except as otherwise specified on the Plans or in these Special Provisions, all Work shall be in accordance with the Standard Specifications. Any reference to "Section" or "Subsection" in these Special Provisions shall refer to said Standard Specifications unless noted otherwise.

2-5.3 Submittals**2-5.3.1 General**

Add the following at the end of Subsection 2-5.3.1:

As specified in Section 5 of the Agreement, the Contractor shall, at its own expense, transmit to the Engineer for review and acceptance, working drawings, shop drawings, supporting information, and/or other available instructive and descriptive information from the manufacturer, when and as required by the Plans or these Special Provisions or requested by the Engineer. Shop drawings will not be required for standard items in common use for which adequate manufacturers' literature is available unless otherwise required by the Engineer.

The Contractor shall consecutively number, thoroughly check, approve and sign each submittal and transmit the submittals to the Engineer for review. In the event that certain submittals are submitted without the Contractor's approval signature or are unacceptable to the

Agency, they shall be rejected by the Engineer. The Contractor shall thereafter correct said submittals and resubmit.

In the event that in the process of development of the submittals it is discovered that there are defects and/or errors on the Plans that result in conflict between said Plans and the submittals, or if the submittals show variation from the Plans or other Contract Documents because of standard shop practice or other reasons, the Contractor shall thoroughly describe and explain said defects and/or conflicts in his or her transmittal letter to the Engineer.

The Engineer's review of the submittals will be for general design and arrangement only, and shall not relieve the Contractor from responsibility for errors of any sort in the submittals or of the responsibility for executing the work in accordance with the Contract Documents. The Contractor shall be solely responsible for the correctness of the submittals, for shop fits and field connections, and for the results obtained by use of such submittals. The Contractor shall verify and be fully responsible for all dimensions and job-site conditions affecting the Work and shall be responsible for furnishing and installing the proper materials required by the Contract Documents.

The Contract Time will not be extended due to the failure of the Contractor to provide submittals as required by the Contract Documents in a timely manner.

2-9 SURVEYING

2-9.2 Survey Service

Add the following at the end of Subsection 2-9.2:

The Contractor shall preserve bench marks, survey monuments, survey stakes and points set for lines, grades or measurements of Work in their proper places unless removal is authorized by the Engineer. The Agency shall bear the cost of one (1) set of construction stakes and shall give a copy of the cut sheets to the Contractor. The cost of restaking due to the negligence of the Contractor will be deducted from the Contract Price via Change Order.

The cost of rework surveying, overtime, travel and other related costs incurred by the Agency will be deducted from the Contractor's progress payments.

2.11 INSPECTION

Add the following at the end of Subsection 2-11:

Should the Contractor elect to continue construction after a Stop Work Notice is issued, the Agency shall reject all work completed after the Stop Work Noticed issuance and the Agency will not be responsible for payment of the work; and/or the Agency shall require the Contractor to remove and replace all work completed, fully at the Contractor's cost after the Stop Work Notice issuance.

Inspection of the Work shall not relieve the Contractor of any of his obligations to fulfill the Contract. The Engineer shall have authority to stop Work whenever provisions of Contract Documents are not being complied with and such noncompliance is discovered. The Contractor shall remedy defective Work and the Agency may reject unsuitable materials, even if such defective Work or materials have been previously approved by the Engineer or included in the

quantities for progress payments. The Inspector cannot authorize deviations from the Plans and Specifications, and does not have the authority to obligate the Agency financially.

If any Work is concealed or performed without the requisite inspection notice, then the Work shall be subject to such tests or exposure as may be necessary to prove to the Engineer that the materials used and the Work performed are in conformity with the Plans and Specifications, or said materials or Work may be removed and installed or performed again at the discretion of the Agency Engineer. All labor, equipment, and materials necessary for exposing, testing, or complete removal, and installation or replacement shall be furnished by the Contractor at its own expense. The Contractor shall replace, at its own expense, any materials or Work damaged by exposure or testing.

Cost of rework inspection incurred by the Agency will be deducted from the Contract Price via Change Order. Rework inspection cost is as follows:

1. The Contractor's failure to complete the Work within the Contract Time, including any previously authorized extensions thereof.
2. Extra inspections required for the Contractor's correction of defective Work.
3. Overtime costs for acceleration of work done for the Contractor's convenience.
4. All associated costs including travel.

SECTION 3 – CHANGES IN WORK

3-1 CHANGES REQUESTED BY THE CONTRACTOR

3-1.1 General

Add the following at the end of Subsection 3-1.1:

If the Contractor alleges that instructions issued after the date of the Contract will result in increases to the Contract Price or Contract Time, if latent or unforeseen conditions require modification of the Contract Documents, or the Contractor otherwise becomes aware of the need for or desirability of a change in the Work, a Change Order Proposal (“COP”) may be submitted to the Agency in writing, using the forms provided herein in Subsection 3-6.2 of the Special Provisions, and must specify the reasons for such change, including relevant circumstances and impacts on the construction schedule. The Contractor may request additional compensation and/or time through a COP but not for instances that occurred more than **ten (10) Calendar Days** prior to the COP. The Contractor’s failure to initiate a COP within such period shall be deemed a waiver of the right to adjustment of the Contract Price or the Contract Time for the alleged change. Any COP that is approved by the Agency will be incorporated in a Change Order or Construction Change Directive. If the Agency determines that the Work in question is not a change, the Owner shall issue a Work Directive, ordering the Contractor to proceed with the Work without delay. If the COP is denied but the Contractor believes that it does have merit, the Contractor may submit a claim to the Agency.

3-2 CHANGES INITIATED BY THE AGENCY

3-2.1 General

Add the following at the end of Subsection 3-2.1:

The Agency reserves the right to make changes in the Work, including the elimination of any Bid Item, after execution of the Contract and without invalidating the Contract by:

- A. Change Order approved by the City Council, Board, City Manager, Director, or Agency Engineer (dollar value of approval authority for each as per Agency policy); or
- B. Construction Change Directive approved by the City Council, Board, City Manager, Director, or Agency Engineer (dollar value of approval authority for each as per Agency policy);

A change that causes the total value of all changes to exceed the Contract contingency amount established at the time of award of the Contract must be approved by the Board. No payments in excess of the original Contract Price will be made until a Change Order is approved in the normal course of business. The Agency may, at any time, without notice to the Contractor’s surety(ies), order changes in the Work within the general scope of the Contract. Such changes in the Work shall not relieve or release the surety(ies) of its(their) obligations under the Performance and Payment Bonds issued for the Project. Changes in the Work made pursuant to this Article 3 shall in no way release any guarantee or warranty provided by the Contractor.

The Agency may issue a Change Order Proposal Request (“COPR”), in writing, to the Contractor, describing a proposed change to the Work and requesting that the Contractor submit an itemized Change Order Proposal (“COP”) to the Agency, using the forms provided herein in Subsection 3-6.2 of the Special Provisions, within **ten (10) Calendar Days** after the Agency’s issuance of the COPR. If the Contractor fails to submit a COP within such period of time, it shall be presumed that the change described in the Agency’s COPR will not result in an increase to the Contract Price or Contract Time and the change shall be performed by the Contractor without such increases. A COPR does not authorize the Contractor to commence performance of the changed work. The Contractor shall not perform any change until receipt of the Agency’s written approval. If the Agency approves the Contractor’s COP, Owner shall issue a Change Order or Construction Change Directive.

Whenever a change is pending, the Contractor shall notify the Agency if it is necessary to halt other Work in the area of the change that would be affected thereby, until such time as the change is authorized.

Any change to the Contract Price shall be in a sum mutually agreed to by the Contractor and the Agency, except that when, in the opinion of the Agency, such basis is not feasible, the change to the Contract Price shall be determined as provided for in Subsection 3-3, “Extra Work,” of the Standard Specifications and the Special Provisions.

3-2.1.1 Change Order

A Change Order is a written instrument prepared by the Agency and signed by the Agency and the Contractor, stating their agreement upon all of the following:

- A. The scope of the change in the Work;
- B. The amount of the adjustment, if any, in the Contract Price; and
- C. The extent of the adjustment, if any, in the Contract Time.

3-2.1.1.1 Accord and Satisfaction

The Contractor’s agreement on any Change Order shall be a full compromise and settlement of all adjustments to the Contract Time and Contract Price, and compensation for any and all delay, extended or additional field and home office overhead, disruption, acceleration, inefficiencies, lost labor or equipment productivity, differing site conditions, construction interferences, and other extraordinary or consequential damages (hereinafter called “Impacts”), including any ripple or cumulative effect of said Impacts on the overall Work under the Contract arising directly or indirectly from the performance of Work described in the Change Order. By execution of any Change Order, The Contractor agrees that the Change Order constitutes a complete accord and satisfaction with respect to all claims for schedule extension, Impacts, or any costs of whatsoever nature, character or kind arising out of or incidental to the Change Order. No action, conduct, omission, product failure, or course of dealing by the Agency shall act to waive, modify, change, or alter the requirement that Change Orders must be in writing, signed by the Agency and the Contractor, and that such written Change Orders are the exclusive method for effectuating any change to the Contract Sum and/or Contract Time.

3-2.1.2 Construction Change Directive

A Construction Change Directive is a written order prepared and signed by the Agency, directing a change in the Work prior to the Contractor's agreement on adjustment, if any, in the Contract Price or Contract Time, or both. The Agency may by Construction Change Directive, without invalidating the Contract, order changes in the Work within the general scope of the Contract consisting of additions, deletions or other revisions, the Contract Price and Contract Time being adjusted accordingly. Upon receipt of a Construction Change Directive, the Contractor shall promptly proceed with the change in the Work involved. A Construction Change Directive shall be used in the absence of total agreement on the terms of a Change Order. The Agency's form of Construction Change directive is provided in Subsection 3-6.2 of the Special Provisions.

3-2.2.2 Increases of More than 25 Percent

Delete Subsection 3-2.2.2 in its entirety and substitute the following:

Should the actual quantity of a Major Item of Work covered by a Contract Unit Price and constructed in conformance with the Plans and Specifications exceed the Bid quantity by more than 25 percent, a Change Order will be issued and payment for the quantity in excess of 25 percent of the Bid quantity will be made on the basis of an adjustment to the Contract Unit price mutually agreed to by the Agency and the Contractor or pursuant to Subsection 3-2.4 "Agreed Prices."

For Minor Items of Work, the Contractor will be paid using the Contract Unit Price, regardless of whether the actual quantity of the Minor Item of Work covered by a Contract Unit Price exceeds the bid quantity by more than 25 percent.

3-2.2.3 Decreases of More than 25 Percent

Delete Subsection 3-2.2.3 in its entirety and substitute the following:

Should the actual quantity of a Major Item of Work covered by a Contract Unit Price and constructed in conformance with the Plans and Specifications be less than 75 percent of the Bid quantity, an adjustment in payment will not be made unless so requested in writing by the Contractor. If the Contractor so requests, a Change Order shall be issued and payment shall be made on the basis of an adjustment to the Contract Unit Price mutually agreed to by the Agency and the Contractor, or pursuant to Subsection 3-2.4 "Agreed Prices"; however, in no case will payment be less than would be made for the actual quantity at the Contract Unit Price.

For Minor Items of Work, the Contractor will be paid using the Contract Unit Price, regardless of whether the actual quantity of the Minor Item of Work covered by a Contract Unit Price is less than 75 percent of the Bid quantity.

3-2.2.4 Changes for Items Not Covered by Unit Prices

Payment for any change for an Item of Work not covered by a Contract Unit Price shall be made pursuant to Subsection 3-3 "Extra Work."

3-3 EXTRA WORK

3-3.1 General

Add the following at the end of Subsection 3-3.1:

The Contractor shall not perform any Extra Work except upon written authorization from the Engineer.

All Extra Work shall conform to the Plans and Specifications.

The Contractor shall furnish to the Engineer each subcontractor’s signed detailed estimate of the cost for labor, materials, and equipment, including the markup by such subcontractor for overhead and profit for Work added or deducted to a subcontractor’s scope of Work. The Contractor shall furnish to the Engineer the Sub-subcontractor’s signed detailed estimate of the cost for labor, materials, and equipment, including the markup by such sub-subcontractor for overhead and profit for Work added or deducted to a sub-subcontractor’s scope of Work. The Contractor shall furnish to the Engineer the vendor or supplier’s signed detailed estimate or quotation of the cost to the Contractor for Work added or deducted from a vendor or supplier’s scope of Work.

3-3.2.1 General

Add the following at the end of Subsection 3-3.2.1

Any change in the Work for an Item of Work not covered by a Contract Unit Price that involves both added and deleted Work shall be paid on the basis of the net total cost. The cost of deleted Work not covered by a Contract Unit Price shall be determined by the Engineer based on the schedule of lump sum prices submitted by the Contractor in accordance with Subsection 9-2, “Lump Sum Work,” of the Standard Specifications and the Special Provisions.

3-3.2.2.1 Labor

Delete Subsection 3-3.2.2.1 in its entirety and substitute the following:

The cost of labor will be the actual cost for wages prevailing locally for each craft or type of worker (including foreman when authorized by the Engineer) performing the Extra Work at the time the Extra Work is done, plus liability insurance, health and welfare, pension, vacation, apprenticeship funds, and other direct costs, as well as assessments or benefits required by lawful collective bargaining agreements.

To the actual wages, as defined above, will be added a labor surcharge set forth in the California Department of Transportation publication entitled “Labor Surcharge and Equipment Rental Rates” that is in effect on the date upon which the Extra Work is performed. The labor surcharge shall constitute full compensation for all payments imposed by State and federal laws and for all other payments made to, or on behalf of, the workers, other than actual wages, subsistence and travel paid to the workers. The labor surcharge includes Workers’ Compensation, Social Security, Medicare, Federal Unemployment, State Unemployment, and State Training taxes.

Except when direct supervision is provided by working foremen whose time is included in accordance with Subsection 3-2.2.2, the cost of direct supervision of Extra Work, when such direct supervision is provided exclusively for the Extra Work and not in conjunction with or at the

same time as supervision for other Work, and when approved in advance in writing by the Engineer, may be charged to the Extra Work. Such cost includes only the actual cost of supervision labor, plus payroll taxes, insurance, and pension costs. The cost of transportation, use of vehicle, and other costs incurred by supervision will not be allowed.

3-3.2.2.2 Materials

Add the following to Subsection 3-3.2.2.2:

If the Contractor does not furnish satisfactory evidence of the cost of the materials from the actual supplier thereof within a specified time period after the date of delivery of material, the Engineer reserves the right to establish the cost of the materials at the lowest current wholesale prices at which the materials were available, in the quantities concerned, delivered to the location of the Work site, less any discounts.

3-3.2.2.3 Tool and Equipment Rental

Delete Subsection 3-3.2.2.3 in its entirety and substitute the following:

No payment will be made for individual pieces of equipment or tools not listed in the California Department of Transportation publication entitled "Labor Surcharge and Equipment Rental Rates" that is in effect on the date upon which the Extra Work is performed and that have a replacement value of \$200 or less, whether or not consumed by use. Such equipment or tools shall be considered to be small tools.

The Contractor will be paid for the use of equipment at the rental rates listed for such equipment in the Labor Surcharge and Equipment Rental Rates publication that is in effect on the date upon which the Extra Work is performed.

Move in and out, or minimum charges other than the hourly rate, shall not apply to equipment available from the force already on the Project site.

For equipment that is rented from a local equipment agency, the Contractor will be paid at the hourly rate shown on the rental agency invoice or agreement for the time the equipment is used on Extra Work. If a minimum equipment rental amount is required by the local equipment rental agency, the actual amount charged will be paid to the Contractor.

If it is deemed necessary by the Engineer to use equipment not listed in the Labor Surcharge and Equipment Rental Rates publication, a suitable rental rate for that equipment will be established by the Engineer. The Contractor may furnish any cost data that might assist the Engineer in the establishment of the rental rate. If the rental rate established by the Engineer is \$10.00 per hour or less, the provisions above concerning rental of equipment from a local equipment agency shall apply.

Rental time will not be allowed while equipment is inoperative due to breakdowns.

When owner operated equipment is used to perform Extra Work to be paid on a force account basis, the Contractor will be paid for the equipment and operator as follows:

1. Payment for the equipment will be made at the rental rates listed for such equipment in the Labor Surcharge and Equipment Rental Rates publication that is in effect on the date upon which the Extra Work is performed.

2. Payment for the cost of labor will be made in conformance with the provisions in Subsection 3-3.2.2.1 "Labor" of the Special Provisions.

3-3.2.3 Markup

Delete Subsection 3-3.2.3 in its entirety and substitute the following:

The markup for overhead and profit on Extra Work shall be in accordance with the following schedule.

3-3.2.3.1 Work by Contractor. For Extra Work performed by the Contractor's forces, the following percentages shall be added to the Contractor's costs and shall constitute the markup for all overhead and profit: twenty percent (20%) for labor, fifteen percent (15%) for materials, and fifteen percent (15%) for equipment rentals.

3-3.2.3.2 Work by Subcontractor. For Extra Work performed by a subcontractor, the markup established in Subsection 3-3.2.3.1 of the Special Provisions shall be applied to the subcontractor's costs. An additional five percent (5%) shall be added to the subcontractor's final cost, which shall reimburse the Contractor for administrative costs, including overhead and profit.

3-3.2.3.3 Work by sub-subcontractor. For Extra Work performed by a sub-subcontractor, the markup established in Subsection 3-3.2.3.1 of the Special Provisions shall be applied to the sub-subcontractor's costs. An additional ten percent (10%) shall be added to the sub-subcontractor's final cost, five percent (5%) of which shall reimburse the Contractor for administrative costs, including overhead and profit, and five percent (5%) of which shall reimburse the subcontractor for administrative costs, including overhead and profit.

3-3.2.3.4 Work by Specialist. If the Engineer and the Contractor agree that a service or an item of Extra Work cannot be performed by the forces of the Contractor or those of any of its subcontractors or sub-subcontractors, such service or Extra Work item may be performed by a specialist. Invoices for such services or items of Extra Work calculated on the basis of current market prices may be accepted without complete itemization of labor, material, and equipment rental costs when it is impracticable and not in accordance with the established practice of the special service industry to provide such complete itemization.

If the Contractor is required to perform Extra Work that requires a fabrication or matching process in a fabrication or machine shop facilities away from the Project site, the charges for that portion of the Extra Work performed in such facility may, by agreement between the Contractor and Engineer, be accepted as a specialist billing.

For Extra Work performed by a specialist, fifteen percent (15%) shall be added to the specialist's invoice price less a credit to the Agency for any cash or trade discount offered or available, whether or not such discount may have been taken;

such percentage shall reimburse the Contractor for administrative costs, including overhead and profit.

3-3.2.3.5 Work not Covered by Unit Prices. Markup for overhead and profit on any change in the Work for an Item of Work not covered by a Contract Unit Price that involves both added and deleted Work shall be paid, in accordance with this Subsection 3-3.2.3 of the Special Provisions, only if the net cost increases the Contract Price (i.e. if the cost for added Work exceeds the cost for deleted Work).

3-3.3 Daily Reports by Contractor

Delete the first sentence of Subsection 3-3.3 and substitute the following:

The Contractor shall submit daily reports for Extra Work showing all labor, material, and equipment costs incurred.

Add the following at the end of Subsection 3-3.3:

The daily reports shall describe in detail the Extra Work that was performed and the location (station, etc.). Separate daily reports shall be submitted for Extra Work that is performed for more than one location and for different tasks that are performed on the same day. Material charges shall be substantiated by valid copies of vendor's invoices. Such invoices shall be submitted with the daily reports, or if not available, they shall be submitted with subsequent daily reports. The Contractor shall maintain the Contractor's records in such a manner as to provide a clear accounting of the costs.

Upon completion of the Extra Work, the Contractor shall submit a summary of costs, including markup for overhead and profit. All costs shall be in accordance with Subsection 3-3.2, "Payment," of the Standard Specifications and the Special Provisions. The signature of the Agency's Inspector on a daily report shall indicate agreement with the information reflected therein, not that the Contractor is entitled to payment of the costs in the report. The Engineer shall review the daily reports. The Engineer shall compare Inspector's records with the completed daily reports furnished by the Contractor and make any necessary adjustments. When the daily reports are agreed upon and signed by both parties, said reports shall become the basis of payment for the Extra Work performed.

3-3.4 Extension of Time

If the Contractor is delayed in completing the Extra Work due to a change ordered by the Agency, the time for completion of Work will be extended for a period equal to the number of days by which the entire Project has been delayed because of such change. The Contractor will not be liable for liquidated damages for such period of time and shall have no claim for any additional compensation for any such delay except as otherwise provided in the Standard Specifications or Special Provisions.

3-5 DISPUTED WORK

Delete Subsection 3-5 in its entirety and substitute the following:

In the event of disputed Work, the Agency shall have the right to unilaterally issue a written Work Directive and Contractor shall continue performance pending resolution of the

dispute and shall maintain cost data described in Subsection 3-3 of the Standard Specifications and the Special Provisions. The Agency's form of Work Directive is provided in Subsection 3-6 of the Special Provisions. Payment shall be made for such disputed Work as is later determined by negotiation between the parties or as is fixed by a court of law.

3-6 FORMS

3-6.1 Change Order Form

3-6.2 Change Order Proposal Forms

- (a) Change Order Proposal Summary Report
- (b) Labor Cost Report
- (c) Labor Rates Report
- (d) Material Cost Report
- (e) Equipment Cost Report
- (f) Special Forces/Services Cost Report

3-6.3 Construction Change Directive Form

3-6.4 Work Directive Form

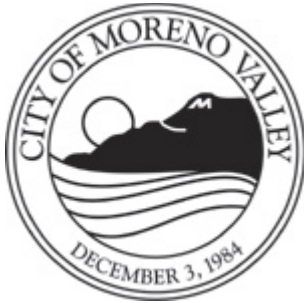

**CITY OF MORENO VALLEY
PARKS AND COMMUNITY SERVICES DEPARTMENT
Administration Division**

CONTRACT CHANGE ORDER NO. 1 (Final)

PROJECT NO.:

DESCRIPTION:

TO: **Construction Company, Inc.**

You are hereby requested to comply with the following changes from the Contract Plans and Specifications:

| SUMMARY OF CHANGES | |
|--|--|
| Description (Detailed Explanation Attached) | Change in Contract Price ¹ |
| 1. | \$0.00 |
| 2. Adjustment in Final Bid Quantities | \$0.00 |
| Net Change in Contract Price | |
| | \$0.00 |

¹ Deduction or decrease in Contract Price is denoted in parentheses

The following change is hereby made a part of the Contract Documents and shall be performed under the same terms and conditions as required by the original Contract Documents. Except as modified herein, the original Contract Documents and all prior amendments shall remain in full force and effect and all of the terms of the Contract Documents are hereby incorporated in this Change Order.

SUMMARY OF ALL CHANGE ORDERS

| | |
|--------------------------------|--------------|
| ORIGINAL CONTRACT AMOUNT | \$000,000.00 |
| CCO1 (FINAL) | \$0.00 |
| TOTAL | \$000,000.00 |

SUMMARY OF WORKING DAYS

FIRST DAY OF WORK:..... Date
 CONTRACT WORKING DAYS: X
 TIME EXTENSION:
 CCO 1 (Final)..... Y
 NEW TOTAL WORKING DAYS: X+Y
 LAST DAY OF WORK: New Date

SPECIAL PROVISIONS
PART 1 – GENERAL PROVISIONS
00701-23

Attachment: Special Provisions PCS HSG GR-JFK RENO (2845 : APPROVE AND EXECUTE AGREEMENT FOR THE INSTALLATION OF A

CHANGE ORDER DETAIL

Change Order No.: **1 (Final)**

Project No.:

Description:

The changes or interpretations described and noted herein are hereby authorized. The signed original of this order is on file in the Department of Public Works. Shown as separate paragraphs: (A) Reason for Change; (B) Description of Change; (C) Change in Contract Costs; and (D) Change in Completion Date.

Item No. 1:

A. Reason for Change:

B. Description of Change:

| ITEM | DESCRIPTION | UNIT | UNIT PRICE | BID OR CURRENT APPROVED QTY | FINAL QTY | CHANGE | CHANGE IN COST ¹ |
|----------|-------------|------|------------|-----------------------------|-----------|--------|-----------------------------|
| New Item | | | | 0 | 0 | 0 | 0.00 |

C. Change in Contract Cost:
Add \$0.00

D. Change in Completion Date:
Add Y Working Days

Item No. 2: Adjustment in Final Bid Quantities:

A. Reason for Change:
Due to conditions encountered during construction, modifications to the amount of Work were determined to be appropriate, and the changes were addressed by means of adjusting applicable contract quantities, as outlined below.

B. Description of Change:

| ITEM | DESCRIPTION | UNIT | UNIT PRICE | BID OR CURRENT APPROVED QTY | FINAL QTY | CHANGE | CHANGE IN COST ¹ |
|------|-------------|------|------------|-----------------------------|-----------|--------|-----------------------------|
| | | | | | | | |
| | | | | | | | |
| | | | | | | | |
| | | | | | | | |
| | | | | | | | |
| | | | | | | | |

¹Deduction or decrease in Contract Price is denoted in parentheses

C. Change in Contract Cost:
Add \$0.00

D. Change in Completion Date:
No Change.

SIGNATURE PAGE TO FOLLOW:

The original Contract Price was and 00/100 Dollars (\$0.00). Contract Change Order No.1 (Final) increased the Contract Price by 00/100 Dollars (\$0.00). The new Contract Price will be 00/100, resulting in an increase of approximately 0.00% to the original Contract.

The original Contract Time of X(x) Working Days was extended by Y (y) Working Days per Change Order No. 1 (Final). The last contract Working Day is new Date.

Ordered: _____ Date: _____
Director

Concurred by: _____ Date: _____
Project Manager

Acceptance by the Contractor:

This Change Order is in full compromise and settlement of all adjustments to Contract Time and Contract Price, and compensation for any and all delay, extended or additional field and home office overhead, disruption, acceleration, inefficiencies, lost labor or equipment productivity, differing site conditions, construction interferences and other extraordinary or consequential damages (hereinafter called "Impacts"), including any ripple or cumulative effect of said Impacts on the overall Work under the Contract arising directly or indirectly from the performance of Work described in this Change Order. By execution of this Change Order, the Contractor agrees that this Change Order constitutes a complete accord and satisfaction with respect to all claims for schedule extension, Impacts, or any costs of any nature, character or kind arising out of or incidental to this Change Order.

Name: _____ Date: _____

Title: _____

CHANGE ORDER PROPOSAL FORM

3-6.2(a) CONTRACT CHANGE ORDER PROPOSAL SUMMARY REPORT

Date _____

CCO Proposal No. _____

Contractor _____

Item No. _____

Location _____

AMOUNT

General Contractor

1. Labor Cost:..... \$ _____

2. Material Cost: \$ _____

3. Equipment Cost:..... \$ _____

4. Special Forces/Services: \$ _____

Subtotal Contractor Cost:..... \$ _____

5. Subcontractor/Sub-subcontractor Name _____

a. Labor Cost \$ _____

b. Material Cost..... \$ _____

c. Equipment Cost \$ _____

Subtotal Subcontractor/Sub-subcontractor Cost \$ _____

6. Subcontractor/Sub-subcontractor Name _____

a. Labor Cost \$ _____

b. Material Cost..... \$ _____

c. Equipment Cost \$ _____

Subtotal Subcontractor/Sub-subcontractor Cost \$ _____

TOTAL CONTRACT CHANGE ORDER COSTS \$ _____

CHANGE ORDER PROPOSAL FORM

3-6.2(b) LABOR COST REPORT

Date _____

CCO Proposal No. _____ Contractor or Subcontractor _____

Item No. _____ Location _____

| CLASSIFICATION AND NAME | HOURS | HOURLY RATE | EXTENDED AMOUNTS |
|-------------------------|-------|-------------|------------------|
| Classification: | OT | \$ | \$ |
| Name: | REG | \$ | \$ |
| Classification: | OT | \$ | \$ |
| Name: | REG | \$ | \$ |
| Classification: | OT | \$ | \$ |
| Name: | REG | \$ | \$ |
| Classification: | OT | \$ | \$ |
| Name: | REG | \$ | \$ |
| Classification: | OT | \$ | \$ |
| Name: | REG | \$ | \$ |
| TOTAL LABOR | | | \$ |

Overhead/profit 20%..... \$ _____

Total labor/overhead/profit \$ _____

Subcontractor's mark-up of total Sub-subcontractor
labor/overhead/profit (if applicable) 5%..... \$ _____

General contractor's mark-up of total Subcontractor
or Sub-subcontractor labor/overhead/profit (if applicable) 5%..... \$ _____

Total..... \$ _____

SPECIAL PROVISIONS
PART 1 – GENERAL PROVISIONS
00701-28

Attachment: Special Provisions PCS HSG GR-JFK RENO (2845 : APPROVE AND EXECUTE AGREEMENT FOR THE INSTALLATION OF A

CHANGE ORDER PROPOSAL FORM

3-6.2(c) LABOR RATES REPORT

Date _____

CCO Proposal No. _____ Contractor or Subcontractor _____

Item No. _____ Location _____

| CLASSIFICATION: | | |
|--|-----------|-----------|
| | | |
| TAXABLE BASE: | | AMOUNT |
| Base Hourly Pay | | \$ |
| Vacation | | \$ |
| TOTAL TAXABLE BASE | | \$ |
| TAXES & INSURANCE | PERCENT | AMOUNT |
| Social Security Tax | | \$ |
| State Unemployment Tax | | \$ |
| Federal Unemployment Tax | | \$ |
| Workmen's Compensation | | \$ |
| Liability & Umbrella Insurance | | \$ |
| TOTAL TAXES & INSURANCE | | \$ |
| FRINGE BENEFITS | AMOUNT | |
| Pension | \$ | |
| Health & Welfare | \$ | |
| Training | \$ | |
| Other Fringe Benefits | \$ | |
| TOTAL FRINGE BENEFITS | \$ | |
| TOTAL LABOR RATE PER CLASSIFICATION | \$ | |

SPECIAL PROVISIONS
PART 1 – GENERAL PROVISIONS
00701-29

Attachment: Special Provisions PCS HSG GR-JFK RENO (2845 : APPROVE AND EXECUTE AGREEMENT FOR THE INSTALLATION OF A

CHANGE ORDER PROPOSAL FORM

3-6.2(d) MATERIAL COST REPORT

Date _____

CCO Proposal No. _____ Contractor or Subcontractor _____

Item No. _____ Location _____

| INVOICE NO. | DESCRIPTION | AMOUNT |
|-------------------------------|---------------------------------------|----------|
| 1. | Material | \$ _____ |
| | Sales Tax (Prevailing Tax Rate) 7.75% | \$ _____ |
| Subtotal | | \$ _____ |
| 2. | Material | \$ _____ |
| | Sales Tax (Prevailing Tax Rate) 7.75% | \$ _____ |
| Subtotal | | \$ _____ |
| 3. | Material | \$ _____ |
| | Sales Tax (Prevailing Tax Rate) 7.75% | \$ _____ |
| Subtotal | | \$ _____ |
| SUBTOTAL MATERIAL COST | | \$ _____ |

NOTE: An itemized list of materials, manufacturers, serial numbers, invoices, and other pertinent date shall be submitted along with the material cost report.

Overhead/profit 15%..... \$ _____

Total material/overhead/profit \$ _____

Subcontractor's mark-up of total Sub-subcontractor material/overhead/profit (if applicable) 5%..... \$ _____

General contractor's mark-up of total Subcontractor or Sub-subcontractor material/overhead/profit (if applicable) 5%..... \$ _____

Total..... \$ _____

SPECIAL PROVISIONS
PART 1 – GENERAL PROVISIONS
00701-30

Attachment: Special Provisions PCS HSG GR-JFK RENO (2845 : APPROVE AND EXECUTE AGREEMENT FOR THE INSTALLATION OF A

CHANGE ORDER PROPOSAL FORM

3-6.2(e) EQUIPMENT COST REPORT

Date _____

CCO Proposal No. _____ Contractor or Subcontractor _____

Item No. _____ Location _____

3-6.2 (e) EQUIPMENT COST REPORT

| EQUIPMENT NO. (Description, Type, Size) | HOURS | HOURLY RATE | EXTENDED AMOUNTS |
|--|-------|----------------|---------------------|
| | | | |
| | | | |
| | | | |
| | | | |
| | | | |
| | | | |
| | | | |
| | | | |
| | | | |
| SUBTOTAL EQUIPMENT COST | | | \$ _____ |

Overhead/profit 15%..... \$ _____

Total equipment/overhead/profit \$ _____

Subcontractor's mark-up of total Sub-subcontractor
equipment/overhead/profit (if applicable) 5%..... \$ _____

General contractor's mark-up of total Subcontractor
or Sub-subcontractor equipment/overhead/profit (if applicable) 5% \$ _____

Total..... \$ _____

SPECIAL PROVISIONS
PART 1 – GENERAL PROVISIONS
00701-31

Attachment: Special Provisions PCS HSG GR-JFK RENO (2845 : APPROVE AND EXECUTE AGREEMENT FOR THE INSTALLATION OF A

CHANGE ORDER PROPOSAL FORM

3-6.2 (f) SPECIAL FORCES/SERVICES COST REPORT

Date _____

CCO Proposal No. _____ Contractor or Subcontractor _____

Item No. _____ Location _____

| INVOICE NO. | DESCRIPTION | AMOUNT |
|-------------------------------|-------------|--------|
| 1. | | \$ |
| | | \$ |
| Subtotal | | \$ |
| 2. | | \$ |
| | | \$ |
| Subtotal | | \$ |
| 3. | | \$ |
| | | \$ |
| Subtotal | | \$ |
| SUBTOTAL MATERIAL COST | | \$ |

NOTE: An itemized list of materials, manufacturers, serial numbers, invoices, and other pertinent data shall be submitted along with the special forces/services cost report.

Overhead/profit 15%..... \$ _____

Total Special Forces/Services Overhead/Profit..... \$ _____

SPECIAL PROVISIONS
PART 1 – GENERAL PROVISIONS
00701-32

Attachment: Special Provisions PCS HSG GR-JFK RENO (2845 : APPROVE AND EXECUTE AGREEMENT FOR THE INSTALLATION OF A

3-6.3 CONSTRUCTION CHANGE DIRECTIVE

Distribution to: OWNER CONTRACTOR OTHER PROJECT MANAGER

| | |
|-----------------------|-----------------------|
| PROJECT: | DIRECTIVE NO.: |
| | DATE: |
| | CONTRACT DATE: |
| TO CONTRACTOR: | CONTRACT FOR: |

You are hereby directed to make the following change(s) to this Contract:

PROPOSED ADJUSTMENTS

- The proposed basis of adjustment to the Contract Price is:
 - Lump Sum (increase) (decrease) of \$ _____.
 - Unit Price of \$ _____ per _____.
 - Daily time and materials records of actual costs plus a overhead and profit, as provided in **Subsection 3-3, "Extra Work," the Standard Specifications and the Agency's Special Provisions**, [subject to a Not-To-Exceed Amount of \$ _____].
 - as follows:
- The Contract Time is proposed to (be adjusted) (remain unchanged). The proposed adjustment, if any, is (an increase of ___ days) (a decrease of ___ days).

If the Contractor disagrees with the proposed adjustments, it must submit its own proposal within 10 days of the date of this Construction Change Directive pursuant to Contract Documents or the proposed adjustment will become final and binding on the Contractor.

When signed by the Agency's and received by the Contractor, this document becomes effective IMMEDIATELY as a Construction Change Directive (CCD), and the Contractor shall proceed with the change(s) described above.

| | |
|---------------------------------------|-------------|
| Ordered: _____ Director | Date: _____ |
| Concurred by: _____ Engineer | Date: _____ |
| Prepared by: _____ Project Manager | Date: _____ |

Attachment: Special Provisions PCS HSG GR-JFK RENO (2845 : APPROVE AND EXECUTE AGREEMENT FOR THE INSTALLATION OF A

3-6.4 WORK DIRECTIVE

Distribution to: OWNER CONTRACTOR FIELD OTHER PROJECT MANAGER

| | |
|----------------|---------------------|
| PROJECT: | WORK DIRECTIVE NO.: |
| | DATE: |
| | CONTRACT DATE: |
| TO CONTRACTOR: | CONTRACT FOR: |

You are hereby directed to continue performance of the following Work, without delay, pending resolution of the dispute concerning such Work and maintain the cost data described in Subsection 3-3, "Extra Work," of the Standard Specifications and the **Agency's Special Provisions** to the Contract for the performance of such Work:

Neither the issuance of this Work Directive nor the requirement for the Contractor to maintain cost data constitutes approval by the Agency of a change in the Work or modification of the Contract Documents.

Ordered: _____ Date: _____
Director

Concurred by: _____ Date: _____
Engineer

Prepared by: _____ Date: _____
Project Manager

Attachment: Special Provisions PCS HSG GR-JFK RENO (2845 : APPROVE AND EXECUTE AGREEMENT FOR THE INSTALLATION OF A

SECTION 4 - CONTROL OF MATERIALS

4-1 MATERIALS AND WORKMANSHIP

4-1.1.1 Property Rights in Materials

Nothing in the Contract shall be construed as vesting in the Contractor any right, title, or interest in material used in the Work after it has been attached or affixed to the Work or the soil. All such material shall become the property of the Agency upon being so attached or affixed.

4-1.2 Protection of Work and Materials

Add the following at the end of Subsection 4-1.2:

Materials shall not be stored in the right-of-way unless written permission is given by the Engineer.

4-1.4 Test of Materials

Delete Subsection 4-1.4 in its entirety and substitute the following:

Unless otherwise called for in these Special Provisions, all testing of materials will be performed by the Agency in such number and at such locations as deemed necessary by the Engineer to ensure compliance with the Contract Documents. The cost of all testing that can be performed within 50 miles of the Project will be borne by the Agency; the cost of all testing that must be performed 50 miles or more from the Project will be borne by the Contractor; the cost of all re-testing will be borne by the Contractor, and the amount due the Agency for said re-testing will be deducted from the Contract Price via Change Order.

The cost of rework material testing, overtime, travel and other related costs incurred by the Agency will be deducted from the Contract Price via Change Order.

4-1.5 Certificate of Compliance

Add the following at the end of Subsection 4-1.5:

A certificate of compliance shall be furnished prior to the use of any materials for which the Standard Specifications or Special Provisions require that a certificate be furnished. In addition, when so authorized in the Standard Specifications or Special Provisions, the Engineer may permit the use of certain materials or assemblies prior to sampling and testing if accompanied by a certificate of compliance. The certificate shall be signed by the manufacturer of the material or the manufacturer of assembled materials, and shall state that the materials involved comply in all respects with the requirements of the Specifications. A certificate of compliance shall be furnished with each lot of material delivered to the Project and each lot shall be clearly identified in the certificate.

All materials used on the basis of a certificate of compliance may be sampled and tested at any time. The fact that material is used on the basis of a certificate of compliance shall not relieve the Contractor of responsibility for incorporating material in the Work which conforms to the requirements of the Contract Documents, and any material not conforming to the requirements will be subject to rejection, whether in place or not.

The Agency reserves the right to refuse to permit the use of material on the basis of a certificate of compliance.

4-1.6 Trade Names or Equals

Add the following at the end of Subsection 4-1.6:

The phrase "or equal" shall mean "or approved as equal in the opinion of the Engineer."

Within ten (10) Working Days after the date of Contract award, the Contractor shall, at its expense, submit a written request to the Engineer for each desired substitution for final evaluation by the Engineer. Each substitution request shall be accompanied by complete descriptive information from the manufacturer, samples as requested by the Engineer, complete detailed test results from a licensed independent testing laboratory of the Agency's choice if requested by the Engineer, and, if requested by the Engineer, an evaluation report from a qualified licensed professional engineer. If, in the Engineer's opinion, the requested substitution is of lesser quality or in variance with that specified, or if the information submitted is insufficient or incomplete, the requested substitution will not be approved and the specified materials or equipment shall be furnished. No request for substitutions submitted more than ten (10) Working Days after the date of Contract award will be considered.

In accordance with Public Contract Code Section 3400, the Agency may describe in the Notice Inviting Bids a finding that a particular material, product, thing, or service is designated by specific brand or trade name for any of the following purposes:

- 1. In order that a field test or experiment may be made to determine the product's suitability for future use.
- 2. In order to match other products in use on a particular public improvement either completed or in the course of completion.
- 3. In order to obtain a necessary item that is only available from one source.
- 4. A. In order to respond to an emergency declared by a local agency, but only if the declaration is approved by a four-fifths vote of the City Council.
B. In order to respond to an emergency declared by the State, a State agency, or political subdivision of the State, but only if the facts setting forth the reasons for the finding of the emergency are contained in the public records of the City Council.

4-1.10 Foreign Materials

Materials which are manufactured, produced, or fabricated outside of the United States shall be delivered to a distribution point in California, unless otherwise required by the Standard Specifications or Special Provisions, where they shall be retained for a sufficient period of time to permit inspection, sampling, and testing.

The Contract Time shall not be extended due to acts or events occurring outside of the United States and it shall be the Contractor's responsibility to deliver materials obtained from outside of the United States to the point of entry into the continental United States in sufficient time to permit timely delivery to the Project site.

The cost of all testing that can be performed within 50 miles of the Project will be borne by the Agency; the cost of all testing that must be performed 50 miles or more from the Project will be borne by the Contractor; the cost of all re-testing will be borne by the Contractor, and the amount due the Agency for said re-testing will be deducted from the Contract Price via Change Order.

The manufacturer, producer, or fabricator of foreign material shall furnish to the Engineer a certificate of compliance in accordance with Subsection 4-1.5 of the Standard Specifications

and the Special Provisions. In addition, certified mill test reports or actual specimen tests clearly identifiable to the lot of material shall be furnished as required by the Standard Specifications or Special Provision, or as otherwise required by the Engineer.

If the welding of steel for structural steel members or the casting and prestressing of precast prestressed concrete members is to be performed outside of the United States, the following requirements shall apply:

- A. The fabrication shall be performed only within the plants and by fabricators who have previously established, to the satisfaction of the Engineer, that they have the experience, knowledge, trained manpower, quality controls, equipment and other facilities required to produce the quality and quantity of work required. At the option of the Engineer, prequalification of the plant and fabricator will be established either by the submission of detailed written proof thereof or through in-plant inspection by the Engineer or the Engineer's representative, or both.
- B. The Contractor shall make written application to the Engineer for approval for the foreign fabrication at the earliest possible time and in no case later than fifty (50) days in advance of the planned start of fabrication. The application shall list the specific units or portion of Work that will be fabricated outside of the United States.
- C. The Contractor shall advise the Engineer, in writing, at least twenty (20) days in advance of the actual start of any of the foreign fabrication.
- D. All documents pertaining to the foreign fabrication, including, but not limited to, correspondence, bids, proposals, working drawings, and data shall be written in the English language and all numerical data shall use the International System of Units (SI) for measurement.

4-1.11 State Specification Number

The State specification number of material furnished under the Contract shall conform to the number specified in the Standard Specifications, Special Provisions, or Specifications issued after the Standard Specifications and Special Provisions.

SECTION 5 – UTILITIES

5-1 LOCATION

Delete Subsection 5-1 in its entirety and substitute the following:

In accordance with California Government Code Section 4216 et seq., when Work is to be conducted in an area which is known, or reasonably known, to contain underground utilities or subsurface improvements, the Contractor shall contact Underground Service Alert of Southern California at least two (2) Working Days, but not more than 14 Calendar Days, in advance of any construction activity that will or could damage or affect any underground utility or subsurface improvement, and obtain an inquiry identification number (CGC 4216). The Contractor shall delineate with white paint or other suitable markings the area to be excavated. The Contractor shall notify Underground Service Alert in the event of change in the Project limits or change in original Work previously shown on the Plans or indicated in the Specifications. When all Work is completed, the Contractor shall remove all markings for underground utilities.

Subsurface installations are any underground pipeline, conduit, duct, wire, or other structure, except nonpressurized sewer lines, nonpressurized storm drains, or other nonpressurized drain lines. "Approximate location of subsurface installations" means a strip of land not more than 24 inches on either side of the exterior surface of the subsurface installation. "Approximate location" does not mean depth (CGC 4216). When the subsurface installation markings are no longer reasonably visible, the Contractor shall notify Underground Service Alert to remark those subsurface installations that may be affected by excavation to the extent necessary (CGC 4216.3(c)).

5-5 DELAYS

Add the following at the end of Subsection 5-5:

In accordance with California Government Code Section 4215, if such utilities have not been identified with reasonable accuracy in the Contract Documents, the Contractor shall be compensated for the cost of locating, repairing damage not due to the failure of the Contractor to exercise reasonable care, and removing or relocating such utility facilities not indicated in the Plans and Specifications with reasonable accuracy, and for equipment on the Project necessarily idled during such Work. The Contractor shall not be assessed liquidated damages for delay in completion of the Project, when such delay was caused by the failure of the Agency or the owner of the utility to provide for removal or relocation of such utility facilities.

5-7 AGENCY TELEPHONE NUMBERS

The following list of individuals or entities, which may have facilities in the area to be improved hereunder, is merely for the Contractor's information and may not be accurate or complete:

| | |
|--|--------------|
| Box Springs Mutual Water Company | 951.653.6419 |
| City of Moreno Valley Police Department | 951.486.6700 |
| City of Moreno Valley, Public Works Department | 951.413.3100 |
| City of Moreno Valley, PW Operations & Facilities | 951.413.3160 |
| City of Moreno Valley, Parks & Community Services | 951.413.3280 |
| City of Moreno Valley, Parks Maintenance | 951.413.3702 |
| Eastern Municipal Water District | 800.426.3693 |
| Egdemont Community Services District (Albert A. Webb & Assoc.) ... | 951.686.1070 |

| | |
|--|--------------|
| Moreno Valley Unified School District | 951.485.5600 |
| Moreno Valley Utilities (Electrical) | 877.811.8700 |
| Questar Southern Trails | 714.379.3376 |
| Riverside Transit Agency | 951.684.0850 |
| SBC (formerly Pacific Bell) | 800.750.2355 |
| Southern California Edison Company | 800.684.8123 |
| Southern California Gas Company (Distribution)..... | 909.335.3919 |
| Southern California Gas Company (Transmission) | 213.244.2268 |
| Sunesys | 951.278.0400 |
| Time Warner Communications..... | 951.549.3977 |
| Underground Service Alert..... | 800.227.2600 |
| United States Postal Service..... | 951.656.3240 |
| ValVerde Unified School District..... | 951.940.6100 |
| Frontier | 800.483.4000 |
| Waste Management..... | 800.423.9986 |
| Western Municipal Water District | 951.789.5109 |

5-8 SOUTHERN CALIFORNIA EDISON TEMPORARY ELECTRICAL SERVICE CONNECTION FOR CONSTRUCTION POWER

The Contractor shall apply for and pay all charges levied by Southern California Edison for rendering temporary electrical service to this Project. Charges can be obtained by contacting Southern California Edison, 26100 Menifee Road, Romoland, California 92585, Telephone 951.928.8288. The foregoing address and telephone number are for informational assistance only and may not be accurate or complete.

Attachment: Special Provisions PCS HSG GR-JFK RENO (2845 : APPROVE AND EXECUTE AGREEMENT FOR THE INSTALLATION OF A

SECTION 6 – PROSECUTION, PROGRESS, AND ACCEPTANCE OF THE WORK

6-1 CONSTRUCTION SCHEDULE AND COMMENCEMENT OF WORK

6.1.1 Construction Schedule

Delete the first sentence of Subsection 6.1.1 and substitute the following:

The Contractor shall submit a proposed construction schedule (Gant Chart) for the entire Work to the Engineer for review and approval five (5) Working Days prior to the pre-construction meeting and revised schedules thereafter as required by the Engineer when the Contractor's activities differ or are expected to differ from the latest existing schedule. If, on the date of commencement established in the Notice to Proceed, the Contractor has not submitted a construction schedule the Contractor will not be allowed to start Work and no extension of the Contract Time will be granted. The Contractor shall refer to the PROJECT SPECIFIC SCOPE OF WORK section in the Technical Provisions for any required or preferred sequence of Work.

Add the following at the end of Subsection 6.1.1:

The Contractor's Representative and the Contractor's principal subcontractors shall attend the Agency's pre-construction meeting. Other agencies and utilities involved in this Project may also have separate pre-construction meetings; the Contractor and applicable subcontractors are required to attend the agency/utility meetings.

6-1.2 Commencement of the Work

In the second sentence of Subsection 6-1.2, add the word "calendar" before the word "days."

6-3 SUSPENSION OF THE WORK

6-3.2 Archaeological and Paleontological Discoveries

Add the following at the end of Subsection 6-3.2:

During construction, if subsurface archaeological resources are encountered, they shall be left in place and a qualified archaeologist shall be called in to examine the findings. Work shall not resume, where discovery was made, until the archaeologist has reviewed the findings, made recommendations for their removal or preservation, and has a reasonable opportunity to carry out the necessary mitigation procedures. The Contract Time will be extended due to the discovery of subsurface archaeological resources only if the Contractor shows that there is no possible way to proceed with other Work items during the time Work was ceased pursuant to this Subsection of the Standard Specifications and the Special Provisions.

6-5 TERMINATION OF THE CONTRACT FOR CONVENIENCE

Delete Subsection 6-5 in its entirety and substitute the following:

6-5.1 Termination for Cause

6-5.1.1 Grounds. The Agency shall have the right to terminate the Contractor's performance of the Work, in whole or in part, if:

- A. The Contractor fails to promptly commence the Work or unnecessarily or unreasonably delays the Work or improperly discontinues the prosecution of the Work or abandons the Work;
- B. The Contractor refuses or fails to supply skilled supervisory personnel, an adequate number of properly skilled workers, proper materials, or necessary equipment to perform the Work in strict accordance with the Contract Documents, and the latest approved construction schedule;
- C. The Contractor fails to make prompt payment of amounts properly due subcontractors after receiving payment from the Agency;
- D. The Contractor disregards Applicable Law, statutes, ordinances, codes, rules, regulations, or lawful orders of a public authority;
- E. The Contractor fails to resume performance of Work which has been suspended or stopped, within a reasonable time after receipt of notice from the Agency to do so or (if applicable) after cessation of the event preventing performance;
- F. Any representation or warranty made by the Contractor in the Contract Documents or any certificate, schedule, instrument, or other document delivered by the Contractor pursuant to the Contract Documents shall have been false or materially misleading when made;
- G. After commencement of the Work, the Agency becomes aware that the Contractor is using an ineligible contractor, subcontractor or supplier who was barred from performing Work or providing materials or services on Agency projects at the time of Bid;
- H. The Contractor fails to make payment to subcontractors for materials or labor in accordance with the respective Contract Documents and Applicable Law;
- I. The Contract is assigned or the Work is sublet otherwise than as specified in the Contract Documents;
- J. The Contractor otherwise is guilty of breach of a provision of the Contract Documents; or
- K. The Contractor materially fails to execute the Work in accordance with the Contract Documents or, in the Agency's opinion, is violating any of the terms of the Contract or is not executing the Contract in good faith or is not following instructions of the Agency as to additional force necessary in the opinion of the Agency for completion of the Work within the required time.

When the Agency terminates the Contractor's performance of the Work for one of the reasons stated in this Subsection 6-5.1.1 of the Special Provisions, the Contractor shall not be entitled to receive further payment until the Work is finished by others in accordance with Subsection 6-5.1.2 of the Special Provisions.

6-5.1.2 Agency's Rights Upon Termination of Contract. When any of the reasons specified in Subsection 6-5.1.1 of the Special Provisions exist, the Agency may, in addition to and without prejudice to any other rights or remedies of the Agency, notify the Contractor not to resume or to discontinue all Work, or any part thereof, by written notice of default. The Agency shall advise the Performance Bond surety of the notice of default and that they will be given **fifteen (15) Calendar Days** to arrange for completion of the Work in accordance with the Contract Documents by another contractor or contractors satisfactory to the Agency. Should the surety fail to effect satisfactory arrangements within said 15-day period, the Agency shall have the right to issue a notice of termination and to:

- A. Exclude the Contractor from the Project site;

- B. Take possession of the Project site and of all materials, equipment, tools and construction equipment, and machinery thereon owned by the Contractor;
- C. Suspend any further payments to the Contractor;
- D. Accept assignment of Subcontracts pursuant; and
- E. Finish the Work by whatever reasonable method the Agency may deem expedient.

6-5.1.3 Cost of Completion of Work. The Agency shall charge the cost to complete the Work, including, but not limited to, protection, investigation, labor, services, equipment, materials, permits, fees, supervisory and administrative costs to the Contractor and its Performance Bond surety. If the unpaid balance of the Contract Price exceeds costs of finishing the Work, including expenses and damages incurred by the Owner and not expressly waived, such excess shall be paid to the Contractor. If Agency's cost to complete the Work and damages incurred by Agency due to the Contractor's default exceed the unpaid Contract Price, the Contractor and its Performance Bond surety shall pay the difference to the Agency.

6-5.1.4 Erroneous Termination. If it has been adjudicated or otherwise determined that the Agency has erroneously or negligently terminated the Contractor for cause, then said termination shall automatically convert to a termination by the Agency for convenience as set forth in Subsection 6-5.2 of the Special Provisions.

6-5.1.5 Acceptance of Incomplete or Non-Conforming Work. In lieu of the provisions of Subsection 6-5 of the Special Provisions for terminating the Contractor's performance, Owner may pay the Contractor for the portion of Work completed according to the provisions of the Contract Documents and may treat the incomplete Work as if they had never been included or contemplated by this Contract, in which case the Contract Price will be reduced by the value of the deleted Work determined in accordance with Section 3, "Changes in Work," of the Standard Specifications and the Special Provisions. No Claim under this provision will be allowed the Contractor for overhead or prospective profits on Work not completed by the Contractor.

6-5.2 Termination for Convenience

6-5.2.1 Grounds. The Agency may, at any time, terminate the Contractor's performance of the Work, in whole or in part, for the Agency's convenience without regard to the Contractor's fault or breach upon fourteen (14) Calendar Days' written notice to the Contractor.

6-5.2.2 Immediate Contractor Action. Upon receipt of written notice from the Agency of such termination for the Agency's convenience, the Contractor shall, unless the notice directs otherwise, do the following:

- A. Cease performance of the Work to the extent specified in the notice;
- B. Cooperate with the Agency to secure the site and demobilize in a safe and orderly fashion;
- C. Take actions necessary, or that the Agency may direct, for the protection and preservation of the Work;
- D. Except for Work directed to be performed in the notice, incur no further costs and enter into no further subcontracts and purchase orders;
- E. If requested by the Agency, assign to the Agency, in the manner and to the extent directed, all of the right, title and interest to the Contractor under the subcontracts, and the Agency shall have no liability for acts, omissions, or

- causes of action resulting therefrom which accrued prior to the date of termination and assignment, which liability shall remain with the Contractor; and
- F. Turn over to the Agency, as soon as possible, but not later than thirty (30) Calendar Days after receipt of such termination notice, the originals of all of the Contractor's records, files, documents, drawings, and any other items relating to the Project, whether located on the Project site, at the Contractor's office, or elsewhere.

6-5.2.3 Waiver of Claims. In the event that the Agency terminates the Contractor's performance of the Work for convenience, the Contractor agrees to waive any claims for damages, including, but not limited to, home office overhead, loss of anticipated profits on account thereof, and, as the sole right and remedy of the Contractor, the Agency shall pay the Contractor in accordance with Subsection 6-5.2.4 of the Special Provisions. The provisions of the Agreement, which by their nature survive Final Acceptance, shall remain in full force and effect after such termination to the extent provided in such provisions.

6-5.2.4 Compensation. Upon termination for convenience, the Contractor shall be entitled to be paid the full cost of all Work properly done by the Contractor prior to the date of termination not previously paid for, less sums already received by the Contractor on account of the portion of the Work satisfactorily performed, but in no event shall the amounts paid hereunder exceed the portion of Work completed in accordance with the Contract Documents. In no event shall the Contractor be entitled to recover any costs, overhead, or profit for Work not performed prior to the termination notice(s).

6-6 DELAYS AND EXTENSIONS OF TIME

6-6.1 General

Delete Subsection 6-6.1 in its entirety and substitute the following:

Work will not be allowed on days predicted by the South Coast Air Quality Management District (SAQMD) to be "Stage III" smog episode days. Notification will be given to the Contractor's Representative by the Engineer no later than 3:00 p.m. on the day preceding the predicted "Stage III" episode day. The Contractor will be entitled to an extension of Contract Time for such delays, but the Contractor will not be entitled to damages or additional payment due to such delays.

Work required to maintain the Project site in a safe condition (including but not limited to maintenance of traffic control), shall be allowed on **all** days.

6-6.3.1 Excusable Non-Compensable Delay. The Parties acknowledge that the following types of events are not within the responsibility or control of Agency or are reasonably contemplated by the Parties to occur during the course of performance of the Work, which may impact the schedule for performance of the Work and may entitle the Contractor to an extension of the Contract Time: (1) pulling of cables, energizing of the underground electrical system, and removal of overhead power lines and power poles by Southern California Edison, or any other contractor, on or adjacent to the Project site; and (2) "Force Majeure" events as defined herein ("Excusable Non-Compensable Delays"). "Force Majeure" means any of the following events, which materially and adversely affect the Contractor's obligations hereunder: earthquakes, acts of God, epidemic, blockade, embargoes, rebellion, war, terrorism, national emergency, riot, act of sabotage, civil commotion, industry-wide labor strike which has material adverse impact on

the Work, discovery of any archaeological, paleontological, or cultural resources, spill of hazardous substances by a third party at or near the Project site which is required to be reported to the California Environmental Protection Agency, Department of Toxic Substances Control, discovery at, near, or on the Project site of any species listed as "threatened" or "endangered" under the Federal or State Endangered Species Act, or unusually severe weather conditions.

An extension of the Contract Time shall be the Contractor's sole remedy of the Contractor for Excusable Non-Compensable Delays. In no event shall the Contractor be entitled to any compensation or recovery of any damages in connection with the Excusable Non-Compensable Delays defined above.

6-6.3.2 Excusable Compensable Delay. "Excusable Compensable Delay" means any delay to the Critical Path of the Work occurring after commencement and prior to completion of the Work: (1) which directly impacts the Contract Time established in the Agreement; (2) for which the Agency is responsible, is unreasonable under the circumstances involved and not within the contemplation of the Parties; and (3) is not due, in whole or in part, to the breach, negligence, or fault of the Contractor, or its subcontractors or suppliers. The Contractor's remedy for Excusable Compensable Delay shall be an extension of the Contract Time and reimbursement of actual costs directly resulting from such delays and markup established according to Subsection 3-3.2.3 of the Special Provisions.

6-7 TIME OF COMPLETION

6-7.2 Working Day

The term "Working Day" shall mean any Calendar Day except Saturdays, Sundays, and legal holidays observed at the locale of the Project. **City offices are open Monday through Thursday 7:30 a.m. to 5:30 p.m. and on Fridays 7:30 a.m. to 4:30 p.m.**

The following days have been designated as holidays by the City of Moreno Valley:

| | |
|-----------------------------------|------------------------------------|
| New Year's Day | January 1 |
| Martin Luther King, Jr. Day | 3rd Monday in January |
| President's Day | 3rd Monday in February |
| Memorial Day | Last Monday in May |
| Independence Day..... | July 4 |
| Labor Day..... | 1st Monday in September |
| Veterans' Day | November 11 |
| Thanksgiving | 4 th Thurs. in November |
| Day after Thanksgiving | 4th Friday in November |
| Christmas Eve | December 24 |
| Christmas Day | December 25 |

If a holiday falls upon a Sunday, the following Monday shall be the day the holiday is observed, and if a holiday falls upon a Saturday, the preceding Friday shall be the day the holiday is observed.

6-7.3 Contract Time Accounting

Add the following at the end of Subsection 6-7.3:

The Contract Time for completion of the Work, including corrective items of Work, shall be in accordance with Section 5 of the Agreement. Contract Time extensions, when granted by the Engineer, will be in Working Days, will be in accordance with the Contract Documents, and will be set forth in writing via Change Order.

6-7.4 Work Outside Regular Hours

Work shall not be allowed outside of regular working hours (weekdays, 7:00 a.m. to 3:30 p.m., unless otherwise specified) without the advance approval of the Engineer, except Work items relating to maintenance and clean-up of the Work area for the purpose of public safety and convenience. The Contractor shall request such approval from the Engineer at least 48 hours (two Working Days) in advance of the proposed Work. The Contractor shall not fuel, grease, or otherwise service equipment or trucks from 7:00 p.m. to 6:00 a.m., Monday through Friday, and at no time on Sunday or holidays. Service work on equipment will be allowed on Saturday from 8:00 a.m. to 4:00 p.m.

Should Work outside of the above hours be approved, inspection, testing and construction engineering costs as a result of the Work outside of regular working hours shall be paid by the Contractor at the hourly rate, including fringe benefits, at straight time or time and one-half rates as applicable, or if a consultant inspection service is retained by the Agency, then the Contractor will reimburse the Agency for the actual cost. Under no circumstances will Work outside regular hours be allowed without full-time inspection.

6-8 COMPLETION, ACCEPTANCE, AND WARRANTY**6-8.1 Completion**

Add the following at the end of Subsection 6-8.1:

“Completion” shall be understood to mean “Final Completion,” as defined in Subsection 1-2 of the Special Provisions.

6-8.2 Acceptance

Add the following at the end of Subsection 6-8.2:

“Acceptance” shall be understood to mean “Final Acceptance,” as defined in Subsection 1-2 of the Special Provisions.

6-8.3 Warranty

Delete Subsection 6-8.3 in its entirety and substitute the following:

The Contractor warrants to the Agency that materials and equipment furnished under the Contract will be of good quality and new unless the Contract Documents require or permit otherwise. The Contractor further warrants that the Work will conform to the requirements of the Contract Documents and will be free from defects, except for those inherent in the quality of the Work the Contract Documents require or permit. Work, materials, or equipment not conforming to these requirements, including “or equal” substitutions not properly approved and authorized, may be considered defective. The Contractor’s warranty excludes remedy for damage or defect caused by abuse, alterations to the Work not executed by the Contractor, improper or

insufficient maintenance, improper operation, or normal wear and tear and normal usage. If required by the Engineer, the Contractor shall furnish satisfactory evidence as to the kind and quality of materials and equipment. The Contractor's Performance Bond surety shall be liable for breaches of these warranties and the correction guarantees described herein.

In addition to the Contractor's obligations described above, if, within **one (1) year** after the date of Final Acceptance or designated portion thereof, or by terms of an applicable special warranty required by the Contract Documents, any of the Work is found to be not in accordance with the requirements of the Contract Documents, the Contractor shall, at its own expense, correct it promptly after receipt of written notice from the Agency to do. Such correction shall consist of making any repair or replacement necessary, including repair of settled backfill and resurfacing. In addition, the Contractor shall pay administrative costs related to inspection, testing, Contract administration, and attorneys' fees incurred to bring the Work to full compliance with the Contract Documents. If the Contractor fails to make such correction promptly, the Agency may, at its sole option, with its own or outside forces, correct the deficiencies. In such case, an appropriate Change Order or Construction Change Directive shall be issued deducting from payments then or thereafter due the Contractor the reasonable cost of correcting such deficiencies, including compensation for the additional services and expenses made necessary by the failure of the Contractor to correct the deficiencies. If payments then or thereafter due the Contractor are not sufficient to cover such amounts, the Agency shall invoice the Contractor for the difference and the Contractor shall pay the difference to the Agency, immediately.

During the one-year correction guarantee period, the Contractor shall act on all regular complaints within 48 hours and immediately for emergency repairs. The Owner will not be required to call subcontractors, suppliers, or manufacturers directly.

The one-year period for correction of Work shall be extended by corrective Work performed by the Contractor (i.e. the one-year correction period will re-start upon completion of corrective Work).

If, in the opinion of the Engineer, defective or non-conforming Work creates a dangerous condition or requires immediate correction or attention to prevent further loss to the Agency or to prevent interruption of operations of the Agency, the Agency will attempt to give the notice required by this Subsection of the Special Provisions. If the Contractor cannot be contacted or does not comply with the Engineer's request for correction within a reasonable time as determined by the Engineer, the Agency may, in accordance with this Subsection of the Special Provisions, proceed to make such correction or provide such attention, and the costs of such correction or attention shall be charged against the Contractor. Such action by the Agency will not relieve the Contractor of the guarantees provided in this Subsection of the Special Provisions or elsewhere in the Contract Documents.

This Subsection of the Special Provisions does not in any way limit the warranty on any items for which a longer warranty is specified or on any items for which a manufacturer gives a guarantee for a longer period. The Contractor shall furnish to the Agency all appropriate warranty or guarantee certificates, as required, upon completion of the Project.

Nothing contained in this Subsection of the Special Provisions shall be construed to establish a period of limitation with respect to other obligations the Contractor has under the Contract Documents. Establishment of the one-year period for correction of Work as described

in herein relates only to the specific obligation of the Contractor to correct the Work, and has no relationship to the time within which the obligation to comply with the Contract Documents may be sought to be enforced, nor to the time within which proceedings may be commenced to establish the Contractor's liability with respect to the Contractor's obligations other than specifically to correct the Work.

SECTION 7 – RESPONSIBILITIES OF THE CONTRACTOR

7-1 THE CONTRACTOR'S EQUIPMENT AND FACILITIES

7-1.1 General

Add the following at the end of the first paragraph of Subsection 7-1.1:

Such equipment and facilities shall meet all requirements of Applicable Law.

Add the following at the end of the second paragraph of Subsection 7-1.1:

The Contractor shall provide a hand washing facility. The Contractor shall comply with all Applicable Law pertaining to public health and sanitation.

7-2.2 Prevailing Wages

7-2.2.1 Determination of Prevailing Wage Rates

7-2.2.1.1 The Agency has determined that the Contractor and subcontractors of any tier must pay not less than the prevailing wage rates to all workers employed in execution of the Contract. The Director of the Department of Industrial Relations, State of California (DIR) pursuant to the California Labor Code, has determined the general prevailing rates of wages in the locality in which the Work is to be performed. The Agency has obtained from the Director of the Department of Industrial Relations (DIR) pursuant to the Labor Code determinations of the generally prevailing rates of per diem wages and the prevailing rate for holiday and overtime work in the locality in which the Work is to be performed. Copies of said rates are on file with the Parks and Community Services Department of the City of Moreno Valley and will be made available for inspection during regular business hours and are also available on the Internet at the California Department of Industrial Relations website: <http://www.dir.ca.gov/dlsr/DPreWageDetermination.htm>. Future effective general prevailing wage rates, which have been predetermined and are on file with the California Department of Industrial Relations are referenced but not printed in the general prevailing wage rates.

7-2.2.1.2 The wage rate for any classification not listed, but which may be required to execute the Work, shall be commensurate and in accord with specified rates for similar or comparable classifications for those performing similar or comparable duties. Holidays shall be as defined in the collective bargaining agreement applicable to each particular craft, classification, or type of worker employed under the Contract. Per diem wages include employer payments for health and welfare, pensions, vacation, travel time and subsistence pay, apprenticeship or other training programs authorized by California Labor Code § 3093, and similar purposes when the term "per diem wages" is used herein. Holiday and overtime work, when permitted by law, must be paid for at the rate of at least one and one-half (1½) times the above specified rate of per diem wages, unless otherwise specified. In accordance with Section 1773.2 of the California Labor Code, the Contractor must post a schedule showing all applicable prevailing wage rates at appropriate and conspicuous locations on the job site where they can easily be seen by workers.

7-2.2.1.3 The Contractor is required to utilize apprentices as required by the California Labor Code and applicable regulations. Only apprentices, as defined in California Labor Code § 3077, who are in training under apprenticeship standards and written apprenticeship

agreements under California Labor Code § 3070 *et seq.* are eligible to be employed for the Work.

7-2.2.2 Payment of Prevailing Wage Rates

7-2.2.2.1 Statutory Requirements

The Project is subject to the provisions of Labor Code § 1720 *et seq.* and the requirements of Title 8 of the California Code of Regulations § 16000 *et seq.*, which govern the payment of prevailing wage rates on public works projects. The Contractor and subcontractors of any tier shall be governed by and required to comply with these statutes and regulations in connection with the Project. Pursuant to Labor Code § 1771, the Contractor and subcontractors of any tier must pay not less than the prevailing wage rates to all workers employed in execution of the Contract. The Contractor and all subcontractors must comply with all applicable statutes and regulations, including, but not limited to, Labor Code §§ 1771, 1775, 1777.5, 1813, and 1815.

7-2.2.2.2 Weekly Payments to Employees

The Contractor and subcontractors of any tier must pay each worker on the Project, unconditionally and not less often than once each week, the full amounts that are due and payable for the period covered by the particular payday in accordance with the prevailing wage scale determination, regardless of any contractual relationship which may be alleged to exist between the Contractor, all subcontractor, and such laborers. Thus, an employer must establish a fixed workweek and an established payday. On each payday, each worker must receive all sums due at the end of the preceding workweek and must be provided with an itemized wage statement.

7-2.2.2.3 Classifications

The Agency shall require that any class of laborers or mechanics, including apprentices and trainees, which are not listed in the General Wage Determinations and which are to be employed under this Contract, shall be classified conformably to such wage determinations. In the event the Agency does not concur in the Contractor's proposed classification or reclassification of a particular class of laborers and mechanics (including apprentices and trainees) to be used, the question, accompanied by the recommendation of the Agency, shall be referred to the State Director of Industrial Relations for determination.

7-2.2.2.4 Fringe Benefit Cash Equivalent

The Agency shall require, whenever the minimum wage rate prescribed for a class of laborers or mechanics includes a fringe benefit which is not expressed as an hourly wage and the Contractor is obligated to pay a cash equivalent of such a fringe benefit, an hourly cash equivalent thereof must be established. In the event the interested parties cannot agree upon cash equivalent of the fringe benefit, the questions, accompanied by the recommendation of the Agency, shall be referred to the State Director of Industrial Relations for determination.

Attachment: Special Provisions PCS HSG GR-JFK RENO (2845 : APPROVE AND EXECUTE AGREEMENT FOR THE INSTALLATION OF A

7-2.2.3 Penalty for Prevailing Wage Rate Underpayment

Pursuant to Labor Code § 1775, the Contractor must, as a penalty, forfeit not more than Two Hundred Dollars (\$200.00) to the State or the Owner for each Calendar Day or portion thereof, for each worker paid less than the prevailing wage rates as determined by the Director of the Department of Industrial Relations for such work or craft in which such worker is employed for the Work by the Contractor or by subcontractors of any tier, in connection with the Work. The difference between prevailing wage rates and the amount paid to each worker each Calendar Day, or portion thereof, for which each worker paid less than the prevailing wage rate, must be paid to each worker by the Contractor.

7-2.2.4 Withholding

The Agency shall upon its own action or upon written request of an authorized representative of the Department of Labor or DIR, withhold or cause to be withheld from the Contractor under this Contract so much of the accrued payments or advances as may be considered necessary to pay laborers and mechanics, including apprentices, trainees, and helpers, employed by the Contractor or any subcontractor the full amount of wages required by the Contract. In the event of failure to pay any laborer or mechanic, including any apprentice, trainee, or helper, employed or working on the site of the Work, all or part of the wages required by the Contract, the Agency may, after written notice to the Contractor, take such action as may be necessary to cause the suspension of any further payment, advance, or guarantee of funds until such violations have ceased.

7-2.2.5 Responsibility for Subcontractors' Payment of Prevailing Wages

Pursuant to Labor Code § 1774, the Contractor is responsible for ensuring that subcontractors of any tier comply with requirements for payment of prevailing wages. The Contractor is responsible for Labor Code violations by subcontractors of any tier. The agreement executed between the Contractor and each subcontractor must contain a copy of the provisions of Labor Code §§ 1771, 1775, 1777.5, 1813, and 1815, at a minimum. The Contractor must monitor each subcontractor's payment of prevailing wage rates. Upon becoming aware of the failure of any subcontractor of any tier to pay its workers the specified prevailing wage, the Contractor must diligently take action to halt and rectify the failure, including, without limitation, retaining sufficient funds due to the subcontractor to cover the underpayment. Before making final payment to any subcontractor, the Contractor must obtain an affidavit from the subcontractor, signed under penalty of perjury, which states that the subcontractor has paid the specified, determined prevailing wage rate to its employees for the Project, as well as any amounts due pursuant to Labor Code § 1813. The Contractor must provide copies of such affidavits to the Owner and provide the Contractor's affidavit that it has paid the specified, determined prevailing wage rate to its employees for the Project, as well as any amounts due under Labor Code § 1813.

7-2.3 Payroll Records

7-2.3.1 Certified Payroll Records and Basic Payroll Records

The Contractor and Subcontractors of any tier must maintain Certified Payroll Records and "Basic Payroll Records," defined as time cards, front and back copies of canceled checks, cash receipts, trust fund forms, daily logs, employee sign-in sheets, accounting ledgers, tax

forms and/or any other record maintained for the purposes of reporting payroll, during the course of the Work and must preserve them for a period of **three (3) years** after completion of the Project for all tradeworkers executing the Work of the Contract. Certified Payroll Records must be submitted at the times designated in **Subsection 7-2.3.2** below or upon request as described in **Subsection 7-2.3.3** below. The Agency reserves the right to require the Contractor to routinely submit Basic Payroll Records may be requested by the Agency at any time and must be provided within **ten (10) Calendar Days** following the receipt of the request.

7-2.3.2 Submittal of Certified Payroll Records

Pursuant to Labor Code § 1776, the Contractor and each subcontractor of any tier must maintain an accurate, weekly payroll record showing the employee full name, address, social security number, work classification, amount paid per hour, straight time, overtime and holiday hours worked each day and weekly totals, the actual per diem wages paid to each person employed for the Work, and the gross/net wages paid for this Project/all projects, as well as the Contractor name and address, Project name and location, and dates of payroll. If payments are made to any third party trust, funds or plans for health and welfare, pension or vacation trusts, those payments must be stated on the Certified Payroll Record. The basic wage rate paid per hour plus the employer contributions for benefits, including training fund contributions, must at least equal the prevailing wage rate for that classification.

The Contractor must maintain and submit one (1) copy of its Certified Payroll Records and those of its subcontractors weekly with the Contractor’s application for payment. The Agency requires the Contractor to submit to the Agency each week, no later than seven (7) Calendar Days after the payday for the week covered, the Certified Payroll Records of the Contractor and its subcontractors of every tier. If there is no Work on a given week or on a given day, the Certified Payroll Record must indicate “no work” for that week or day(s). The Certified Payroll Records must account for each day of the week including Saturdays, Sundays and holidays. The Contractor and subcontractors of every tier must write “final” on the last submitted Certified Payroll Record for the Project.

The Certified Payroll Records must be verified by a written declaration made by a person with authority to represent the reporting entity, under penalty of perjury, that the information contained in the payroll record is true and correct and that the reporting entity has complied with the requirements of California Labor Code §§ 1771, 1811, and 1815 for any Work performed by his, her or its employees on the Project.

In addition, the Agency reserves the right to require the Contractor to provide monthly certified payroll records of local hiring and non-local hiring to ascertain local participation and shall allow the Agency and Agency’s staff to conduct onsite visits upon request to ascertain local hiring participation.

The Contractor agrees that submission of Certified Payroll Records as well as all related or subsequent requests for supporting document made by the Agency shall be a condition precedent to the Contractor’s receipt of a progress, final, or retention payment. The Agency shall withhold any portion of the progress, final, or retention payment up to and including the entire payment until the Certified Payroll Records requirement is met by the Contractor or its subcontractors. If the Contractor or any subcontractor is determined to have failed to pay workers in compliance with the applicable prevailing wage sections of the Labor Code, the

Agency shall continue to withhold progress, final, or retention payments until sufficient funds have been withheld for payment of wages to workers and all applicable penalties.

7-2.3.3 Making Certified Payroll Records Available Upon Request

Pursuant to Labor Code § 1776, in addition to its obligation to deliver certified payroll records to the Owner on a weekly basis as set forth above, the Contractor must also make payroll records available for inspection at all reasonable hours at the principal office of the Contractor on the following basis: (i) a certified copy of an employee's payroll record must be made available for inspection or furnished to such employee or his/her authorized representative on request; (ii) a certified copy of all payroll records must be made available for inspection or furnished upon request to the Owner, the Division of Labor Standards Enforcement and the Division of Apprenticeship Standards of the Department of Industrial Relations; (iii) a certified copy of payroll records must be made available upon request to the public for inspection or copies thereof made; provided, however, that a request by the public must be made through either the Agency, the Division of Apprenticeship Standards, or the Division of Labor Standards Enforcement. If the requested payroll records have not been previously provided to the Agency, the Division of Apprenticeship Standards or the Division of Labor Standards Enforcement, the requesting party must, prior to being provided the records, reimburse the cost of preparation by the Contractor, subcontractors and the entity through which the request was made; and the public may not be given access to such records at the principal office of the Contractor; (iv) the Contractor must file a certified copy of the payroll records with the entity that requested such records within **ten (10) Calendar Days** after receipt of a written request; and (v) any copy of records made available for inspection as copies and furnished upon request to the public or any public agency by the Agency, the Division of Apprenticeship Standards or the Division of Labor Standards Enforcement shall be marked or obliterated in such a manner as to prevent disclosure of an individual's name, address and social security number. The name and address of the Contractor or any subcontractor of any tier, performing a part of the Work must not be marked or obliterated. The Contractor must inform the Owner of the location of payroll records, including the street address, city and county and must, within **five (5) Working Days**, provide a notice of a change or location and address.

7-2.3.4 Forfeiture for Failure to Comply with Written Record Request Laws

The Contractor or all subcontractors shall have **ten (10) Calendar Days** in which to comply, subsequent to receipt of written request regarding Certified Payroll Records or Basic Payroll Records. In the event the Contractor or a subcontractor fails to strictly comply after such 10-day period, the Contractor or subcontractor shall, as a penalty to the State or the Owner, forfeit One Hundred Dollars (\$100.00) for each Calendar Day, or portion thereof, for each worker, until strict compliance is effectuated. Upon the request of the Division of Apprenticeship Standards or the Division of Labor Standards Enforcement, these penalties shall be withheld from any portion of the Contract Price then or thereafter due the Contractor. The Contractor is not subject to a penalty assessment pursuant to this paragraph due to the failure of a subcontractor to comply with this Subsection of the Special Provisions.

7-2.3.5 Statement of Employer Payments

Within **five (5) Calendar Days** of the Agency's request, the Statement of Employer Payments (**DSLE Form PW 26**) must be completed and submitted to the Agency by the Contractor and any subcontractor who pays benefits to a third party trust, plan or fund for health

and welfare benefits, vacation funds or makes pension contributions. The form must contain, for each worker classification, the fund or trust name, address, administrator, and amount per hour contributed and frequency of contributions. Training fund contributions must also be reported on this form. In February and August of each year during the Project, the Contractor and Subcontractors of any tier must verify changes in wage rates for any trade classifications used on the Project.

7-2.4 Hours of Labor

7-2.4.1 Limits on Hours of Labor

Pursuant to Labor Code § 1810, eight (8) hours of labor shall constitute a legal day's work. Pursuant to Labor Code § 1811, the time of service of any worker employed at any time by the Contractor or by a Subcontractor, of any tier, upon the Work or upon any part of the Work, is limited and restricted to eight (8) hours during any one Calendar Day and forty (40) hours during any one calendar week, except as hereafter provided. Notwithstanding the foregoing provisions, Work performed by employees of the Contractor or any Subcontractor, of any tier, in excess of eight (8) hours per day and forty (40) hours during any one week, shall be permitted upon compensation for all hours worked in excess of eight (8) hours per day at not less than one and one-half (1½) times the basic rate of pay.

7-2.4.2 Penalty for Excess Hours

Pursuant to Labor Code §§ 1813 and 1815, the Contractor shall pay to the State or the Owner a penalty of Twenty-five Dollars (\$25.00) for each worker employed in the execution of the Contract by the Contractor or any Subcontractor, of any tier, for each Calendar Day during which such worker is required or permitted to work more than eight (8) hours in any Calendar Day and forty (40) hours in any one calendar week, in violation of the provisions of the California Labor Code, unless compensation to the worker so employed by the Contractor is not less than one and one-half (1½) times the basic rate of pay for all hours worked in excess of eight (8) hours per day.

7-2.4.3 Contractor Responsibility for Cost of Excess Hours

Any Work performed by workers necessary to be performed after regular working hours or on Sundays or other holidays must be performed without adjustment to the Contract Price or any other additional expense to the Agency.

7-2.5 Apprentices

7-2.5.1 Apprenticeship Committee Contract Award Information

Pursuant to Labor Code § 1777.5 and Title 8 California Code of Regulations § 230, the Contractor and Subcontractors of any tier who are not already approved to train by an apprenticeship program sponsor must, within ten (10) Calendar Days of signing the Contract or Subcontract, as applicable, but in any event prior to the first day in which the Contractor has workers employed on the Project, must submit contract award information. This information may be submitted on a Public Works Contract Award Information form (DAS form 140). The contract award information must be provided to the appropriate local apprenticeship committees

whose geographic area of operation include the area of the Project and can supply apprentices to the Project.

7-2.5.2 Employment of Apprentices

Labor Code § 1777.5 and Title 8 California Code of Regulations § 200 *et seq.* provide detailed requirements for employing apprentices on public works. The responsibility of complying with Section 1777.5 and the regulations lies exclusively with the Contractor. When the Contractor or Subcontractor employs workers in any Apprenticeable Craft or Trade, the Contractor and Subcontractor must employ apprentices in at least the ratio set forth in Labor Code Section 1777.5.

Every apprentice employed to perform any of the Work must be paid the prevailing rate of per diem wages for apprentices in the trade to which such apprentice is registered, and such individual must be employed only for the work of the craft or trade to which such individual is registered.

Only apprentices, as defined in Labor Code § 3077, who are in training under apprenticeship standards and written apprenticeship agreements under California Labor Code § 3070 *et seq.* are eligible to be employed for the Work. The employment and training of each apprentice shall be in accordance with either of the following:

- a. The apprenticeship standards and apprentice agreements under which such apprentice is training; or
- b. The rules and regulations of the California Apprenticeship Council, including regulations Section 230.1(c), which requires that apprentices employed on public projects can only be assigned to perform work of the craft or trade to which the apprentice is registered and that the apprentices must at all times work with or under the direct supervision of journeyman/men.

7-2.5.3 Apprenticeship Certificate and Request for Dispatch of Apprentices

- a. When the Contractor or any Subcontractor of any tier in performing any of the Work employs workers in any Apprenticeable Craft or Trade, as defined in **Subsection 7-2.5.4** below, the Contractor and such Subcontractor may apply to the Joint Apprenticeship Committee administering the apprenticeship standards of the craft or trade in the area of the site of the Work for a certificate approving the Contractor or such Subcontractor under the apprenticeship standards for the employment and training of apprentices in the area or industry affected, provided, however, that the approval as established by the Joint Apprenticeship Committee or Committees shall be subject to the approval of the Administrator of Apprenticeship. The Joint Apprenticeship Committee or Committees, subsequent to approving the Contractor or Subcontractor, shall arrange for the dispatch of apprentices to the Contractor or such Subcontractor in order to comply with California Labor Code § 1777.5. There shall be an affirmative duty upon the Joint Apprenticeship Committee or Committees, administering the

apprenticeship standards of the crafts or trades in the area of the site of the Work, to ensure equal employment and affirmative action and apprenticeship for women and minorities. Contractors or Subcontractors shall not be required to submit individual applications for approval to local Joint Apprenticeship Committees provided they are already covered by the local apprenticeship standards.

- b. Contractors who are not already approved to train apprentices must request dispatch of required apprentices from one of the applicable Apprentices Committees whose geographic area of operation includes the site of the Project by giving the committee actual notice of at least forty-eight (48) hours (excluding Saturdays, Sundays and holidays) before the date on which one or more apprentices are required. Contractors and Subcontractors may use **DAS form 142** to make the request for apprentices. However, if a non-signatory contractor declines to abide by and comply with the terms of a local committee's standards, the Apprenticeship Committee shall not be required to dispatch apprentices to such contractor. Conversely, if in response to a written request, an Apprenticeship Committee does not dispatch any apprentice to a contractor who has agreed to employ and train apprentices in accordance with either the Apprenticeship Committee's Standards or the California Apprenticeship Counsel Regulations (Title 8, Section 230 *et seq.*) within 72 hours of such request (excluding Saturdays, Sundays and holidays) the Contractor shall not be considered in violation of Section 230.1 as a result of failure to employ apprentices for the remainder of the Project, provided the Contractor has made the request in enough time to meet the required ratio. If an Apprenticeship Committee dispatches fewer apprentices than the Contractor or Subcontractor requested, the Contractor or Subcontractor shall be considered in compliance if the Contractor employs those apprentices who are dispatched, provided that, where there is more than one Apprenticeship Committee able and willing to unconditionally dispatch apprentices, a contractor or Subcontractor who is not a participant in an apprenticeship program has requested dispatch from at least two committees.

7-2.5.4 Ratio of Apprentices to Journeymen

- a. The ratio of Work performed by apprentices to journeymen, who shall be employed in the Work, may be the ratio stipulated in the apprenticeship standards under which the Joint Apprenticeship Committee operates, but in no case shall the ratio be less than one hour of apprentice work for every five hours of labor performed by a journeyman, except as otherwise provided in California Labor Code § 1777.5. The ratio of apprentice work to journeyman work shall apply during any day or portion of a day when any journeyman is employed at the site of the Work and shall be computed on the basis of the hours worked during the day by journeymen so employed. Any Work performed by a journeyman in excess of eight hours per day or 40 hours per week shall not be used to calculate the ratio. The Contractor must employ apprentices for the number of hours computed as above before the end of the Contract or subcontract, as

applicable. The Contractor must, however, endeavor, to the greatest extent possible, to employ apprentices during the same time period that the journeymen in the same craft or trade are employed at the site of the Work. Where an hourly apprenticeship ratio is not feasible for a particular craft or trade, the Division of Apprenticeship Standards, upon application of a Joint Apprenticeship Committee, may order a minimum ratio of not less than one apprentice for each five journeymen in a craft or trade classification.

- b. The Contractor or any Subcontractor covered by this Paragraph and California Labor Code § 1777.5, that has agreed to be covered by an Apprenticeship Program's standards, upon the issuance of the approval certificate, or that has been previously approved in such craft or trade, must employ the number of apprentices or the ratio of apprentices to journeymen stipulated in the apprenticeship standards, but in no event less than the 1-to-5 hourly ratio. Upon proper showing by the Contractor that it employs apprentices in such craft or trade in the State of California on all of its contracts on an annual average of not less than one apprentice to each five journeymen, the Division of Apprenticeship Standards may grant a certificate exempting the Contractor from the 1-to-5 hourly ratio as set forth in this Paragraph and California Labor Code § 1777.5.

7-2.5.5 Exemption

The requirement to employ apprentices shall not apply to contracts of general contractors, or to contracts of specialty contractors not bidding for work through a general or prime contractor, involving less than Thirty Thousand Dollars (\$30,000.00) or **twenty (20) Working Days**. The term "Apprenticeable Craft or Trade," as used herein shall mean a craft or trade determined as an Apprenticeable occupation in accordance with rules and regulations prescribed by the Apprenticeship Council.

7-2.5.6 Contributions to Trust Funds

The Contractor or any Subcontractor of any tier who performs any of the Work by employment of journeymen or apprentices in any Apprenticeable Craft or Trade shall contribute to the California Apprenticeship Council in the same amount that the Director determines is the prevailing amount of apprenticeship training contributions in the area of the Project. The Contractor or any Subcontractor, of any tier, may take as a credit for payments to the Council any amounts paid by the Contractor or Subcontractor to an approved apprenticeship program that can supply apprentices to the Project. Contractors who do not contribute to an apprenticeship program must submit their contributions to the California Apprenticeship Council. Training Fund contributions are due and payable on the 15th day of the month for work performed during the preceding month. Training contributions to the California Apprenticeship Council shall be paid by check and shall be accompanied by a **Completed Training Fund Contribution form (CAC-2)**. Contractors who contribute to an apprenticeship program are entitled to a full credit in the amount of those contributions. The Division of Labor Standards Enforcement is authorized to enforce the payment of such contributions to such fund(s) as set forth in California Labor Code §227. Such contributions shall not result in an increase in the Contract Price.

7-2.5.7 Contractor's Compliance

The responsibility of compliance with this Subsection of the Special Provisions for all Apprenticeship Trades or Crafts is solely and exclusively that of the Contractor. All decisions of the Joint Apprenticeship Committee(s) under this Subsection of the Special Provisions are subject to the provisions of California Labor Code § 3081. In the event the Contractor willfully fails to comply with the provisions of this Paragraph and California Labor Code § 1777.5, pursuant to California Labor Code § 1777.7, the Contractor shall: (i) be denied the right to bid on any public works contract for a period of one (1) year from the date the determination of noncompliance is made by the Administrator of Apprenticeship; and (ii) forfeit, as a civil penalty, One Hundred Dollars (\$100.00) for each Calendar Day of noncompliance. Notwithstanding the provisions of California Labor Code § 1727, upon receipt of such determination, the Agency shall withhold such amount from the Contract Price then due or to become due. Any such determination shall be issued after a full investigation, a fair and impartial hearing, and reasonable notice thereof in accordance with reasonable rules and procedures prescribed by the California Apprenticeship Council. Any funds withheld by the Agency pursuant to this Paragraph shall be deposited in the fund that funded the Project unless otherwise specified by the Engineer. The interpretation and enforcement of California Labor Code §§ 1777.5 and 1777.7 shall be in accordance with the rules and procedures of the California Apprenticeship Council.

7-2.6 Employment of Minors

The Contractor shall not employ or engage any minor less than 16 years of age for the purpose of building or construction work of any kind (Title 8 CAC 11701, LC 1294). When minors between 16 and 18 years of age are employed or engaged in building or construction work, the Contractor must obtain permits to work and permits to employ minors from school authorities in the school district in which the minor resides or attends school (ED 49110 to 49113, 49131, & 49160). Any contractor that hires a minor of 16 years of age or older who is a high school graduate or who has been awarded a certificate of proficiency is exempt from the permit requirements (ED 49101).

The Contractor shall keep on file all permits to work and permits to employ, records showing the names, ages (dates of birth) and address of all minors employed, along with payroll records for at least three years (ED 49161, LC 1174, 1175, 1299). The minors' records are to be open at all times for inspection by school attendance officers, members of the Industrial Welfare Commission, and designees, probation officers, officers of the Superintendent at Public Instruction, and officers of the Division of Labor Standards Enforcement (ED 49164, 49181, LC 1174, 1299). The Contractor shall submit to the Agency a copy of Permits to Work and Permits to Employ or proof of graduation or certificate of proficiency before any minor is allowed to work.

Failure to comply with the provisions of the child labor laws may cause the imposition of criminal and civil sanctions.

7-2.7 Labor Nondiscrimination

Pursuant to Labor Code Section 1735, no discrimination shall be made in the employment of persons upon public works because of the race, religious creed, color, national origin, ancestry, physical disability, mental disability, medical condition, marital status, or sex of

such persons, except as provided in Section 12940 of the Government Code, and every contractor for public works violating Labor Code Section 1735 is subject to all the penalties imposed for a violation of Division 2, Part 7, Chapter 1 of the Labor Code.

7-2.7.1 During the performance of this Contract, the Contractor and its Subcontractors shall not unlawfully discriminate against any employee or applicant for employment because of race, religion, color, national origin, ancestry, physical disability, mental disability, medical condition, marital status, age (over 40) or sex. Contractors and Subcontractors shall ensure that the evaluation and treatment of their employees and applicants for employment are free of such discrimination. Contractors and Subcontractors shall comply with the provisions of the California Fair Employment and Housing Act (CGC 12900 et seq.) and the applicable regulations promulgated thereunder (California Code of Regulations, Title 2, Section 7285.0 et seq.). The applicable regulations of the Fair Employment and Housing Commission implementing Government Code Section 12990, set forth in Title 2, Division 4, Chapter 5 of the California Code of Regulations are incorporated into this Contract by reference and made a part hereof as if set forth in full. The Contractor and its Subcontractors shall give written notice of their obligations under this clause to labor organizations with which they have a collective bargaining or other agreement.

7-2.7.2 The Contractor shall include the nondiscrimination and compliance provisions of Subsection 7-2.5 of the Special Provisions in all subcontracts to perform Work under the Contract.

7-2.7.3 These provisions are applicable to all Contractors and Subcontractors having a construction Contract or subcontract of \$5,000 or more:

1. As used herein:
 - a. "Administrator" means Administrator, Office of Compliance Programs, California Department of Fair Employment and Housing, or any person to whom the Administrator delegates authority;
 - b. "Minority" includes:
 - i. Black (all persons having primary origins in any of the black racial groups of Africa, but not of Hispanic origin);
 - ii. Hispanic (all persons of primary culture or origin in Mexico, Puerto Rico, Cuba, Central or South America or other Spanish derived culture or origin regardless of race);
 - iii. Asian/Pacific Islander (all persons having primary origins in any of the original peoples of the Far East, Southeast Asia, the Indian Subcontinent or the Pacific Islands); and
 - iv. American Indian/Alaskan Native (all persons having primary origins in any of the original peoples of North America and who maintain culture identification through tribal affiliation or community recognition).
2. Whenever the Contractor or any Subcontractor subcontracts a portion of the Work, it shall physically include in each subcontract of \$5,000 or more, the nondiscrimination clause in this Contract directly or through incorporation by reference.

3. The Contractor shall implement the specific nondiscrimination standards provided in paragraph 6(a) through (e) of this Subsection of the Special Provisions.
4. Neither the provisions of any collective bargaining agreement, nor the failure by a union with whom the Contractor has a collective bargaining agreement, to refer either minorities or women, shall excuse the Contractor's obligations under this Subsection of the Special Provisions, Government Code Section 12990, or the regulations promulgated pursuant thereto.
5. In order for the nonworking training hours of apprentices and trainees to be counted, such apprentices and trainees must be employed by the Contractor during the training period, and the Contractor must have made a commitment to employ the apprentices and trainees at the completion of their training, subject to the availability of employment opportunities. Trainees must be trained pursuant to training programs approved by the U.S. Department of Labor or the California Department of Industrial Relations.
6. The Contractor shall take specific actions to implement its nondiscrimination program. The evaluation of the Contractor's compliance with this Subsection of the Special Provisions shall be based upon its effort to achieve maximum results from its actions. The Contractor must be able to demonstrate fully its efforts under steps (a) through (e) below.
 - a. Ensure and maintain a working environment free of harassment, intimidation, and coercion at all sites, and at all facilities at which the Contractor's employees are assigned to work. The Contractor shall specifically ensure that all foremen, superintendents, and other on-site supervisory personnel are aware of and carry out the Contractor's obligations to maintain such a working environment, with specific attention to minority or female individuals working at such sites or in such facilities.
 - b. Provide written notification within seven days to the director of DFEH when the union or unions with which the Contractor has a collective bargaining agreement has not referred to the Contractor a minority person or woman sent by the Contractor, or when the Contractor has other information that the union referral process has impeded the Contractor's efforts to meet its obligations.
 - c. Disseminate the Contractor's equal employment opportunity policy by providing notice of the policy to unions and training, recruitment, and outreach programs and requesting their cooperation in assisting the Contractor to meet its obligations; and by posting the company policy on bulletin boards accessible to all employees at each location where construction work is performed.
 - d. Ensure all personnel making management and employment decisions regarding hiring, assignment, layoff, termination, conditions of work,

training, rates of pay or other employment decisions, including all supervisory personnel, superintendents, general foremen, on-site foremen, etc., are aware of the Contractor's Equal Employment Opportunity Policy and obligations, and discharge their responsibilities accordingly.

- e. Ensure that seniority practices, job classifications, work assignments and other personnel practices, do not have a discriminatory effect by continually monitoring all personnel and employment related activities, to ensure that the equal employment related activities, the employment opportunity policy, and the Contractor's obligations under these Specifications are being carried out.
7. Contractors are encouraged to participate in voluntary associations that assist in fulfilling their equal employment opportunity obligations. The efforts of a Contractor association, joint contractor-union, contractor-community, or other similar group of which the Contractor is a member and participant, may be asserted as fulfilling any one or more of its obligations under this Subsection of the Special Provisions provided that the Contractor actively participates in the group, makes every effort to assure that the group has a positive impact on the employment of minorities and women in the industry, ensures that the concrete benefits of the program are reflected in the Contractor's minority and female workforce participation, and can provide access to documentation which demonstrates the effectiveness of actions taken on behalf of the Contractor. The obligation to comply, however, is the Contractor's.
 8. The Contractor is required to provide equal employment opportunities for all minority groups, both male and female, and all women, both minority and non-minority. Consequently, the Contractor may be in violation of the Fair Employment and Housing Act (CGC Section 12900 et seq.) if a particular group is employed in a substantially disparate manner.
 9. Establishment and implementation of a bona fide Affirmative Action Plan pursuant to Title 2 California Code of Regulations Section 8104(b) shall create a rebuttal presumption that a contractor is in compliance with the requirements of Government Code Section 12990 and its implementing regulations.
 10. The Contractor shall not use the nondiscrimination standards to discriminate against any person because of race, color, religion, sex, national origin, ancestry, physical disability, mental disability, medical condition, marital status, or age over 40.
 11. The Contractor shall not enter into any subcontract with any person or firm decertified from state Contracts pursuant to Government Code Section 12990.
 12. The Contractor shall carry out such sanctions and penalties for violation of this Subsection of the Special Provisions and the nondiscrimination clause, including suspension, termination and cancellation of existing subcontracts as may be imposed or ordered pursuant to Government Code Section 12990, and its implementing regulations by the awarding agency. Any contractor who fails to

carry out such sanctions and penalties shall be in violation of this Subsection of the Special Provisions and Government Code Section 12900.

13. The Contractor shall designate a responsible official to monitor all employment related activity to ensure that the company's equal employment opportunity policy is being carried out, to submit reports relating to the Provisions hereof as may be required by OCP and to keep records. Records shall at least include for each employee the name, address, telephone numbers, construction trade, union affiliation, if any, employee identification number when assigned, social security number, race, sex, status, (e.g., mechanic, apprentice trainee, helper, or laborer), dates of changes in status, hours worked per week in the indicated trade, rate of pay, and locations at which the work was performed. Records shall be maintained in any easily understandable and retrievable form; however, to the degree that existing records satisfy this requirement, the Contractor shall not be required to maintain separate records.

7-2.8 Posting of Signs

The Contractor shall display the Project Identification Sign, the federal (if applicable) and state wage rate information, the "Equal Employment Opportunity is the Law" poster, and other required posters in a visible location at the Project site. The signs and posters shall be mounted in an acceptable manner and constructed as specified.

7-3 INSURANCE

Delete Subsection 7-3 in its entirety.

7-3.2 General Liability Insurance

See Paragraph 7 of the Agreement for insurance requirements.

7-3.34 Workers' Compensation Insurance

See Paragraph 7 of the Agreement for insurance requirements.

7-5 PERMITS

Delete Subsection 7-5 in its entirety and substitute the following:

Work shall not be started until the Contractor has obtained all necessary licenses and permits. The Contractor shall obtain and pay for all permits and give all notices necessary and incident to the due and lawful prosecution of the Work and to the preservation of the public health and safety. Unless otherwise indicated within these Special Provisions, fees will not be collected on those permits issued by the Agency for Agency-owned projects; some exceptions include Temporary Use Permit, City Business Licenses, etc. It is the responsibility of the Contractor to verify required permits and responsibility of payment therefor prior to Bid submittal.

7.5.1 Trench and Excavation Permits

Excavation shall not be started on any trench, vertical or sloping, that is five feet (5') or more in depth until the Contractor has obtained a permit from the State Division of Industrial Safety and submitted a copy of said permit to the Engineer (LC 6500). Upon demand by the

Agency or the State Division of Industrial Safety or representatives thereof, the Contractor shall produce the permit.

7-5.2 National Pollutant

The Contractor shall provide National Pollutant Discharge Elimination System (NPDES) permit training for Urban Runoff management to the Contractor’s employees and Subcontractors, if any. Each day that the Contractor fails to provide Urban Runoff management training is a violation of the current version of the Regional Water Quality Control Board Order, and a breach of the Contract with the Agency. The Contractor understands and agrees that NPDES permit violations are grounds for enforcement action by the Environmental Protection Agency, the State/Regional Water Resources Control Board, and the Agency, and may result in permit termination (stop work order), civil and criminal fines, and termination of the Contract. By submitting a Bid, the Contractor certifies to the Agency that it has trained its employees and Subcontractors, if any, for Urban Runoff management and included sufficient sums in the Bid Price to cover such costs of said training.

The Contractor is responsible for all clean up and payment of all fines levied as a result of any illegal discharge (as defined in the NPDES Permit) occurring as a result of the Contractor’s Work and/or operations.

7-5.3 Right of Entry

The Agency shall provide any required rights of entry at no cost to the Contractor for Work on private property that is shown on the Plans. Such rights of entry do not relieve the Contractor of the need to provide, at its own cost, permits and insurance required of the Contractor by other agencies and organizations.

7-5.4 Licenses

The Contractor and Subcontractors shall obtain and incur all costs for licenses necessitated by their operations. The Contractor and all Subcontractors shall obtain and keep current a City of Moreno Valley Business License prior to commencement and throughout the duration of their Work.

7-6 THE CONTRACTOR’S REPRESENTATIVE

Add the following at the end of Subsection 7-6:

On a daily basis, the Contractor’s Representative (or designated alternate) shall provide the Engineer a list of all labor, equipment, and materials used, and a summary of Work performed on the Project that day. The Contractor shall provide this information by the end of the Working Day to the Agency Inspector. If this information is not provided, the Agency will not process the Contractor’s monthly progress payment.

The Contractor’s Representative (or designated alternate) shall be present at the Project site at all times that Work is in progress. Work by Subcontractors will not be allowed in the absence of the Contractor’s Representative (or designated alternate), unless previous arrangements are approved by the Engineer in writing. In the event a Subcontractor attempts to perform Work in the absence of the Contractor’s Representative (or designated alternate), a STOP WORK NOTICE will be issued to the Subcontractor.

Attachment: Special Provisions PCS HSG GR-JFK RENO (2845 : APPROVE AND EXECUTE AGREEMENT FOR THE INSTALLATION OF A

When Work is not in progress and during periods when Work is suspended, arrangements acceptable to the Engineer shall be made for any emergency Work that may be required.

7-8 WORK SITE MAINTENANCE

7-8.1 General

Delete the second paragraph of Subsection 7-8.1 and substitute the following:

Materials spilled along or on streets, roads, any public right of way, parking areas, or private property shall be removed completely and promptly.

When and as often as required by the Engineer, the Contractor shall furnish and operate self-loading motorized street sweeper equipped with a functional water spray system, to keep paved areas affected by the work clean and dust free. If the sweeper fails to keep the paved areas clean and dust free then the Contractor shall provide additional sweepers or stop the Work until the paved areas are clean and dust free. The use of water resulting in mud on paved areas will not be permitted.

Add the following at the end of Subsection 7-8.1:

All clean-up costs shall be included in the various related items of Work and no additional compensation will be allowed as a result of suspension of Work for failure to comply with clean up orders.

Waste Management of the Inland Empire, a division of Waste Management, Inc. (Tel: 951.280.5400) has an exclusive franchise with the City of Moreno Valley for the collection, transportation, recycling, composting, and disposal of solid waste, green waste, special waste, and construction and demolition waste and for providing temporary bin/roll-off services for all commercial and residential premises within the Agency, pursuant to Moreno Valley Municipal Code Chapter 6.02, "Refuse Collection, Transfer and Disposal."

7-8.4.2 Storage in Public Streets

Delete the first paragraph of Subsection 7-8.4.2 and substitute the following:

Construction materials, stockpile and equipment shall not be stored in streets, roads, parking areas or any public right of way unless otherwise specified in the Special Provisions or approved by the Engineer. All materials or equipment not installed or used in construction shall be stored at a location approved by the Engineer. All stockpile and storage areas shall be kept in a safe, neat, clean, and orderly fashion, and shall be restored to equal or better than original condition upon completion of work.

7-8.6.4 Dewatering

Add the following at the end of Subsection 7-8.6.4:

The Contractor shall maintain drainage within and through the Work areas.

Attachment: Special Provisions PCS HSG GR-JFK RENO (2845 : APPROVE AND EXECUTE AGREEMENT FOR THE INSTALLATION OF A

7-8.7 Flood Hazards and Dry Weather Flow

Special attention is directed to possible flood hazards and nuisance water such as irrigation and other runoff. The Contractor shall be responsible for all personal injuries and for all damages to any portion of the Work occasioned by the above causes and the Contractor shall make good such injuries or damages at no cost to the Agency prior to Final Acceptance.

7-8.8 Vermin Control

At the time of Final Acceptance, structures entirely constructed under the Contract shall be free of rodents, insects, vermin, and pests. Necessary extermination work shall be arranged and paid for by the Contractor as part of the Work within the Contract Time and Contract Price, and shall be performed by a licensed exterminator in accordance with requirements of Applicable Law. The Contractor shall be liable for injury to persons or property and responsible for the elimination of offensive odors resulting from exterminating operations.

7-8.9 Protection of the Work

The Contractor shall protect all Work, materials, and equipment from damage from any cause whatsoever, and shall provide adequate and proper storage facilities during the progress of the Work. The Contractor shall provide for the safety and good condition of all Work until Final Acceptance by the Agency, and shall replace all damaged or defective Work, materials, and equipment before requesting Final Acceptance.

The Contractor is and shall be held responsible for the protection and correction of the Work of all trades from smears, splashes, stains, or damages that might occur during the progress of the Work.

The Contractor shall remove graffiti from all Work, materials, equipment, and signs within the project. Equipment, materials, or signs containing graffiti shall not be brought to the Project. Any graffiti found on Work, materials, equipment, or signs shall be cleaned or removed from the Project within 24 hours after discovery. The cost of graffiti removal shall be borne by the Contractor as part of the Contract Price.

7-8.10 Solid Waste Disposal and Recycling Report

The Contractor shall complete monthly Solid Waste Disposal and Recycling Reports and submit them to the Agency, as outlined in the Solid Waste Disposal and Recycling Report – Instructions (see Appendix). The cost of the reports shall be borne by the Contractor as part of the Contract Price.

7-9 PROTECTION AND RESTORATION OF EXISTING IMPROVEMENTS

Add the following at the end of Subsection 7-9:

Damaged traffic signal loop detectors must be replaced within seventy two (72) hours.

7-10 SAFETY

7-10.1 Street Closures, Detours, and Barricades

Rename Subsection 7-10.1 and include the following:

Street closures are usually not allowed on City streets, and may be specifically prohibited as stipulated in the Contract Documents. Otherwise, the Contractor may request full street closure consideration from the Engineer. The Contractor shall submit a request for street closure to the Engineer. The Engineer may route the request through the various City departments for approval consideration. Once there is approval from all necessary departments, the matter will be brought before the City Council for approval consideration. The estimated time frame for department and City Council consideration is approximately six (6) weeks from the time the request is received. The Contractor shall notify the Police, Fire, and Public Works Departments of, or serving, the City of Moreno Valley at least 48 hours in advance of closing, or partially closing, or of reopening, any street, alley, or other public thoroughfare, and shall comply with the requirements of said departments in respect thereto. If the telephone numbers herein below are changed, the Contractor is not relieved of the responsibility of notifying said departments.

The following telephone numbers are listed to assist the Contractors in compliance with these requirements:

| | |
|---|---------------|
| Fire Department..... | Emergency 911 |
| Business | 951.486.6784 |
| Police Department | Emergency 911 |
| Business | 951.486.6700 |
| Parks and Community Services Department | 951.413.3280 |
| Parks Projects..... | 951.413.3163 |
| Parks Maintenance | 951.413.3703 |
| Public Works Department | 951.413.3100 |
| Transportation Engineering..... | 951.413.3140 |
| Maintenance & Operations..... | 951.413.3160 |
| Capital Projects..... | 951.413.3130 |
| Land Development..... | 951.413.3120 |
| Moreno Valley Utility | 951.413.3500 |

In any site affected by peak hour traffic flows, no lane closure shall be allowed before 8:30 a.m. or after 4:00 p.m. unless approved in writing by the Engineer.

7-10.2 Traffic Controls

Rename Subsection 7-10.2 and include the following:

Traffic controls, including, but not limited to, vehicular and pedestrian traffic controls, maintenance of vehicular and pedestrian access, detours, and street closures shall be in accordance with the Special Provisions; Traffic Control Plans; California MUTCD, latest edition at the time of bid; "Work Area Traffic Control Handbook"(WATCH – latest edition at the time of bid); and Section 7-10, "Safety" and Part 6, "Temporary Traffic Control" of the latest edition of the "Greenbook," Standard Specifications for Public Works Construction, including all supplement amendments, in effect and published at the Bid Deadline. Nothing in the Special

Provisions shall be construed as relieving the Contractor from his or her responsibility to provide for the safety and convenience of traffic and the public during construction.

In the event of conflict, the order of precedence shall be as follows:

1. Special Provisions
2. Traffic Control Plans
3. California MUTCD
4. Work Area Traffic Control Handbook (WATCH)
5. Standard Specifications

Whenever vehicles or equipment are parked on the shoulder of a roadway within six feet (6') of a traffic lane, the shoulder area shall be closed with fluorescent traffic cones or portable delineators placed on a taper in advance of the parked vehicles or equipment, and along the edge of the pavement at twenty-five foot (25') intervals to a point not less than twenty-five feet (25') past the last vehicle or piece of equipment. A minimum of nine (9) cones or portable delineators shall be used for the taper. A W20-1 (Road Work) or W21-5b (Shoulder Work) sign shall be mounted on a telescoping flag tree with flags.

The Contractor shall install temporary railing (Type K-Modified) between any lane carrying public traffic and any excavation, obstacle, or storage area when the following conditions exist:

1. Excavations – Any excavation the near edge of which is twelve feet (12') or less from the edge of the lane, except:
 - a. Excavations covered with sheet steel or concrete covers of adequate thickness to prevent accidental entry by traffic or the public.
 - b. Excavations less than one foot deep.
 - c. Trenches less than one foot wide for irrigation pipe or electrical conduit or excavations less than one foot in diameter.
 - d. Excavations parallel to the lane for the purpose of pavement widening or reconstruction.
 - e. Excavations in side slopes, where the slope is less steep or equal to 4:1.
 - f. Excavations protected by existing barrier or railing.
2. Temporarily Unprotected Permanent Obstacles – Whenever the Work includes the installation of a fixed obstacle together with a protective system, such as a sign structure together with protective railing, and the Contractor elects to install the obstacle prior to installing the protective system; or whenever the Contractor, for his convenience and with permission of the Engineer, removes a portion of an existing protective railing at an obstacle and does not replace such railing complete in place during the same day.
3. Storage Areas – Whenever material or equipment is stored within twelve feet (12') of the lane and such storage is not otherwise prohibited by the Specifications.

7-10.2.1 Traffic Control Plan

The Contractor shall submit a Traffic Control Plan signed by a Traffic Engineer to the City of Moreno Valley at or prior to the pre-construction meeting for approval by the Transportation Engineering Division.

7-10.3 Haul Routes

Delete Subsection 7-10.3 and substitute the following:

Unless otherwise specified in the Special Provisions, haul routes shall conform to City-established truck routes, or as approved by the Traffic Engineer.

7-10.4 Safety

7-10.4.2 Safety Orders

Add the following at the end of Subsection 7-10.4.2:

Federal and State laws have established occupational safety and health standards with which all employers must comply. These laws require an employer to provide a safe place of employment (i.e., one that is reasonably free from danger to life or health).

The California Division of Industrial Safety (Cal/OSHA) issues citations if, during an inspection, it observes an employee exposed to an unsafe or unsanitary condition. Citations may also be issued when employee exposure can be shown to have occurred even though not observed during an inspection. Every citation will identify the violation and the gravity of the violation (serious, general, or regulatory).

In addition to the authority to issue citations, Cal/OSHA has the authority to prohibit entry into an unsafe area and the use of unsafe equipment when an imminent hazard exists (LC 6325). A violation of this type of order is a misdemeanor.

When an actual exposure cannot be demonstrated but a condition is found to exist that would be a violation if an exposure were to occur, then Cal/OSHA may issue an "Information Memorandum." To allow an employee to be exposed to a condition identified in an Information Memorandum constitutes a willful violation of the Safety Orders.

Should a contractor receive a citation, shut-down (yellow tag), or an Information Memorandum, the Contractor shall notify the Engineer of such.

7-10.4.2.2 Shoring Plan

Add the following at the end of Subsection 7-10.4.2.2

The Contractor shall comply with all applicable requirements of Labor Code Section 6705, and no requirements of that Section shall be construed to impose tort liability on the Agency or on any employee or officer of the Agency.

7-10.4.4 Hazardous Substances

Add the following at the end of Subsection 7-10.4.4

The Contractor shall take precautions not to spill or contaminate an area with hazardous material. Materials found to be hazardous substances pursuant to the Hazardous Substances Information and Training Act (Labor Code Section 6360 et seq.), such as epoxy resins, motor oils, and petroleum derivatives, shall be disposed of properly. If any hazardous material is spilled or contaminates an area, the Contractor shall notify the Riverside County Department of Health, Environmental Health Division, and have the spill or contaminated area cleaned up at the Contractor's expense. The hazardous materials shall be disposed of in accordance with the laws governing said material at a State or United States Environmental Protection Agency approved treatment, storage or disposal facility, or recycling facility. The Contractor shall give the Agency a copy of the Uniform Hazardous Waste Manifest promptly after disposition of the hazardous material. This provision shall not be construed to affect or limit any other liability, duty, or responsibility of the Contractor or other person with regard to safeguarding the health and safety of employees and other persons exposed to a toxic or hazardous material.

Any Work which involves digging trenches or other excavations that extend deeper than four feet (4') below the surface where discovery of hazardous waste or other unusual conditions may have an effect on the Work, the procedures shall be as follows:

1. The Contractor shall promptly, and before the following conditions are disturbed, notify the Agency in writing of any:
 - a. Material that the Contractor believes may be material that is hazardous waste, as defined in Section 25117 of the Health and Safety Code, which is required to be removed to a Class I, Class II, or Class III disposal site in accordance with provisions of existing law.
 - b. Subsurface or latent physical conditions at the site differing from those indicated.
 - c. Unknown physical conditions at the site of any unusual nature, different materially from those ordinarily encountered and generally recognized as inherent in work of the character provided for in the contract.
2. The Agency shall promptly investigate the conditions, and if it finds that the conditions do materially so differ, or do involve hazardous waste, and cause a decrease or increase in the Contractor's cost of, or the time required for, performance of any part of the Work shall issue a Change Order pursuant to Section 3 "Changes in Work" of the General Provisions.
3. That, in the event that a dispute arises between the public entity and the Contractor whether the conditions materially differ, or involve hazardous waste, or cause a decrease or increase in the Contractor's cost of, or time required for, performance of any part of the Work, the Contractor shall not be excused from any scheduled completion date provided by the Contract, but shall proceed with all the Work to be performed under the Contract. The Contractor shall retain any and all rights provided either by

Contract or by law which pertain to the resolution of disputes and protests between the contracting parties (PCC 7104).

7-10.4.6 Emergency Phone Numbers

The following emergency phone numbers are listed for the convenience of the Contractor to assist in complying with these requirements:

The Contractor shall keep a list of emergency phone numbers on the Project site. Whenever more than ten (10) employees are on the Project site at any time, said list shall be posted on a bulletin board, to be supplied and installed on the Project site by the Contractor, at his expense, in a location visible and accessible to all employees.

| | |
|--|------------------------|
| Ambulance Services | 911 |
| Box Springs Mutual Water Company | 951.653.6419 |
| City of Moreno Valley Fire Department | 911 or 951.486.6784 |
| City of Moreno Valley Police Department | 911 or 951.486.6700 |
| Parks and Community Services Department | 951.413.3280 |
| Parks Projects | 951.413.3163 |
| Parks Maintenance | 951.413.3703 |
| City of Moreno Valley, Public Works Department | 951.413.3100 |
| City of Moreno Valley, PW Operations & Facilities | 951.413.3160 |
| Eastern Municipal Water District (Integrated Operations Center) | 951.928.3777 ext. 6265 |
| Edgemont Community Services District (Albert A. Webb & Assoc.) | 951.686.1070 |
| Moreno Valley Community Hospital | 951.243.0811 |
| 27300 Iris Avenue, Moreno Valley (2 miles east of Perris Boulevard) | |
| Moreno Valley Unified School District | 951.485.5600 ext. 3775 |
| Moreno Valley Utilities (Electrical) | 877.811.1888 |
| Questar Southern Trails | 714.379.3376 |
| 5762 Bolsa Avenue, Suite 201 Huntington Beach, CA 92649 | |
| Riverside County Regional Medical Center | 951.486.4000 |
| 26520 Cactus Avenue (South of HWY 60) | |
| Riverside Medical Clinic | 951.683.6370 |
| 6405 Day Street (South of HWY 60, Riverside, CA) | |
| Riverside Transit Agency | 951.684.0850 |
| SBC (formerly Pacific Bell) | 800.750.2355 |
| Southern California Edison Company | 800.611.1911 |
| Southern California Gas Company (Distribution) | 909.335.3919 |
| Southern California Gas Company (Transmission) | 213.244.2268 |
| Sunesys | 951.278.0400 |
| Time Warner Communications | 951.549.3977 |
| Underground Service Alert | 800.227.2600 |
| United States Postal Service | 951.656.3240 |
| Val Verde Unified School District | 951.940.6100 |
| Valley Medical Group | 951.242.9594 |
| 24490 Sunnymead Blvd., Moreno Valley | |

| | |
|---|--------------|
| Frontier | 800.483.4000 |
| Waste Management..... | 800.423.9986 |
| Western Municipal Water District (answering service)..... | 951.789.2960 |

The Agency does not warrant the completeness or accuracy of the list or the numbers.

7-10.4.7 Safety Responsibility

The Contractor shall be solely and completely responsible for the condition of the premises on which the Work is performed and for the safety of all persons and property on the site during performance of the Work. This requirement shall not be limited to normal working hours, but shall apply continuously.

The Contractor shall provide the Engineer with the Contractor's Injury and Illness Prevention Program and a site program five (5) Working Days before the pre-construction meeting. The Injury and Illness Prevention Program shall include the name and telephone number of the Project Safety Manager or Officer.

The Contractor shall correct all unsafe conditions immediately. The Engineer shall use the following guidelines when an unsafe condition is identified:

1. Imminent Hazard – a condition that if not corrected would most likely result in an accident causing severe or permanently disabling injury or death.

When an Imminent Hazard is known to exist or when the Contractor either delays in correcting or permits repeated occurrences of an Imminent Hazard, the Engineer shall immediately order the Contractor verbally and in writing to suspend the operations affected and not permit the Work to resume until the Imminent Hazard has been corrected. The Contractor shall remove all personnel not necessary to make the corrections. The local Division of Industrial Safety office will be notified of the Imminent Hazard and of the action taken.

2. Dangerous Condition (Serious Hazard) – a condition that does not present an immediate danger to workers or the public, but if not corrected, could result in a disabling injury and possible death, or could develop into an Imminent Hazard.

When a Dangerous Condition is known to exist, the Engineer shall notify the Contractor verbally and in writing of the conditions and allow a reasonable period for correcting the Dangerous Condition. The Contractor shall remove all personnel not necessary to make the corrections. If the Engineer is not certain of the remedial measures proposed or taken by the Contractor, then the Agency or Caltrans construction safety coordinator shall be consulted. If the Contractor does not correct the Dangerous Condition or if the condition is deteriorating into an Imminent Hazard, the Engineer shall suspend the affected operations and the local Division of Industrial Safety office will be notified.

3. Minor or Non-Serious Condition – condition that could result in minor or less serious injuries, or that are repetitive in nature or that may be classified as a threat to health.

When a Minor or Non-Serious Condition is known to exist, the Engineer shall advise the Contractor verbally and in writing of the condition and of the necessity for eliminating it. If the Contractor fails to correct the problem or permits its repeated occurrence on subsequent operations, the Engineer shall suspend the affected operations.

The Contractor will not be allowed any additional compensation or extension of time for operations suspended due to unsafe conditions.

The Contractor shall immediately notify the City and document any observed defects or hazardous conditions in the vicinity of the Project site prior to, during, and after Project construction.

7-13 LAWS TO BE OBSERVED

Add the following at the end of Subsection 7-13:

If the Contractor observes that any portions of the Contract Documents are at variance with Applicable Law, the Contractor shall promptly notify the Engineer in writing by RFI. If the Contractor performs any Work when the Contractor knows or should have reasonably known it would be contrary to Applicable Law, the Contractor shall assume full responsibility therefor and shall bear all risks and costs (without adjustment to the Contract Price) directly or indirectly attributable to the correction of the Work. If the Contractor fails to comply with Applicable Law, the City may (without prejudice to any of its other rights and remedies) issue an order suspending all or any part of the Work. If the Contractor is prevented, in any manner, from strict compliance with the Contract Documents due, directly or indirectly, to Applicable Law, the Contractor shall immediately notify the Engineer.

7-15 OWNER-OPERATOR LISTING

The Contractor and Subcontractors shall list all owner-operators on the project and certify owner-operator status by providing at least the following information:

1. Operator name as shown on all payrolls.
2. Business address of the owner-operator.
3. The owner-operator’s social security number.
4. The truck/tractor license number, California identification truck number, weight, and number of axels. If equipment is used, the Contractor must provide a complete description of the equipment, make, model number, and include the dates the equipment was operated on the project.
5. Operator labor classification.
6. Hours worked by the owner-operator as reported on a daily basis.
7. Hourly rental rate paid for the owner-operator equipment.
8. Actual payments earned.

This information must be provided by the Contractor on the California Department of Transportation “Owner-Operator Listing” and “Owner-Operator Listing Statement of Compliance” forms, available online at <http://www.dot.ca.gov/hq/construc/forms/cem2505.pdf>. Certification will be accepted only from the Contractor or Subcontractor employing the owner-operator. The City will not accept certified payrolls or an Owner-Operator Listing directly from the owner-operator unless that owner-operator is a licensed contractor and is also an approved

Subcontractor or recognized lower tier sub-subcontractor. The Contractor shall submit the "Owner-Operator Listing Statement of Compliance" form weekly to the City, beginning within ten (10) Calendar Days after end of the first week worked. If there is a temporary break in the Work, then the Contractor shall submit an Owner-Operator Listing marked "no Work performed." When the owner-operator is no longer needed, then the word "final" shall be placed above the name of the owner-operator.

The information shown on the Owner-Operator Listing will be used to determine the hourly wage rate due by deducting the prevailing equipment rental rate as set forth in the California Department of Transportation publication entitled "Labor Surcharge and Equipment Rental Rates" from the gross hourly rate shown on the owner-operator listing (without mark-up). The determined hourly wage will be compared to the prevailing wage rate, plus fringe benefits, for the applicable craft or classification determine compliance.

The following factors are considered when determining whether an owner-operator is an independent contractor or an employee of the Contractor:

1. If review of payroll records show that deductions for social security taxes or State unemployment insurance taxes are withheld for the owner-operator, it is an indication that the operator is an employee rather than an independent contractor.
2. An employee interview of the owner-operator indicates that the owner-operator is in fact an employee.
3. Truck owner-operators should be the registered owner of the vehicle. The name of the driver should match the name of the registered owner on the Department of Motor Vehicle's registration.
4. If the legal owner is a firm or corporation, and the firm or corporation name is shown on the vehicle registration slip, the driver shall furnish evidence that they are leasing or purchasing the vehicle. If the owner-operator is unable to substantiate purchase or lease of the equipment, the City will disallow use of the owner-operator classification for this truck. Insurance for the vehicle shall be carried in the driver's name. The California identification (CA) number issued by the California Highway Patrol (CHP) shall be in the driver's name.
5. If the equipment owner-operator owns, is leasing, or financing the equipment other than a truck, then the operator shall furnish such evidence. If the owner-operator is unable to substantiate that they own, are purchasing, or leasing the equipment, the Engineer will disallow use of the owner-operator classification for the equipment. The Contractor must establish proof of ownership in cases where there is doubt as to the validity of the owner-operator designation.

7-16 EMPLOYEE INTERVIEW

The Contractor and Subcontractors shall make available all employees and owner operators for labor compliance interviews during work hours. Labor compliance interviews will

be conducted by the Engineer or the California Department of Industrial Relations. The interview shall be conducted on the Work site at a place and for a duration that will permit privacy for the employee and cause the least amount of disruption to the ongoing Work. The Contractor's Representative shall not be present during the interview.

7-17 RECORD DRAWINGS

At the beginning of the Project, one bond copy or blueline print of each applicable Drawing will be issued by the Agency to the Contractor for use in preparing Record Drawings (also called "red line As Built Drawings").

Actual construction conditions shall be accurately and completely recorded on the bond copy or blueline prints as the Project progresses. The Contractor shall update the Record Drawings daily and review the Record Drawings with the Inspector weekly. If the Contractor fails to update Record Drawings, the monthly progress payment will not be processed until the Inspector is satisfied that the Record Drawings have been updated for the month the Contractor is requesting a progress payment. Upon completion of the Work, the Contractor shall sign the Record Drawings and shall submit same to the Agency's Inspector for review and approval. The 5% retention will not be released to the Contractor until the Record Drawings have been submitted to the Agency and approved. If the Contractor has not submitted an accurate copy of the Record Drawings within 30 Calendar Days after completion of the Work, the Agency reserves the right to have the Record Drawings prepared and to deduct all applicable costs incurred from the retention amount.

7-18 RIGHTS IN LAND AND IMPROVEMENTS

Nothing in the Specifications shall be construed to allow the Contractor to make any arrangement with any person to permit occupancy or use of any land, structure, or building within the Project site for any purpose whatsoever, either with or without compensation, in conflict with any agreement between the Agency and any owner, former owner, or tenant of the land, structure, or building.

The street right-of-way shall be used only for purposes that are necessary to perform the Work. The Contractor shall not occupy the right-of-way, or allow others to occupy the right-of-way, for purposes that are not necessary to perform the Work.

The Contractor shall secure at its own expense any area required for plant sites, storage of equipment or materials, or for other purposes if sufficient area is not available to the Contractor within the Contract limits, or at the sites designated on the plans outside the Contract limits.

For the aforementioned uses on private or public property (outside the public right-of-way), the Contractor shall apply for a temporary use permit (TUP) from the City's Planning Division. The Contractor shall not have use of the area until the TUP has been issued. Fees for the TUP will be the responsibility of the Contractor.

The Agency shall provide any required rights of entry at no cost to the Contractor for Work on private property that is shown on the Plans. Such rights of entry do not relieve the Contractor of the need to provide, at its own cost, permits and insurance required of the Contractor by other agencies and organizations.

SECTION 8 – FACILITIES FOR AGENCY PERSONNEL

Field office facilities for Agency Personnel will not be required on this project.

SECTION 9 – MEASUREMENT AND PAYMENT

9-1 MEASUREMENT OF QUANTITIES FOR UNIT PRICE OF WORK

9-1.1 General

Add the following at the end of Subsection 9-1.1:

All items of Work which are not designated on the Bid Schedule by the letters "F" or "LS" or words "Final" or "Lump Sum" shall have final pay quantities measured and paid for in accordance with the Standard Specifications and Special Provisions.

9-2 LUMP SUM WORK

Delete the first sentence of Subsection 9-2 and substitute the following:

Items of Work which are designated by the letters "LS" or the words "Lump Sum" in the Estimated Quantities column of the Bid Schedule shall be paid for at the price indicated in the Bid, unless the dimensions of said Work, as shown on the Plans, are revised by the Engineer. If such dimensions are revised and such revisions result in an increase or decrease in the quantity of such Work, the final payment for said lump sum item will be revised in proportion to the change in dimensions authorized by Change Order.

Add the following at the end of Subsection 9-2:

The Contractor shall submit a Work item breakdown of the Bid, described in the second paragraph of Subsection 9-2, "Lump Sum Work," of the Standard Specifications, within 15 Calendar Days after award of Contract and/or at any other time as required by the Engineer.

No guarantee is made regarding the amount of Work required to complete a lump sum item of Work.

9-2.1 Progress Payments for Lump Sum Items of Work

The word "Complete" in the Estimated Quantities column of the Bid Schedule for a lump sum item of Work shall mean that payment for that item will only be made after all Work for that item has been completed. The "%" symbol in the Estimated Quantities column of the Bid Schedule for a lump sum item of Work shall mean that progress payments for that item will be allowed based on the percentage of completion as determined by the Engineer in each pay period, typically every 30 days (see Subsection 9-3.2 of the Standard Specifications and the Special Provisions).

9-3 PAYMENT

9-3.1 General

Delete the first sentence of Subsection 9-3.1 and substitute the following:

For unit items of Work, the estimated quantities listed on the Bid Schedule will not govern the final payment.

Delete the eighth paragraph of Subsection 9-3.1 and substitute the following:

Warranty periods shall be in accordance with Subsection 6-8, "Warranty of Work and Materials," of the Special Provisions.

Add the following at the end of the ninth paragraph of Subsection 9-3.1:

In the event that a stop payment notice is filed with the Agency, an amount equal to 125% of the total of the amount claimed in the stop payment notice will be withheld by the Agency until the stop payment notice has been released. Alternatively, the Contractor may file with the Agency a bond, on a form approved by the Agency, executed by one or more corporate California Admitted surety insurers, in an amount equal to one hundred and twenty-five percent (125%) of the claim stated in the stop payment notice conditioned for the payment of any sum which the stop payment notice claimant may recover on the claim together with its costs of suit in the action. Upon the Agency's acceptance of such bond, the Agency shall not withhold money from the Contractor on account of the stop payment notice. The surety(ies) upon the stop payment notice release bond shall be different than, and jointly and severally liable to the stop payment notice claimant with, the Payment Bond surety(ies). A stop payment notice is not effective unless given before the expiration of whichever of the following time periods is applicable: (1) If a notice of completion, acceptance, or cessation is recorded, 30 days after the recordation; (2) If a notice of completion, acceptance, or cessation is not recorded, 90 days after cessation or completion.

Delete the tenth paragraph of Subsection 9-3.1 and substitute the following:

Not later than sixty (60) days from the date of Final Acceptance, the five percent (5%) deducted and retained from each progress estimate (see Subsection 9-3.2 of the Standard Specifications and the Special Provisions) by the Agency will be paid to the Contractor except such amounts as are required by law to be withheld by properly executed and filed notices to stop payment, or as may be authorized by the Contract to be further retained.

The Contractor understands that Final Acceptance does not generally occur for one to two (1-2) weeks after Final Completion. Final Completion is the stage of performance of the Work when:

1. All Work required by the Contract Documents has been fully completed in compliance with the Contract Documents and all Applicable Laws including, but not limited to, correction or completion of all punch list items; and
2. The Contractor has delivered to the Agency all closeout documentation required by the Contract Documents, including, but not limited to:
 - a. Duly completed and executed forms of Conditional Waiver and Release Upon Final Payment and Declaration to Procure Final Payment from the Contractor, Subcontractors of any tier, suppliers, and other persons eligible to file stop notices in connection with the Work, covering the final payment period;

- b. Duly completed and executed forms of Unconditional Waiver and Release Upon Final Payment and Declaration to Procure Final Payment from the Contractor, Subcontractors of any tier, suppliers, and other persons eligible to file stop notices in connection with the Work, covering the previous payment period;
- c. Record Drawings / As-Built Drawings;
- d. Consent of surety(ies) to final payment;
- e. Special warranties, if applicable;
- f. Operation and maintenance manuals and/or training manuals, if applicable; and
- g. Any other documentation required by the Specifications.

9-3.1.1 Final Pay Quantities

When the estimated quantities for a specific portion of the Work are designated on the Bid Schedule as final pay quantities with the letter "F" or the word "Final," said estimated quantities shall be the actual quantities for which payment for such specific portion of the Work will be made, unless the dimensions of said portions of the Work shown on the Plans are revised by the Engineer. If such dimensions are revised and such revisions result in an increase or decrease in the quantities of such Work, the final quantities for payment will be revised in the amount represented by the changes in the dimensions authorized by Change Order.

The estimated quantities designated on the Bid Schedule with the letter "F" or the word "Final," are approximations only, and no guarantee is made that the quantities which can be determined by computations based on the details and dimensions shown on the Plans will equal the estimated quantities. No adjustment in the Contract Price will be made in the event that quantities based on subsequent computations or measurements do not equal the estimated final pay quantities.

9-3.2 Partial and Final Payment

Delete the first, second, third, and fourth paragraphs of Subsection 9-3.2 and substitute the following:

Except as otherwise provided in Subsection 9-2.1 "Progress Payments for Lump Sum Items of Work," of the Special Provisions, the Contractor will be entitled to no more than one progress payment per month. Thirty (30) Calendar Days prior and as a condition to each progress payment, the Contractor shall submit to the Engineer a detailed estimate and invoice of the total quantity and value of Work completed since the cut-off date for the previous progress payment. The Engineer shall make the final determination as to the actual quantity and value of Work completed for which payment will be made. From each progress payment, **five percent (5%)** will be deducted and retained by the Owner until Final Payment is made in accordance with Subsection 9-3.1 of the Standard Specifications and the Special Provisions; the remainder, less the amounts needed to satisfy outstanding stop notices, will be paid to the Contractor.

No progress payment to the Contractor or its sureties will constitute a waiver of the liquidated damages specified in the Agreement. Liquidated damages, if any, will be deducted from earned progress payments due the Contractor.

This Contract is subject to the following provisions of California Public Contract Code Section 20104.50 which provides as follows:

- a. (1) It is the intent of the Legislature in enacting Subsection 9-3.2 of the Standard Specifications and the Special Provisions to require all local governments to pay their contractors on time so that these contractors can meet their own obligations. In requiring prompt payment by all local governments, the Legislature hereby finds and declares that the prompt payment of outstanding receipts is not merely a municipal affair, but is, instead, a matter of statewide concern.
- (2) It is the intent of the Legislature in enacting this article to fully occupy the field of public policy relating to the prompt payment of local governments' outstanding receipts. The Legislature finds and declares that all governmental officials, including those in local government, must set a standard of prompt payment that any business in the private sector that may contract for services should look toward for guidance.
- b. Any local agency which fails to make any progress payment within thirty (30) days after receipt of an undisputed and properly submitted payment request from the Contractor or construction Contract shall pay interest to the Contractor equivalent to the legal rate set forth in subdivision (a) of § 685.010 of the Code of Civil Procedure.
- c. Upon receipt of a payment request, each local agency shall act in accordance with both of the following:
 - (1) Each payment request shall be reviewed by the local agency as soon as practicable after receipt of the purpose of determining that the payment request is a proper payment request;
 - (2) Any payment request determined not to be a proper payment request suitable for payment shall be returned to the Contractor as soon as practicable, but not later than seven (7) days, after receipt. A request returned pursuant to this Subsection of the Standard Specifications and the Special Provisions shall be accompanied by a document setting forth in writing the reasons why the payment request is not proper.
- d. The number of days available to a local agency to make a payment without incurring interest pursuant to this Subsection of the Standard Specifications and the Special Provisions shall be reduced by the number of days by which a local agency exceeds the seven-day return requirement set forth in paragraph (2) of subdivision (c), above.
- e. For purposes of this Article:

Attachment: Special Provisions PCS HSG GR-JFK RENO (2845 : APPROVE AND EXECUTE AGREEMENT FOR THE INSTALLATION OF A

(1) A "local agency" includes, but is not limited to, a city, including a charter city, a county, and a city and county, and is any public entity subject to this part.

(2) A "progress payment" includes all payments due contractors, except that portion of the final payment designated by the Contract as retention earnings.

(3) A payment request shall be considered properly executed if funds are available for payment of the payment request, and the Financial Officer of the local agency does not delay the payment due to an audit inquiry.

f. Each local agency shall require that this article, or a summary thereof, be set forth in the terms of any Contract subject to this article.

Add the following to the end of the fifth paragraph of Subsection 9-3.2:

At the request and sole expense of the Contractor, securities equivalent to the amount withheld shall be deposited with the City, or with a state or federally chartered bank in California as escrow agent, who shall pay such monies to the Contractor after satisfactory completion of the Contract. Securities eligible for investment under this Subsection of the Standard Specifications and the Special Provisions shall include those listed in Section 16430 of the Government Code, bank or savings and loan certificates of deposit, interest-bearing demand deposit accounts, and standby letters of credit. The Contractor shall be the beneficial owner of any securities substituted for monies withheld and shall receive any dividends and interest thereon. Alternatively, the Contractor may request that the Agency, at the expense of the Contractor, make payment of retention earned directly to the escrow agent. Notwithstanding the foregoing, such contractor shall have thirty (30) Calendar Days following award of the Contract to submit a written request to the Agency to permit the substitution of securities for retention or payment to an escrow agent; failure to do so shall be deemed a waiver of the right. If the Contractor requests such substitution or payment to escrow, the Agency, the Contractor, and escrow agent shall execute a separate agreement regarding such substitution or payment to escrow.

See Subsection 9-3.1 of the Standard Specifications and the Special Provisions regarding timing of Final Payment.

9-3.3 Delivered Materials

Delete Subsection 9-3.3 in its entirety and substitute the following:

Unless included in the Bid Schedule, or unless otherwise called for in these Special Provisions, no payment will be made for materials or equipment delivered but not incorporated in the Work.

9-4 PROMPT PROGRESS PAYMENT TO SUBCONTRACTORS

The Contractor's attention is directed to Business and Professions Code Sections 7108.5 and 7108.6 concerning prompt payment to Subcontractors and transportation charges submitted by dump truck drivers. The Contractor shall pay all Subcontractors for and on account of Work performed by such Subcontractors within seven (7) Calendar Days after receipt of progress payment from the Agency and within seven (7) Calendar Days after receipt of retention from the Agency. The Contractor shall pay all transportation charges submitted by a

duly authorized motor carrier of property in dump truck equipment by the 20th day following the last day of the calendar month in which the transportation was performed, if the charges, including all necessary documentation, are submitted by the fifth day following the last day of the calendar month in which the transportation was performed.

If there is a good faith dispute over all or any portion of the amount due on a progress payment from the Contractor to a Subcontractor or dump truck driver, the Contractor may withhold no more than one hundred and fifty percent (150%) of the disputed amount.

9-5 RETENTION WITHHELD FROM SUBCONTRACTORS

9-5.1 This Contract is subject to the following provisions of Public Contract Code Section 7200, which provides as follows:

- A. Subsection 9-5 of the Special Provisions shall apply with respect to all Contracts entered into on or after January 1, 1999, between a public entity and an original contractor, between an original contractor and a Subcontractor, and between all Subcontractors thereunder, relating to the construction of any public Work of improvement.
- B. For purposes of Subsection 9-5 of the Special Provisions, "public entity" means the state, including every state agency, office, department, division, bureau, board, or commission, a city, county, city and county, including chartered cities and chartered counties, district, special district, public authority, political subdivision, public corporation, or nonprofit transit corporation wholly owned by a public agency and formed to carry out the purposes of the public agency.
- C. In a Contract between the original contractor and a Subcontractor, and in a Contract between a Subcontractor and any Subcontractor thereunder, the percentage of the retention proceeds withheld may not exceed the percentage specified in the Contract between the public entity and the original contractor.
- D. When a performance and payment bond is required in the solicitation for bids, item (C) above shall not apply to either of the following:
 1. The original contractor, if the Subcontractor fails or refuses to provide a performance and payment bond issued by an admitted surety insurer, to the original contractor.
 2. The Subcontractor, if a Subcontractor thereunder fails or refuses to provide a performance and payment bond issued by an admitted surety insurer, to the Subcontractor.
- E. No party identified in item (C) above shall require any other party to waive any provision of Subsection 9-5 of the Special Provisions.
- F. In the event that the Contractor elects to substitute securities in lieu of retentions, the Contractor may withhold from its Subcontractors, who have not elected to substitute securities in lieu of retentions, the amount of retentions that would have otherwise been withheld.

AGENCY SPECIAL PROVISIONS

PART 2

TECHNICAL PROVISIONS 0702

JOHN F. KENNEDY VETERANS MEMORIAL PARK – RESTROOM IMPROVEMENTS

TABLE OF CONTENTS:

| | |
|------------------------------|---------------------------------|
| DIVISION 1 | GENERAL REQUIREMENTS |
| 01000 | MOBILIZATION |
| 01300 | SUBMITTALS |
| | |
| DIVISION 2 | SITE CONSTRUCTION |
| 02110 | SITE CLEAR & GRUB |
| 02221 | DECOMPOSED GRANITE |
| 02441 | IRRIGATION |
| 02445 | TEMPORARY CHAIN LINK FENCING |
| 02470 | SITE FURNISHINGS |
| 02480 | PLANTING |
| | |
| DIVISION 3 | CONCRETE |
| 03010 | CONCRETE |
| 03310 | FOOTINGS & FOUNDATIONS |
| 03380 | CONCRETE CURING |
| | |
| DIVISION 4 | RESTROOM BUILDING |
| 13000 | PREFABRICATED RESTROOM BUILDING |
| | |
| DIVISION 16 | ELECTRICAL |
| Provided on Electrical Plans | |

DIVISION 1

SECTION 01000 - MOBILIZATION

PART 1 - GENERAL

1.01 STANDARD SPECIFICATIONS: The provisions of the "Standard Specifications for Public Works Construction" shall apply except as modified herein.

1.02 SCOPE: The Work of this Section shall consist of furnishing all labor, materials, equipment, appliances and services necessary for the execution and completion of all Mobilization Work as shown on the Plans and as described in the Specifications including, but not necessarily limited to, the following:

- Preparatory operations including, but not limited to those efforts necessary for the movement of personnel, equipment, supplies, and incidentals to the Work site;
- All other operations which must be performed or costs incurred prior to beginning Work on the site;
- Provision and installation of Construction Fence per Technical Specifications Section 02445 Temporary Chainlink Fencing;
- Provision of temporary utilities;
- Secure all required permits;
- Obtain temporary construction water & electrical service
- Submittals per Special Provisions Section 2-5.3 Submittals and Technical Specifications Section 01300 Submittals.

1.03 RELATED WORK:

Bonds and insurance per contract specifications.

1.04 SUBMITTALS: As a part of mobilization, all submittals as specified in various individual Sections of the Specifications shall be forwarded to the Agency Representative in the format specified in Technical Specifications Section 01300 Submittals and within the time-frames specified in Special Provisions Section 2-5.3 Submittals. Submittals shall include all Materials Lists, Catalog Cuts, Shop Drawings, material and color samples, and Construction Schedule all as specified.

PART 2 - MATERIALS

2.01 TEMPORARY UTILITIES: The permanent potable domestic water meter is already in place and available for use on the Project. Contractor shall furnish temporary water (if need exceeds safe rate of flow through existing water meter), and power complete with connecting piping, wiring, lamps, meters and similar equipment as required for the Work. Install, maintain, and remove temporary lines upon completion of the Work. All expenses in connection with temporary services and facilities shall be paid for by Contractor.

PART 3 – EXECUTION

3.01 GENERAL:

A. Payment: Payment for mobilization will be at the lump sum price bid for mobilization. Payment shall include full compensation for furnishing all labor, materials, tools, equipment and incidentals, and for doing all the Mobilization and De-mobilization Work as herein specified. The 10% retention shall apply to all Mobilization Work.

3.02 CLEAN-UP: Contractor shall provide trash receptacles for collecting debris, shall remove debris from the job site at regular intervals not less than weekly and shall dispose of same in a legal manner.

END OF SECTION

SECTION 01300 - SUBMITTALS**PART 1 - GENERAL**

1.01 STANDARD SPECIFICATIONS: The provisions of the "Standard Specifications for Public Works Construction" shall apply except as modified herein.

1.02 SCOPE: The Work of this Section shall consist of furnishing all labor, materials, equipment, appliances and services necessary for the execution and completion of all Submittals Work as shown on the Plans and as described in the Specifications including, but not necessarily limited to, the following:

- Preparation of Submittals Schedule;
- Submittals Planning;
- Submittals Preparation, Distribution and Transmittal, to include all of the following:
 - Product Data (Catalog Cuts);
 - Materials Lists;
 - Samples;
 - Record Drawings;
 - Turn-over Items;
- Submittals Schedule updating and distribution;

1.03 RELATED WORK:

Shop Drawing Submittals

Spec. Prov. Section 2-5.3.3

Contractor's Construction Schedule

Spec. Prov. Section 6-1

1.04 SUBMITTAL PLANNING:

A. Processing Lead Time: Allow sufficient review time so that installation will not be delayed as a result of the time required to process submittals, including time for resubmittals.

1. Allow two (2) weeks for initial review. Allow additional time if processing must be delayed to permit coordination with subsequent submittals. The Agency Representative will promptly advise Contractor when a submittal being processed must be delayed for coordination.
2. If a resubmittal is necessary due to corrections or revisions, process the resubmittal in the same manner as the initial submittal.
3. Allow two (2) weeks for processing each resubmittal.
4. No extension of Contract Time will be authorized because of failure to transmit submittals to the Agency Representative sufficiently in advance of the Work to provide the two week processing time specified.

B. Coordination and Completeness:

1. Contractor shall coordinate preparation and processing of submittals with the performance of the related Work. Transmit each submittal allowing sufficient lead time to obtain appropriate reviews and approvals and to avoid delays in the related Work.
2. Coordinate the submittal date for each submittal with the lead time needed for fabrication, purchasing, testing, delivery, review of other related submittals, and related Work that require sequential processing/completion.
3. Coordinate the transmittal dates for each different type of submittal so processing will not be delayed. Ensure concurrent transmittal of submittals for related portions of the Work that need concurrent review to allow the Architect to verify that a coordinated work effort is being provided. Agency and Architect each reserves the right to withhold action on a submittal requiring coordination with other submittals until related submittals are received.
4. Contractor is responsible to verify completeness of all submittals. Incomplete submittals will be rejected.

1.05 SUBMITTALS SCHEDULE:

- A. Concurrently with the development of Contractor's Construction Schedule (per Special Provisions Section 6-1 CONSTRUCTION SCHEDULE AND COMMENCEMENT OF WORK), prepare a complete "Submittals Schedule" for all submittals. Submit the Submittals Schedule together with the Construction Schedule at the Pre-Construction meeting.
1. Coordinate the Submittals Schedule with all subcontractors, with the schedule of values, with the Materials Lists and with the Construction Schedule.
 2. Itemize items on the Submittals Schedule in the chronological sequence planned for submission; include all submittals required by the Contract Documents. Provide the following information:
 - a) Scheduled date for the initial submittal for each item.
 - b) Related Specification Section number.
 - c) Submittal category (i.e. Product Data, Samples, Record Documents, Shop Drawing, etc.).
 - d) Name of subcontractor or supplier as applicable.
 - e) Description of the portion of the Work covered by the submittal.
 - f) Record successive date(s) of any resubmittal(s).
 - g) Record date of Agency's approval of each submittal.
- B. Submittals Schedule Updating: Update the Submittals Schedule after each meeting or activity where revisions have been recognized or made.

- C. Distribution: Following receipt of review comments to the initial Submittals Schedule, on a monthly basis thereafter issue updated copies of the Submittals Schedule. Distribute copies to the Architect, the Agency Representative, all subcontractors, and all other parties required to comply with scheduled submittal dates. Keep an up to date copy of the Submittals Schedule posted in the Construction Office. Parties may be deleted from the distribution upon completion of all portion(s) of the Work assigned to such parties and such parties are no longer involved in construction activities.

1.06 SUBMITTALS PREPARATION AND TRANSMITTAL:

- A. Preparation: Place a permanent label or title block on each submittal for identification. Indicate the name of the entity that prepared each submittal on the label or title block.
1. Provide a space approximately 4" x 5" on the label or beside the title block on Shop Drawings to record Contractor's review and approval markings and the action taken.
 2. Include the following information on the label for processing and recording action taken.
 - a) Project name.
 - b) Date.
 - c) Name and address of Architect.
 - d) Name and address of Contractor.
 - e) Name and address of subcontractor (as applicable).
 - f) Name and address of supplier.
 - g) Name of manufacturer.
 - h) Number and title of related Specification Section.
 - i) Drawing number and detail references, as appropriate.
- B. Transmittal: Forward one electronic copy of each submittal appropriately for transmittal and handling. Transmit each submittal from Contractor to the Agency Representative using a transmittal form. Submittals received from sources other than Contractor may be returned without action. If a submittal is rejected, submit one electronic copy of the resubmittal.
1. When transmitting submittals, record relevant information and requests for data on the transmittal form. Include a Contractor's certification that information submitted complies with the Contract Document requirements as a part of each submittal. If the submittal is not in full accordance with the Contract Documents, record specific deviations from the Contract Document requirements, including minor variations and limitations, either on the transmittal form or on a separate attached sheet that is referenced on the form.
 2. Transmittal Form: Use AIA Document G 810, or Agency approved equal.

1.07 SUBMITTALS PROCESSING AND DISTRIBUTION:

- A. Processing: Upon receipt of the submittals, the Agency Representative will retain one copy and forward an electronic copy to the appropriate Designer (Architect/Engineer) who will retain one, and will return an electronic copy marked with action taken. Electronic copies will be forwarded to the appropriate designer who will return an electronic copy with action taken.
1. Except for submittals for record information or similar purposes, where action and return is required or requested the appropriate Designer (Agency, Architect, or Engineer) will review each submittal, mark to indicate action taken, and return promptly.
 2. Verification of the submittals compliance with characteristics specified in the Contract Documents is Contractor's responsibility.
 3. Action Stamp: The appropriate Designer (either Agency, the Architect, or the Engineer) will stamp each submittal with a uniform, self-explanatory action stamp. The stamp will be appropriately marked, as follows, to indicate the action taken:
 - a) "No Exception Taken": When submittals are marked "No Exception Taken," that part of the Work covered by the submittal may proceed.
 - b) "Make Corrections Noted": When submittals are marked "Make Corrections Noted," that part of the Work covered by the submittal may proceed provided it complies with the notations and corrections marked on the submittal as well as the requirements of the Contract Documents.
 - c) Returned for Resubmittal: Submittals may be returned for resubmittal for various reasons. When a submittal is marked either "Submit Specified Item," "Rejected," or "Revise and Resubmit," Contractor shall not proceed with any part of the Work covered by the submittal, including purchasing, fabrication, delivery, or any other associated activity. Instead, the submittal shall either be revised to comply with the Contract Documents and resubmitted, or a new submittal shall be prepared in accordance with the notations and submitted; resubmit without delay.
 - d) Other Action: Where a submittal is primarily for information or record purposes, special processing or other activity, the submittal will be returned, marked "Action Not Required".
 - e) Contractor shall repeat the submittal process as specified above for all submittals as necessary to obtain an action mark that will allow the Work to proceed.
- B. Distribution: Upon receipt of marked copies of the submittals from the appropriate Designer, the Agency Representative will forward four hard copies or one electronic copy of the marked submittal to the Prime Contractor for further distribution to the Subcontractor(s) and/or Supplier(s).

1. Do not proceed with the Work until an appropriately marked copy of the applicable submittal has been received from Agency and is in the installer's possession.
2. Do not permit use of unmarked copies of submittals in connection with construction.
3. Contractor shall not permit submittals marked "Rejected, "Submit Specified Item", or "Revise and Resubmit" to be used at the Project site, or elsewhere where Work is in progress.

1.08 PRODUCT DATA ("CATALOG CUTS"):

- A. Submittal: Assemble Product Data submittals into a single submittal package for each construction trade or system (e.g. Plumbing, Electrical Lighting, Concrete, HVAC, etc.). Submittals shall consist of one electronic copy. Product Data submittals shall include all available printed information such as manufacturer's installation instructions, catalog cuts, standard color charts, roughing-in diagrams and templates, standard wiring diagrams and performance curves. Where Product Data must be specially prepared because standard printed data is not suitable for use, submit as "Shop Drawings."
1. Mark the copy to show applicable choices and options. Where printed Product Data includes information on several products, some of which are not required, mark copies to delete inapplicable information. Product Data submittals, as a minimum, shall include the following information:
 - a) Manufacturer's printed recommendations.
 - b) Compliance with recognized trade association standards.
 - c) Compliance with recognized testing agency standards.
 - d) Application of testing agency labels and seals.
 - e) Notation of dimensions verified by field measurement.
 - f) Notation of coordination requirements.
 2. Do not submit Product Data until Contractor has confirmed the product's compliance with requirements of the Contract Documents.

1.09 SAMPLES:

- A. General: Submit full-size, fully fabricated Samples cured and finished as specified, in the quantity specified in the respective Technical Specification section, and physically identical with the material or product proposed. Where quantities are not specified in the Technical Specification, submit a minimum of three samples, one will be returned marked with the action taken. Samples include partial sections of manufactured or fabricated components, cuts or containers of materials, color range sets, and swatches showing color, texture and pattern.

1. Mount, display, or package Samples in the manner specified to facilitate review of qualities indicated. Prepare Samples Submittals to match the Architect's Sample when available. Include the following:
 - a) Generic description of the Sample.
 - b) Sample source.
 - c) Product name or name of manufacturer.
 - d) Certification of compliance with the specified standards.
 - e) Availability and delivery time.

2. Submit Samples for review of kind, color, pattern, and texture, for a final check of these characteristics with other elements, and for a comparison of these characteristics between the final submittal and the actual component as delivered and installed. Where variation in color, pattern, texture or other characteristics are inherent in the material or product represented, submit multiple units (not less than 3), that show approximate limits of the variations.

3. Preliminary submittals: Where Samples are for selection of color, pattern, texture or similar characteristics from a range of standard choices, submit a full set of choices for the material or product. Preliminary submittals will be reviewed and returned with the appropriate Designer's mark indicating selection and other action.

4. Maintain appropriately marked sets of Samples, as returned by Agency, at the Project site for quality comparisons throughout the course of construction.

B. Distribution of Samples: If additional sets of samples are needed for distribution to subcontractors, manufacturers, fabricators, suppliers, installers, and others as required for performance of the Work, Contractor shall submit samples in sufficient quantities for such distribution. Do not distribute unmarked copies of sample to others involved in the Work.

1.10 MATERIALS LISTS:

A. Submittal Requirements: Submitting a catalog number and manufacturer's name as a materials list stating that the items will be furnished to meet the Specifications will not be acceptable. Contractor shall submit a complete materials list for approval by the Agency Representative prior to performing any Work. Catalog data and full descriptive literature must be submitted whenever the use of items different than those specified is requested. Notarized certificate must be submitted by plastic pipe and fitting manufacturer indicating that material complies with the Project Specifications, unless material has been previously approved and used on other projects by Agency.

Material list shall be submitted in a format similar to the following:

| <u>Item Description</u> | <u>Manufacturer</u> | <u>Model No.</u> |
|-------------------------|---------------------|------------------|
| 1. Pressure Supply Line | Lasco | Sch. 40 |

DIVISION 2

SECTION 02110 - SITE CLEAR AND GRUB

PART 1 - GENERAL

1.01 RELATED DOCUMENTS:

The provisions of the "Standard Specifications for Public Works Construction" shall apply except as modified herein.

1.02 SCOPE OF WORK:

Furnish all material, equipment and labor necessary to perform all clearing and grubbing work complete, including but not limited to the following:

Protection of trees indicated on drawings to remain.

Clearing and grubbing of all vegetation from site work areas.

Removal and disposal of all deleterious materials.

Furnishing, developing, applying and providing dust control watering equipment as required for the project.

1.03 RELATED WORK SPECIFIED ELSEWHERE:

| | |
|---------------------|---------------|
| Planting: | Section 02480 |
| Irrigation systems: | Section 02441 |

1.04 RESPONSIBILITY AND COORDINATION:

Contractor shall secure and maintain all required permits and licenses, and pay all fees necessary to legally complete the work of this section.

Contractor shall notify utility companies for all utilities to be cut off, modified or relocated, and shall maintain and protect all active utilities.

Contractor shall coordinate all work with the City of Moreno Valley Parks & Community Services Department in an effort to avoid any conflicts with the parks maintenance schedules.

1.05 PROTECTION AND SAFETY:

Contractor shall provide signs in necessary places to exclude persons, except those connected with the work, from entering the working area. Contractor is responsible for preventing unauthorized persons from entering working area. Protect the project site and adjacent properties from mud and water accumulated due to Contractor's operations, or

water that enters the project site from any other source.

PART 2 - MATERIALS - Not applicable.

PART 3 - EXECUTION

3.01 GENERAL REMOVAL WORK:

Removal work shall be carefully done to avoid damage to all existing facilities to remain.

3.02 SITE CLEARANCE AND DISPOSAL:

Clear the sites to be improved of grass, shrubs, weed growth, rubbish and debris, etc., that are to be removed for construction of the improvements shown on the construction plans. Roots three inches in diameter and larger, rocks and broken masonry larger than 1 inch in the greatest dimension, shall be removed to a minimum depth of 12" below finished grade.

All deleterious materials shall be disposed of off the site in a legal manner by the Contractor, who shall make all necessary arrangements and pay all related costs.

Miscellaneous existing underground facilities, drainage devices, secondary water lines, cables, abandoned oil and water lines, leaching fields, irrigation pipes, wiring, etc, located 12 inches or more below proposed finish grade may be abandoned in place or removed as necessary for proper completion of the work. All miscellaneous active lines that are uncovered during the grading operations shall be protected.

3.03 UTILITIES:

Inactive or abandoned utilities shall be disconnected, removed, and plugged or capped subject to the local governing ordinances.

Should the Contractor encounter any existing underground utilities not shown on the drawings, he shall at once notify the Engineer who will determine further procedure.

3.04 DEBRIS BURNING:

Burning of debris will not be permitted.

3.05 DUST CONTROL:

Dust shall be kept to a minimum during site clearing operations by means of wetting the site or other approved method. Wash down all existing sidewalks and roadways on and off the site after all operations are complete.

END OF SECTION

SECTION 02221 - DECOMPOSED GRANITE**PART 1 - GENERAL****1.01 WORK INCLUDED:**

- A. Base Course
- B. Crushed Aggregate Paving
- C. Organic Binder for Crushed Aggregate

1.02 APPROVALS:

- A. Submit 10 pound sample of decomposed granite for approval prior to ordering delivery. Attach supplier's certification of testing.
- B. Subgrade shall be approved prior to placing.

1.03 DELIVERY, STORAGE AND HANDLING:

- A. Protect stabilized crushed aggregate mix from contamination. Store under cover.

1.04 SEQUENCING:

- A. Do not install work specified in this Section prior to acceptance of earth moving.
- B. Coordinate work specified in this Section with work specified in other Sections to minimize cutting of and operation of heavy equipment over installed stabilized crushed aggregate paving.
- C. Do not install stabilized crushed aggregate surfacing when subbase is wet at saturated filed capacity.

PART 2 – MATERIALS**2.01 BASE COURSE MATERIALS:**

- A. Comply with MTO OPSS 1010 – “Material Specification for Aggregates – Granular A, B, M and Select Subgrade Material” specification for Granular A material.

2.02 CRUSHED AGGREGATE MATERIALS:

- A. Crushed aggregate material shall consist of sound, angular, durable particles.
- B. Gradation, in accordance with ASTM C136:

| Sieve | Sieve Size (mm) | Percent Passing |
|-------|-----------------|-----------------|
| ½" | 12.7 | 100% |
| 3/8" | 9.51 | 90-100% |
| 4 | 4.76 | 50-100% |
| 30 | 0.595 | 25-55% |
| 100 | 0.149 | 10-25% |
| 200 | 0.074 | 5-18% |

- C. Aggregate color shall be selected from a pre-approved material pallet from Gail Materials (951) 667-6106, www.gailmaterials.net.

2.03 ORGANIC BINDER:

- A. Organic-Lock™ self-healing organic binder by Gail Materials, Corona, CA; (951) 667-6106, www.gailmaterials.net.
- B. Requests for substitutions will be considered in accordance with provisions of Section 01 25 00 [01630] Substitution Procedures.

2.04 PRE-BLENDED ORGANIC LOCK™ AGGREGATE PAVING MIX:

- A. Crushed aggregate material with Organic-Lock™ binder using a pug mill that includes a weigh-belt feeder.
- B. Mix rate of Organic-Lock depends on the selected material as well as the application and shall be determined by Gail Materials.
- C. Material shall arrive to site pre-wetted from manufacturer.

2.05 ACCESSORIES:

- A. Water: Free from contaminants that would discolor or be deleterious to stabilized aggregate paving.

PART 3 - EXECUTION

3.01 EXAMINATION

- A. Examine grading and subsoil conditions. Do not proceed until conditions are acceptable.

3.02 PREPARATION OF SUBGRADE:

- A. Excavate to depth required so that finish grade can be established as noted on plans.

- B. Compact subgrade to 90% Modified Proctor Density. Excavate soft and unstable areas of subgrade that cannot be compacted to standard noted, fill and compact with approved granular material.

3.03 BASE COURSE:

- A. Place base course material over subgrade to depths and dimensions shown on drawings in maximum (6") lifts compacted to 90% Modified Proctor Density.

3.04 PRE-BLENDED ORGANIC LOCK™ AGGREGATE SURFACING:

- A. Install Organic Lock™ Aggregate Paving to a compacted depth of 4 inches.
- B. Pre-wetted Organic Lock Aggregate Paving can be installed in one lift. The moisture percentage in the pre-wetted Organic Lock Aggregate Paving will be determined by Gail Materials and will depend on selected aggregate.
- C. For applications that are not pre-wetted by Gail Materials the Organic Lock Aggregate Paving will be delivered dry. Gail Materials will calculate the required gallons of water to be added per ton of selected material in order to reach the ideal moisture percentage for installation. In order to ensure that water is being applied correctly the Organic Lock Aggregate Paving shall be bucket blended or equal prior to spreading. Gail Materials does not recommend installing Organic Lock Aggregate Paving in place and then water in either lifts or from the surface down.
- D. Depending on weather conditions, the time required to allow the material to set-up before it can be compacted varies. Generally, this time period is between 6 and 48 hours. The top layer should be firm and not sticky. Compaction can be when you can walk on the material without significantly sinking in and material to further dry. Do not allow the material to completely dry out.
- E. Where applicable, make 4-6 passes using a 1-10 ton double or single static drum roller, or equivalent. Do not use a vibratory compactor or vibratory setting on the compactor. The contractor shall select the proper size roller for the appropriate application.
- F. After final compaction, the surface shall be true to elevation and shall not vary by more than (1/4") tested with a straight edge at any location on the surfaces. Surfaces can either be crowned at a minimum of 2% and/or installed with a cross slope of minimum 1%.
- G. Compaction testing shall not be conducted until the Organic Lock Aggregate Paving has been allowed to thoroughly dry and cure.

3.05 ADJUST AND CLEAN:

- A. All paved areas or adjacent surface shall be brushed clean and excess materials

shall be removed from the work site and disposed of in an approved dump location.

3.06 PROTECTION:

- A. Do not allow traffic on stabilized crushed aggregate paving after placement or until compacted stabilized crushed aggregate paving has fully cured. This time may vary depending on weather conditions.
- B. Protect stabilized crushed aggregate paving surface from damage until Project completion. Repair damaged areas to match specified requirements.

3.07 MAINTENANCE AND REPAIRS:

- A. Loose aggregate will appear on the surface over time and is a natural occurrence. If excess material becomes loose, redistribute the material over the surface, water thoroughly and re-compact (if necessary, with a minimum 1-ton drum roller).
- B. To repair, excavate damaged area and scarify exposed stabilized crushed aggregate paving. Pre-blend replacement crushed aggregate material with Organic-Lock™ Aggregate Paving at the specified rate. Apply material to the excavated area and compact. Thoroughly water the material and allow the material to cure, but not completely dry out. Compact the material again, ensuring that the final grade and crown are maintained. Do not use a vibratory compactor, unless approved by the Engineer.

END OF SECTION

SECTION 02441 - IRRIGATION

PART I - GENERAL

1.01 SCOPE:

The work required is indicated on the drawings and includes, but is not limited to, lawn and shrub irrigation systems and remote control valves.

1.02 SUBMITTALS:

A. Materials List:

1. Complete material list shall be submitted prior to performing any work. Catalog data and full descriptive literature must be submitted whenever the use of the items different than those specified is requested. Notarized certificate must be submitted by plastic pipe and fitting manufacturer indicating that material complies with specifications, unless material has been previously approved.
2. Material list shall be submitted using the following format (double spaced between each item):

| Item | Description | Manufacturer | Model |
|------|--------------------|-------------------|--------------|
| 1. | Pressure Pipe | Lasco | Class 200 |
| 2. | Pop Up Spray | Rainbird | 1806-SAM-PRS |
| Etc. | Etc. | Etc. | Etc. |

B. Record Drawings:

1. Record accurately on one set of contract drawings all changes in the work constituting departures from the original contract drawings.
2. The changes and dimensions shall be recorded in a legible and workmanlike manner to the satisfaction of the Agency Representative. Prior to final inspection of work, submit record drawings to Agency Representative for approval.
3. Dimensions from two permanent points of reference (buildings, monuments, sidewalks, curbs, pavement, etc.). Data to be shown on record drawing shall be recorded day to day as the project is being installed. All lettering on drawings shall be minimum 1/8 inch in size.
4. Show locations and depths of the following items:
 - a. Point of connection.
 - b. Routing of sprinkler pressure lines (dimension maximum 100 feet along routing)
 - c. Gate valves.
 - d. Sprinkler control valves.
 - e. Quick coupling valves.
 - f. Routing of control wires.
 - g. Related equipment (as may be directed).

5. Maintain record drawings on-site at all times. Upon completion of work, transfer all as-built information and dimensions to reproducible sepia prints.

1.03

INSPECTIONS:

A. Inspections Will Be Required For:

1. Coverage test.
2. Final inspection/start of maintenance. Final inspection shall be performed by the Agency in the presence of owner or his representative.
3. Final acceptance.

B. Inspection Requests:

Contractor shall notify the Engineer in advance for requesting all inspections as follows:

System layout - 36 hours (1-2 working days)
 Coverage Tests - 36 hours (1-2 working days)
 Final Inspection - 48 hours (2 working days)

When inspections have been conducted by other than the Agency Representative, the Contractor shall show evidence of when and by whom these inspections were made.

No inspection will commence without "record" prints. In the event the Contractor calls for an inspection without up to date "record" prints, without completing previously noted corrections, or without preparing the system for inspection, the inspection will be canceled and the Contractor back charged for the direct costs of all Agency personnel time and consultant time lost.

C. Closing In Uninspected Work:

Do not allow or cause any of the work of this section to be covered up or enclosed until it has been inspected, tested, and approved by the Engineer.

D. Coverage Test:

When the sprinkler system is completed, Contractor shall perform a coverage test in the presence of the Agency Representative and the Landscape Architect to determine if the water coverage for planting areas is complete and adequate. This test shall be accomplished before any planting.

1.04 TURNOVER ITEMS:

A. Controller Charts:

1. Record drawings must be approved by Agency Representative before charts are prepared.
2. Provide one controller chart for each automatic controller. Chart shall show the area covered by controller.
3. The chart is to be a reduced copy of the actual "record" drawing. In the event the controller sequence is not legible when the drawing is reduced, it shall be enlarged to a readable size.
4. Chart shall be a blackline print with a different color used to show the area of coverage for each station.
5. When completed and approved, the chart shall be hermetically sealed between two pieces of plastic, each piece being a minimum 20 mils in thickness.

B. Operation and Maintenance Manuals:

1. Two individually bound copies of operation and maintenance manuals shall be delivered to the Agency Representative 10 calendar days prior to final inspection. The manuals shall describe the material installed.
2. Each complete, bound manual shall include the following information:
 - a. Index sheet stating Contractor's address and telephone number, duration of guarantee period, list of equipment including names and addresses of local manufacturer representatives.
 - b. Complete operating and maintenance instructions for all equipment.
 - c. Spare parts lists and related manufacturer information for all equipment.

C. Equipment:

1. Supply as part of this contract the following items:
 - a. 4 additional sprinkler heads of each type and spray pattern shown.
 - b. Two (2) wrenches for disassembly and adjustment of each type of sprinkler head involved.
 - c. The above equipment shall be turned over to the Engineer at the final inspection.

1.05 GUARANTEE:

- A. General: The entire sprinkler system, including all work done under this contract, shall be guaranteed against all defects and fault of material and workmanship for a period of one (1) year following the filing of the Notice of Completion. All materials used shall carry a manufacturer's guarantee of one (1) year.

Should any problem with the irrigation system be discovered within the guarantee period, it shall be corrected by the Contractor at no additional expense to the Agency

within ten (10) calendar days of receipt of written notice from the Agency Representative. When the nature of the repairs as determined by the Agency Representative constitute an emergency (e.g. broken pressure line) the Agency may proceed to make repairs at the Contractor's expense. Any and all damages to existing improvement resulting either from faulty materials or workmanship, or from the necessary repairs to correct same, shall be repaired to the satisfaction of the Agency Representative by the Contractor, all at no additional cost to the Agency.

- B. Form of Guarantee: Guarantee shall be submitted on Contractors own letterhead as follows:

FORM OF:
GUARANTEE FOR SPRINKLER IRRIGATION SYSTEM

We hereby guarantee that the sprinkler irrigation system we have furnished and installed is free from defects in materials and workmanship, and the work has been completed in accordance with the drawings and specifications, ordinary wear and tear and unusual abuse, or neglect excepted. We agree to repair or replace any defects in materials or workmanship which may develop during the period of one year from date of filing of the Notice of Completion and also to repair or replace any damage resulting from the repairing or replacing of such defects at no additional cost to the Agency. We shall make such repairs or replacements within 10 calendar days following written notification by the Agency. In the event of our failure to make such repairs or replacements within the time specified after receipt of written notice from the Agency Representative, we authorize the Agency to proceed to have said repairs or replacements made at our expense and we will pay the costs and charges therefore upon demand.

PROJECT: _____

LOCATION: _____

SIGNED: _____

ADDRESS: _____

PHONE: _____

- C. After the system has been completed, the Contractor shall instruct the Agency Representative in the operation and maintenance of the system and shall furnish a complete set of operating instructions.
- D. Any settling of trenches which may occur during the one-year period following acceptance shall be repaired to Agency Representative satisfaction by the Contractor without any additional expense to the Agency. Repairs shall include the complete restoration of all damage to planting, paving or other improvements of any kind as a result of the work.

PART II - MATERIALS

2.01 GENERAL:

Materials or equipment installed or furnished that do not meet the Agency standards will be rejected and shall be removed from the site at no expense to the Agency.

2.02 PIPE:

- A. Non-pressure lines shall be Schedule 40.
- B. Pressure pipe shall be Class 200.

2.03 PLASTIC PIPE AND FITTINGS:

- A. All plastic pipe shall bear the following markings: manufacturer's name, nominal pipe size, schedule or class, type of material, pressure rating in psi, NSF seal of approval, and the date of extrusion. All plastic pipe shall be extruded of an improved PVC virgin pipe compound.
- B. All plastic pipe shall be extruded of an improved PVC virgin pipe compound.
- C. Rubber gasket PVC pipe, couplings, and fittings shall conform to ASTM D 1784 Type I, Grade I, 2,000-psi design stress. Couplings, rubber gaskets, and fittings shall be as approved by the pipe manufacturer.
- D. Ring-type rubber gasket couplings shall permit a 5 degree deflection of the pipe at each coupling (2-1/2 degree each side) without exfiltration or infiltration, cracking or breaking.
- E. All fittings shall be standard weight Schedule 40 and shall be injection molded of an improved PVC fitting compound. Threaded plastic fittings shall be injection molded. All tees and ells shall be side gated. All threaded nipples shall be standard weight Schedule 80 with molded threads.
- F. All solvent cementing of plastic pipe and fittings shall be a two-step process, using primer and solvent cement applied per the manufacturer's recommendations. Cement shall be of a fluid consistency, not gel-like or ropy.

2.07 VALVES:

- A. Remote Control Valves:

Valves shall be spring-loaded, self-cleaning, packless diaphragm activated, of a normally closed type.

2.08 VALVE BOXES:

- A. Valve boxes shall be fabricated from a durable, weather-resistant plastic material resistant to sunlight and chemical action of soils.
- B. The valve box cover shall be secured with a hidden latch mechanism or bolts.
- C. The cover and box shall be capable of sustaining a minimum load of 1,500 pounds.
- D. Valve box extensions shall be by the same manufacturer as the valve box.
- E. Remote control valve boxes shall be rectangular plastic boxes with bolt-down covers marked "CONTROL VALVE"; and with the valve identification number heat branded in 2" high characters; NDS Pro-Plus or approved equal.
- F. Colors of boxes shall be as called for on the plans.

2.09 ELECTRICAL:

- A. All electrical equipment shall be NEMA Type 3 or 4, waterproofed for exterior installation.
- B. All electrical work shall conform to local codes and ordinances.

2.10 WIRING:

- A. Remote control wire shall be direct-burial AWG-UF type, sized according to manufacturer's specifications, and in no case smaller than 12 gage.
- B. Connections shall be epoxy-sealed packet-type connectors.
- C. Common wires shall be white in color. (Where two or more controllers are used, the common wires shall be white with a different color stripe for each controller.) Control wires shall be black (where two or more controllers are used, the control wires shall be a different color for each controller.) These colors shall be noted on as-built plans located on controller door.

2.11 SPRINKLERS:

Sprinklers shall be as called for on the plans.

PART III - EXECUTION

3.01 GENERAL:

A. Layout:

Layout irrigation systems and make minor adjustments required due to differences between site and drawings. Where piping is shown on drawings under paved areas, but running parallel and adjacent to planted areas, install the piping in the planted areas.

B. Diagrammatic Intent:

The drawings are essentially diagrammatic. The size and location of equipment and fixtures are drawn to scale where possible. Provide offsets in piping and changes in equipment locations as necessary to conform with structures and to avoid obstructions or conflicts with other work.

C. Grades:

Before starting work, carefully check all grades to determine that work may safely proceed, keeping within the specified material depths with respect to finish grade.

D. Inspections:

1. Prior to all work of this section, carefully inspect the installed work of all other trades and verify that all such work is complete to the point where this installation may properly commence.
2. Verify that irrigation system may be installed in strict accordance with all pertinent codes and regulations, the original design, the referenced standards, and the manufacturer's recommendations.

E. Discrepancies:

1. In the event of discrepancy, notify the Agency Representative and the Landscape Architect.
2. Do not proceed with installation in areas of discrepancy until all discrepancies have been resolved.

F. Field Measurements:

Make all necessary measurements in the field to ensure precise fit of items in accordance with the original design. Contractor shall coordinate the installation of all irrigation materials with all other work.

3.02 TRENCHING:

- A. Dig trenches and support pipe continuously on bottom of ditch. Lay pipe to an even grade. Trenching excavation shall follow layout indicated on drawings to the depths below finished grade and as noted. Where lines occur under paved area, these dimensions shall be considered below subgrade.
- B. Provide minimum cover of 24 inches, maximum 36 inches for control wires.
- C. Provide minimum cover of 12 inches, maximum 16 inches for non-pressure lines.
- D. Provide minimum cover of 24 inches, maximum 30 inches for all pipe sleeved under paving.

- E. Where it is necessary to excavate adjacent to existing trees, the Contractor shall avoid injury to trees and tree roots. Excavation in areas where 2-inch and larger roots occur shall be done by hand. All roots 2 inches and larger in diameter shall be tunneled under and shall be heavily wrapped with wet burlap to prevent scarring or drying. Where trenching machine is run close to trees having roots smaller than 2 inches in diameter, the wall of the trench adjacent to the tree shall be hand trimmed, making a clean cut through the roots. Roots 1 inch and larger in diameter shall be painted with two coats of Tree Seal or approved equal. Trenches adjacent to trees shall be closed within 24 hours.

3.03 BACKFILLING:

- A. Initial backfill on all lines shall be of fine granular material with no foreign matter larger than 2 inch in size.
- B. Backfill shall be tamped in 4-inch layers under the pipe and uniformly on both sides for the full width of the trench and the full length of the pipe. Materials shall be sufficiently damp to permit thorough compaction, free of voids. Backfill shall be compacted to dry density equal to adjacent undisturbed soil and shall conform to adjacent grades.
- C. Flooding in lieu of tamping is not allowed without specific prior approval.
- D. Under no circumstances shall truck or tractor wheels be used to compact soil.
- E. Provide sand backfill a minimum of 6 inches over and under all piping under paved areas.

3.04 PIPING:

- A. Piping under existing pavement may be installed by jacking, boring, or hydraulic driving. No hydraulic driving is permitted under asphaltic concrete pavement.
- B. Cutting or breaking of existing pavement is not permitted.
- C. Carefully inspect all pipe and fittings before installation, removing dirt, scale, and burrs and reaming; install pipe with all markings up for visual inspection and verification.
- D. Exercise care in handling, loading, unloading, and storing plastic pipe and fittings; store plastic pipe and fittings under cover until ready to install; transport plastic pipe on a vehicle with a bed long enough to allow the pipe to lay flat, avoid undue bending and any concentrated external load.
- E. Remove all dented and damaged pipe sections.

- F. All lines shall have a minimum clearance of 6 inches from each other and 12 inches from lines of other trades.
- G. Parallel lines shall not be installed directly over one another.
- H. In solvent welding, use only the specified primer and solvent cement and make all joints in strict accordance with the manufacturer's recommended methods; allow solvent welds at least 15 minutes setup time before moving or handling and 24 hours curing time before filling.
- I. 360 degree applicators shall be used to apply primer and solvent on sizes 2 inches and larger.
- J. Centerload all plastic pipe prior to pressure testing.
- K. All threaded plastic-to-plastic connections shall be assembled using Teflon tape.
- L. For plastic-to-metal connections, work the metal connections first. Use a non-hardening pipe dope on all threaded plastic-to-metal connections, except where noted otherwise.

3.05 ASSEMBLIES:

- A. Install all assemblies specified herein according to the respective detail drawings or specifications, using best standard practice.
- B. Valves shall be installed in shrub areas whenever possible per Agency standards.
- C. Each valve box shall be installed on a foundation of pea gravel backfill, 3 cubic feet minimum. Valve boxes shall be installed with their tops 1 inch above the surface of surrounding finish grade in lawn areas.

3.06 WIRING:

- A. Wiring shall occupy the same trench and shall be installed along the same route as the pressure supply lines and shall be located below the supply lines wherever possible.
- B. Where more than one wire is placed in a trench, the wiring shall be taped together at intervals of 8' feet.
- C. All connections shall be of an approved type and shall occur in a valve box. Provide an 18-inch service loop at each connection.
- D. An expansion loop of 12 inches shall be provided at each wire connection and/or directional turn, and one of 24 inches shall be provided at each remote control valve.

- E. A continuous run of wire shall be used between a controller and each remote control valve. Under no circumstances shall splices be used without prior approval.

3.07 FLUSHING THE SYSTEM:

- A. Prior to installation of sprinkler heads, the valves shall be opened and a full head of water used to flush out the lines and risers.
- B. Sprinkler heads shall be installed after flushing the system has been completed.

3.08 SPRINKLER HEADS:

- A. Sprinkler heads shall be installed as designated on the drawings and per Agency standards.
- B. Spacing of heads shall not exceed maximum indicated on the drawings.

3.09 ADJUSTING THE SYSTEM:

- A. Contractor shall adjust valves, align heads, and check coverage of each system prior to coverage test.
- B. If it is determined by the Agency Representative that additional adjustments or nozzle changes will be required to provide proper coverage, all necessary changes or adjustments shall be made prior to any planting.
- C. The entire system shall be operating properly before any planting operations commence.

3.10 COMPLETION CLEANING:

Upon completion of the work, Contractor shall smooth all ground surfaces; remove excess materials, rubbish, debris, etc.; sweep adjacent streets, curbs, gutters, walkways, and trails; and remove construction equipment from the premises.

END OF SECTION

SECTION 02445 - TEMPORARY CHAINLINK FENCING1.01 TEMPORARY FENCING:

Install a 6' tall (min.) temporary construction fence panels, prior to beginning any site work at the perimeter of active work. The fence shall be chain link (new or used), free of openings or breaks in the fabric, with fence posts at 10' O/C maximum. Fencing shall incorporate green "tennis court" windscreen material, securely fastened to top and bottom of chain link fabric, for the entire secured perimeter of the fence line. The fence shall be maintained in place throughout the construction phase period through to the end of the ninety (90) day landscape maintenance period. Install ■No Trespassing• signs minimum 150' o.c., with wording presented in both English and Spanish. The temporary fence shall be removed prior to final inspection/project acceptance at the end of the maintenance period.

END OF SECTION

SECTION 02470 - SITE FURNISHINGS**PART 1 - GENERAL****1.01 RELATED DOCUMENTS:**

The provisions of the "Standard Specifications for Public Works Construction" shall also apply to this section.

1.02 SCOPE OF WORK:

The work included in this section generally consists of providing all labor, equipment and materials necessary to install all site furnishings complete as shown on the plans and as described herein.

1.03 SUBMITTALS:

- A. Contractor shall submit a written work schedule and cost breakdown for the various elements of the work at the preconstruction conference. Contractor shall also submit a complete list of materials along with manufacturers catalog data for all materials proposed for use in the work as a substitute for those specified herein.
- B. Manufacturer's Product Data: Submit six (6) copies of manufacturer's literature for each item of site furnishings.
- C. Submit suppliers certificates attesting that the materials furnished will meet specifications.

1.04 DELIVERY, STORAGE AND HANDLING:

Contractor assumes all responsibility for storage of all materials relative to this project. Agency assumes no liability for losses or damages from any cause as a result of such storage.

1.05 JOB CONDITIONS - PROTECTION:

After slabs are poured and site furnishings are installed, all damage to surrounding irrigation system shall be repaired by the contractor at the contractor's expense. All trees and shrubs in and around the project site shall be protected by the contractor and, if damaged, replaced at the contractor's expense. This provision is in effect until acceptance by owner of the complete project.

1.06 LOCATION INSPECTION:

No equipment, apparatus or foundations for same shall be placed until location stakes have been inspected and accepted by the Projects Inspector.

1.07 GUARANTEE & LIABILITY INSURANCES:

A. Manufacturer shall guarantee all materials and workmanship for a period of one (1) year, exclusive of vandalism. Manufacturer will be required to provide product liability insurance coverage in the minimum amounts of \$1,000,000.00 per incident.

The manufacturer will be required to provide complete installation drawings including specifications and a replacement parts list for all products.

B. Contractor shall provide a written guarantee on his firm's letterhead for all materials and workmanship for a period of one (1) year exclusive of vandalism. Written guarantee shall be submitted to the Agency at the final inspection prior to final acceptance of the work.

PART 2 - PRODUCTS

2.01 SHADE STRUCTURE:

Shall be 24' hexagon with standing seam, 'Copper Penny' roof and square K01 columns. Frame color to be 'Bumper Black.' Available from Poligon (888)888-2060.

2.02 TRASH RECEPTACLES:

Shall be 2-compartment concrete trash/recycling receptacle, model #511, color to be Davis 'Sequoia Sand'. Available from Outdoor Creations Inc. (530)365-6106.

2.03 PICNIC TABLES:

Shall be concrete model #100SK and #100SK2E with side wheelchair accessibility. Color to be Davis 'Sequoia Sand'. Available from Outdoor Creations Inc. (530)365-6106.

2.04 CHARCOAL GRILL:

Shall be concrete family barbecue #300A. Color to be Davis 'Sequoia Sand'. Available from Outdoor Creations Inc. (530)365-6106.

PART 3 - EXECUTION

3.01 LAYOUT:

Contractor shall stake/mark locations for all slabs and foundations and shall obtain the approval of their location from Agency Representative prior to commencing any digging. Locations shall be adjusted to provide minimum clear distances required from all edges of slabs, trees, irrigation heads, or other obstructions.

3.02 FURNITURE INSTALLATION:

- A. All site furnishings shall be installed with vandal-proof hardware or made vandal-proof (deforming or peening), or Simpson SET-22 epoxy complying to ICC-ES ESR-1772.
- B. Block outs for "after slab installation" will not be allowed.

3.03 CLEAN-UP:

Contractor shall clean up and legally dispose of all unused materials, excess soil, and debris at regular intervals throughout the duration of the work, and as directed by the Agency Representative.

3.04 PROTECTION OF EXISTING IMPROVEMENTS:

Contractor shall protect all existing improvements from damage.

END OF SECTION

SECTION 02480 - PLANTING**PART 1 - GENERAL****1.01 SCOPE:**

The work required is indicated on the drawings and includes, but is not necessarily limited to: soil preparation; finish grading; planting shrubs and ground cover; soil erosion control; maintenance; plant establishment period; guarantees; and replacement.

1.02 GUARANTEE:

- A. During the guarantee period, any material found to be dead, missing, or in poor condition shall be replaced by the Contractor within ten (10) days of written notification. The Agency Representative shall be the sole judge as to the condition of the material.
- B. Replacement shall be made in accordance with these specifications and the plans.
- C. Material and labor involved in replacing plant material shall be provided by the Contractor at no additional cost to the Agency.

1.03 INSPECTIONS:

Inspections will be required. The Contractor shall contact the Agency Representative at least 2 working days in advance of an anticipated inspection. Failure to schedule inspection will result in penalty, per the City Fee Schedule. An inspection will be required at each of the steps listed below:

- A. Upon completion of fine grading, and prior to commencement of soil preparation, for acceptance of fine grading work and taking of soils samples.
- B. Inspection of completed finish grading work per this section following soil amendment work.
- C. When planting and all other indicated or specified work has been completed.
- D. During application of pre-emergent chemical.
- E. At start of plant establishment and maintenance period.
- F. At the end of the plant establishment period, concurrent with final acceptance of the project for maintenance by the City Parks & Community Services Department. This acceptance for maintenance will be confirmed in writing by the Landscape Architect.

1.04 SOILS TEST:

Contractor shall notify Landscape Architect upon completion of fine grading and prior to commencement of soil preparation work. The Contractor will obtain agronomic soils tests for all planting areas after completion of fine grading and prior to start of soil preparation work. Tests will be performed by Agency approved agronomic soils testing laboratory and will include a fertility and suitability analysis with written recommendations for soil preparation, planting backfill mix, auger hole requirements, and post plant fertilization program. The soils report recommendations shall take precedence over the minimum amendment and shall be approved by the Landscape Architect PRIOR to planting in writing, and fertilizer application rates specified herein only when they exceed the specified minimums. A copy of the soils report shall be submitted to the Agency Representative for approval.

1.05 SUBMITTALS:

- A. The following written certifications are required to be submitted to the Landscape Architect upon delivery of the respective materials to the job site:
 - Total Quantity of commercial fertilizers by type
 - Total Quantity of soil amendments and conditioners by type
 - Total Quantity of mulch
 - Total Quantity of iron sulphate
- B. All bagged products shall stay on the site in a neat and orderly manner until the final approval by the Landscape Architect.

PART II - MATERIALS

2.01 FERTILIZER, SOIL AMENDMENTS AND CONDITIONERS:

- A. Planting Tablets: Tightly compressed long-lasting, 12 month slow-release fertilizer tablets weighing 7 grams, and having an analysis of 12-8-8 derived from the sources listed in the following guaranteed analysis:

GUARANTEED ANALYSIS:

| | |
|--|------|
| Total Nitrogen(N) | 12% |
| Derived from urea formaldehyde | |
| 7.0% water soluble nitrogen | |
| 13.0% water insoluble nitrogen | |
| Available Phosphoric Acid (P ₂ O ₅) | 8% |
| Derived from triple super phosphate | |
| Soluble Potash (K ₂ O) | 8% |
| Combined Sulfur (S) | 3.5% |
| Derived from ferrous and potassium sulfate | |

Iron (expressed as elemental Fe) 2.0%
Derived from ferrous sulfate

B. Commercial fertilizer shall bear the manufacturer's guaranteed statement of analysis and shall meet the following minimum requirements: 14% nitrogen, 7% phosphoric acid, 7% potash with 30% humus and 6% humic acids.

C. Organic Soil Amendment:

Shall be nitrogen fortified redwood, cedar, or fir sawdust and shall contain minimum 1% available nitrogen. Material containing manure, pine, or other material will not be accepted.

D. Mulch:

Shall be nitrogen fortified redwood, cedar or fir shavings and shall contain minimum 1% available nitrogen.

E. Soil Conditioner/Fertilizer:

Shall be composted higher plant form life below the fibrous stage to support bacterial culture analysis: 5% nitrogen, 3% phosphorus, 1% potash, 50% humus, 15% humic acid, with bacteria included and 1% soil penetrant. (Gro-Power Plus) Available through Gro-Power, Inc. (800) 473-1307.

F. Soil Conditioners:

Inorganic conditioners shall be agricultural grade gypsum, soil sulfur and iron sulfate. Iron sulfate shall be ferric sulfate or ferrous sulfate in pelleted or granular form containing not less than 18.5% iron, expressed as metallic iron, and shall be registered as an agricultural mineral with the State Department of Agriculture in compliance with Article 2 "Fertilizing Materials", Section 1030 of the Agriculture Code.

2.02 PLANTS:

A. All plants shall be true to name, and 100% of plants shall be tagged with the variety and size of plants in accordance with the standards of practice recommended by the American Association of Nurserymen. The root condition of plants furnished in containers shall be determined by removal of earth from the roots of not less than two plants nor more than 2% of the total number of plants of each species or variety except when container-grown plants are from several different sources: in which case, the roots of not less than two plants of each species or variety from each source shall be checked by the Agency Representative at his option. The selection of plants to be checked will be made by the Agency Representative. All plants rendered unsuitable for planting shall be considered as samples, and replacements shall be provided at no additional cost. In case the sample plants are found to be defective, the entire lot or lots of

plants represented by the defective samples will be rejected.

- B. All trees and shrubs supplied by Contractor shall be of the specified standard height and diameter set by the American Standard for Nursery Stock. The height of the trees shall be measured from the root crown to the last division of the terminal leader and the diameter shall be measured six (6) inches above the crown roots. Trees and shrubs shall stand erect without support.
- C. Flatted Plants: Ground cover plants and other flatted plants shall be grown and remain in the flats until transplanted at the site. The soil and spacing of the plants in the flat shall ensure the minimum disturbance of the root system at transplanting.

2.03 BACKFILL MATERIAL:

- A. Topsoil shall be free from noxious weed seed and shall be of a loam characteristic, fertile and friable.
- B. Wood shavings shall be leached nitrogen fortified and shall be free of foreign matter.
- C. Soil used for backfill of planting pits shall be enriched using the following blend per cubic yard (agronomic soil test recommendations to be reviewed prior to soil mixing) and have written approval by Landscape Architect before planting.

60% site soil or approved import
 40% wood shavings
 17 lbs. soil condition/fertilizer (Gro-Power Plus)
 1 lb. iron sulfate

All plant pits shall be backfilled with backfill mix as specified above.

- D. All soil backfill shall be bulk mixed, not individually mixed at each plant pit.

2.04 HERBICIDE ERADICATION:

Contact/Translocative: Roundup, or approved equal.
 Pre-emergent: Dimension 2.5G

PART III - EXECUTION

3.01 LANDSCAPE GRADING:

The Contractor shall complete preliminary grading filling as needed or removing surplus dirt, removing rocks and debris over 1 inch in diameter within the top 2" of soil in flat and slope areas, and removing rocks over 2" in diameter within the top 6" of soil in areas with slopes less than 3:1. Bring all areas to be landscaped to finish grade. All areas shall slope to drain. Flow lines shall be established to existing road curbs and/or sidewalks as shown on the plans and as directed.

3.02 WEED CONTROL MEASURES:

- A. Upon completion of all fine grading work and prior to soil preparation, perform weed control measures as follows:
 1. Irrigate all areas designated to be planted for a minimum of 10 minutes per setting, two settings per day for seven days to germinate all weed seed possible.
 2. Apply a contact weed killer and allow sufficient time to obtain complete kill of all weeds germinated.
 3. Repeat step one above.
 4. Immediately after planting, install pre-emergent per manufacturer recommendation.

3.03 SOIL PREPARATION:

- A. All fine grading and mounding and all weed control measures shall be completed prior to soil preparation.
- B. This work shall not commence until the agronomic soils test has been completed. Should 30 calendar days elapse between completion of soil preparation and commencement of planting, all areas shall be prepared again.
- C. In planting areas with gradients less than 3:1, a layer of soil amendments shall be spread and rototilled into the soil to a minimum depth of 4 inches, or as recommended by the soils report, so that the soils shall be loose, friable, and free from all rocks, sticks, and other objects undesirable to planting.
- D. The following soil amendments shall be added per 1,000 square feet to all planting areas with gradients less than 3:1 (agronomic soil test recommendations shall take precedence where these minimum amounts are exceeded) and need written approval by the Landscape Architect before planting.
 - 1. 3 cubic yards organic amendment.
 - 2. 200 pounds soil conditioner/fertilizer (Gro-Power Plus)

All landscape areas shall be finish graded to "dress out", maintain, and/or reestablish grades and flow lines as approved prior to amending the soil. Finish grades will be inspected upon completion. Contractor shall not proceed with planting work until finish grades have been inspected and accepted by the Landscape Architect.

3.04 FINISH GRADING:

After completion of all soil preparation work the Contractor shall finish grade all planting areas filling as needed or removing surplus dirt, removing rocks and debris over 1 inch in diameter, and floating to a smooth uniform grade. All areas shall slope to drain. Flow lines shall be established to existing road curbs and/or a sidewalk as shown on the plans and as directed.

3.05 PLANTING:

- A. All plant holes shall be filled to the brim with water and allowed to drain before any planting is done. If water does not drain out of hole within 24 hours, this fact must be brought to the attention of the Agency Representative and the Landscape Architect, so that corrections can be made. Correctional work shall be considered as an extra, at additional expense.
- B. Soil surrounding planting pit shall be in a friable condition and moist to a depth of 8".
- C. Backfill using specified soil mix to within 8" of finish grade. At this depth, place the plant fertilizer tablets Gro-Power planting tablets, 12-8-8, 7 grams each or equal. A minimum of 3 tablets for 1 gallon; 8 tablets for 5 gallons; 15 tablets for 15 gallons, and 22 tablets for a 24" box. Complete backfilling to finish grade.

3.06 GROUND COVER AND VINE PLANTING:

Soil preparation and fine grading shall be completed prior to ground cover planting.

Mulch and fertilize ground cover areas per Section 3.02, part D. of planting specifications.

All rooted ground cover and bare dirt areas are to be treated with a pre-emergent chemical (subject to approval by the Landscape Architect prior to application). Chemicals are to be applied by a licensed Pest Control Agent. This treatment shall be applied at the following times during the contract: a) before planting, b) at beginning of plant establishment period, and c) at the end of plant establishment period. The Agency Representative shall be given a minimum of 48 hours (2 working days) notice prior to each application. No chemicals shall be applied other than in the presence of the inspector.

Ground cover shall be planted below all shrubs and trees to within 12" of the shrub main stem unless otherwise noted on the plans.

Ground cover and vines shall be planted in moist soil and spaced as indicated on the plans.

Each plant shall be planted with its proportionate amount of flat soil to minimize root disturbance. Soil moisture shall be such that the soil does not crumble when removing plants.

Following planting, ground cover and vine areas shall be re-graded to restore smooth finish grade and to ensure proper surface drainage. A 2-inch (50 mm) layer of Type 1 mulch shall be spread over the planted areas. Watering shall begin immediately following mulching.

When necessary to prevent plant damage from pedestrian traffic during the initial growing stage, the Contractor shall erect temporary protective fencing to be removed at the end of the plant establishment period.

Vines shall be tied to walls, fences, etc., in the manner prescribed on the plans. Temporary staking shall be removed at the beginning of the plant establishment period.

3.07 WATERING:

- A. It shall be the Contractor's responsibility to maintain a balanced watering program to ensure proper growth until final acceptance of the work.
- B. Immediately after planting, apply water to each tree, shrub or vine. Apply water in a moderate stream in the planting hole until the material about the roots is completely saturated from the bottom of the hole to the top of the ground.
- C. Apply water in sufficient quantities and as often as seasonal conditions require to keep the planted areas moist at all times, well below the root system of plants.
- D. Irrigation:

1. Contractor shall properly and completely maintain the irrigation system. A balanced water program shall be maintained to ensure proper growth until final acceptance of the work. Plants which cannot be watered efficiently with the irrigation system shall be watered by means of a hose.
2. All controllers are to have each station individually adjusted on a weekly basis. System shall be set considering the application rate each area is capable of receiving. The system shall operate on short intervals, with the cycle repeating at a later time to reduce runoff.

3.08 MAINTENANCE:

- A. All areas landscaped by Contractor under this contract shall be maintained by him for a minimum plant establishment period of not less than ninety (90) days from the date of written acceptance for start of the plant establishment period.
- B. Contractor shall maintain existing planted areas which are within the work limits of the contract as shown on the plans. This maintenance shall continue for the duration of the construction period. The contractor shall provide and allow access by Agency maintenance people into or through work limit areas for the purpose of normal maintenance of existing park areas remaining outside of the work limit areas.

3.09 START OF PLANT ESTABLISHMENT:

- A. Criteria for start of plant establishment period:
 1. The plant establishment period shall not start until all elements of the project that impact the landscape are completed in accordance with the contract documents. Projects will not be segmented into phases.
 2. Permanent Power to remote controllers shall be established.
 3. The plant establishment period for the project shall not begin until after the first mowing of all of the newly planted turf areas. New turf shall not be mowed until attaining a minimum height of 1-1/2 inches. Turf shall be maintained at a mowing height of 2 inches. Turf shall be rotary mowed minimum weekly.
 4. Written acceptance of the Agency Representative must be obtained to the start of the plant establishment period.
 5. If the project maintenance fails to continuously meet standards required, the plant establishment period "day count" will be suspended and will not recommence until Contractor has corrected all deficiencies.

3.10 MAINTENANCE TASKS:

A. General:

During the contract period provide all watering, weeding, fertilizing and cultivation, and spraying necessary to keep the plants and turf in a healthy growing condition and to keep the planted areas neat, edged, and attractive. All trees and shrubs planted under the contract shall be pinched and pruned as

necessary to encourage new growth and to eliminate sucker growth. Old wilted flowers and dead foliage shall be immediately pinched or cut off. Do no tree pruning without the written approval of the Agency Representative or the Landscape Architect.

B. Iron Chlorosis:

After planting and during the plant establishment period in the event that trees exhibit iron chlorosis symptoms, apply FE 138 Geigy or equivalent at manufacturer's recommended rates.

C. Replacement Plantings:

During the plant establishment period, should the appearance of any plant indicate weakness, that plant shall be replaced immediately with a new, healthy plant. At the end of the plant establishment period, all plant materials shall be in a healthy, growing condition and spaced as indicated on the plans.

D. Fertilization:

The Contractor shall begin fertilizing all turf areas four weeks after first mowing at a rate of 7 1/4 pounds per 1000 square feet of commercial fertilizer 14-4-9.

The Contractor shall apply the second and all following applications of commercial fertilizer to all turf areas at a rate of 5 pounds per 1000 square feet, and all ground cover areas at a rate of 5 pounds per 1000 square feet, at 30-day intervals, for 3 applications as a minimum, above and beyond the original soil preparation application.

E. Planting Establishment:

Any planting areas that do not show a prompt establishment of plant material shall be replanted at 10-day intervals until the plant material is established. If a good rate of growth has not been demonstrated within 30 days of first planting/hydroseeding, the Contractor shall be responsible to determine the appropriate horticultural practices necessary to obtain good growth. The Contractor shall obtain agronomic soils testing of all areas not showing good growth and shall provide copies of the test results to the Agency Representative to verify the appropriateness of all maintenance work performed. If additional soil amendments are needed, up to a maximum 25% beyond the amount specified, such amendments shall be provided by the Contractor at no additional cost to the Agency.

F. Grading and Drainage:

During the plant establishment period all flow lines shall be maintained to allow for free flow of surface water. Displaced material which interferes with drainage shall be removed and placed as directed. Low spots and pockets shall be graded to drain properly. Jute netting shall be installed at flow lines and other locations where erosion is evident, when directed by the inspector.

1. Damage to planting areas shall be repaired immediately and throughout the plant establishment period. Depressions caused by vehicles,

bicycles, or foot traffic shall be filled and leveled. Replant damaged areas.

2. All paved areas shall be washed and maintained in a neat and clean condition at all times.
3. Debris and trash shall be removed from the site weekly at a minimum.
4. All subsurface drains shall be periodically flushed with clear water to avoid buildup of silt and debris. Keep all drain inlets clear of leaves, trash, and other debris.

G. Disease and Pest Control:

Throughout the plant establishment period, all plants shall be maintained in a disease and pest free condition. A licensed pest control operator shall be retained by the Contractor to recommend and apply all pesticides, herbicides, and fungicides. Exterminate gophers, moles, and all other rodents, and repair damage.

H. Trash:

Debris and trash shall be removed from the site weekly at a minimum.

3.11 END OF PLANT ESTABLISHMENT PERIOD:

- (1) When the Contractor believes he has completed the plant establishment period and the entire project is ready for final acceptance, he shall request inspection of the project. The Agency Representative and the Landscape Architect will inspect the project for final acceptance. Deficiencies noted during inspection shall extend the plant establishment period until all are corrected.
- (2) All planting areas shall show a good rate of growth and shall be well established "filled in" plantings free of voids. Bare areas will be unacceptable. Contractor shall provide sod or planting from flats as necessary to fill in all bare areas. Such sod or plantings shall be planted a minimum of 10 days prior to the end of the plant establishment period and shall have roots "knit-in" to the native soil.
- (3) Final acceptance shall occur only upon written acceptance of the project for maintenance by the Agency Representative.

3.12 CLEAN UP:

Upon completion of the work, the Contractor shall smooth all ground surfaces; remove excess materials, rubbish, debris, etc.; sweep adjacent streets, curbs, gutters, walkways, and trails; and remove construction equipment from the premises.

END OF SECTION

DIVISION 3

SECTION 03010 - CONCRETE

PART I - GENERAL

1.01 QUALITY ASSURANCE:

- A. Codes and Standards: Comply with the provisions of the following codes, specifications and standards, except where more stringent requirements are shown or specified:
1. ACI 301 "Specifications for Structural Concrete for Building."
 2. ACI 318 "Building Code Requirements for Reinforced Concrete."
 3. ACI 347 "Recommended Practice for Concrete Formwork."
 4. ACI 304 "Recommended Practice for Measuring, Mixing, Transporting and Placing Concrete."
 5. Concrete Reinforcing Steel Institute, "Manual of Standard Practice."
 6. California Building Code (CBC), 2013 Edition.
- B. Testing: Owner's testing laboratory will perform sampling and testing during concrete placement, which may include the following, as directed by the Architect. Comply with LABC Section 91.2604.3.
1. Sampling: ASTM C 172.
 2. Slump: ASTM C 173, one test for each load at point of discharge.
 3. Air Content: ASTM C 173, one for each set of compressive strength specimens.
 4. Compressive Strength: ASTM C 39, one set for each 50 cu. yds. of each grade of structural concrete; and at least one test for each day's concreting for each grade of concrete used, two specimens tested at 28 days.

1.02 SUBMITTALS:

- A. Comply with pertinent provisions of Section 01300.
- B. For all concrete, a signed copy of batch plant's certificate stating the quantity of each material, amount of water, admixtures, departure time and date shall accompany each load of materials or concrete.
- C. Submit test results as required by Agency.
- D. Product Data: Submit manufacturer's product data with installation instructions for proprietary materials including reinforcement and forming accessories,

admixture, joint materials, hardeners, curing materials and others as requested by the Architect.

- E. Laboratory Reports: Submit laboratory test or evaluation reports for concrete materials and mix designs as required by Agency.

PART II - PRODUCTS

2.01 FORM MATERIALS:

- A. Forms for Exposed Finish Concrete: Unless otherwise indicated, construct formwork for exposed concrete surfaces with plywood or other acceptable panel-type materials, to provide continuous, straight, smooth, exposed surfaces. Furnish in largest practicable sizes to minimize number of joints and to conform to joint system shown on drawings. Provide form materials with sufficient thickness to withstand pressure of newly-placed concrete without bow or deflection.
- B. Forms for Unexposed Finish Concrete: Form concrete surfaces which will be unexposed in finished structure with plywood, lumber, metal or other acceptable material. Provide lumber dressed on at least two edges and one side for tight fit.

2.02 CONCRETE MATERIALS:

- A. Portland Cement: ASTM C 150, type I or type II.
- B. Aggregates: ASTM C 33, except local aggregates of proven durability may be used when acceptable to Architect. Provide aggregates from a single source for exposed concrete.
- C. Water: Potable.

2.03 CONCRETE ADMIXTURES:

- A. General: Provide admixtures produced by established reputable manufacturers and use in compliance with the manufacturer's printed directions. Do not use admixtures which have not been incorporated and tested in accepted mixes, unless otherwise authorized in writing by the Agency Representative.
- B. The following admixtures may be used with written approval of Structural Engineer. Conform to manufacturer's recommendations for use.
1. Water Reducing: ASTM C 494. Shall provide a minimum of 5% water reduction, 10% increase of 28 day compressive strength, drying shrinkage at 21 days shall be less than concrete without admixture.
 2. Acceleration or Retarding: ASTM C 494.
- C. Waterproofing Admixture: SIKA CHEMICAL CORPORATION "Sika Red Label" (Sikamix 198).
- D. Calcium chloride not permitted.

2.04 JOINT MATERIALS:

- A. Keyed Metal Joint: BURKE CONCRETE ACCESSORIES "Keyed Kold" 24 gauge galvanized steel joint form with steel "Keyed Kold" stakes.
- B. Fiber Joint Filler: ASTM D 1751 non-extruding premolded bituminous impregnated fiberboard units. Plain or punched for dowels as required.
- C. Plastic Joint Insert: "Quickjoint" T-shaped 1/16" plastic strip, 1 inch minimum depth as distributed by J.A. CRAWFORD CO., phone (213) 698-0901.

2.05 VAPOR BARRIER:

- A. Provide vapor barrier cover over prepared base material where shown on drawings. Use only materials which are resistant to decay when tested in accordance with ASTM D 154, as follows:
 - 1. Provide polyethylene sheet not less than 10 mils thick.

2.06 FINISH MATERIALS:

- A. Sealer: A.C. HORN "Horntraz."

2.07 CURING MATERIALS:

- A. Liquid Curing Compound: ASTM C 309, type 1 non-staining, approved standard product resin type.
 - 1. Gray Cement: Free of wax or oil, compatible with subsequently applied finishes or coverings, delivered in unopened labeled containers.
- B. Concrete Curing Paper: ASTM C 171, non-staining reinforced type.

2.08 PATCHING MATERIAL:

- A. Bonding Agent: LARSON PRODUCTS "Weldcrete," W.R. GRACE "Daraweld" or SONNEBORN-CONTECH "Soncrete."
- B. Patching Mortar: Latex modified Portland Cement mortar. Provide CUSTOM BUILDING PRODUCTS "Fix-a-crete."

2.09 PROPORTIONING:

- A. Proportioning shall be by weight of loose, dry material, 94 pounds of cement shall be considered 1 cubic foot. Fine aggregate volume shall be at least 35% of the sum of the separate fine and coarse aggregate volumes. Weighing equipment shall be accurate to within 1 pound and be adjustable for varying aggregate moisture content. A beam auxiliary shall register any part of the last 100 pounds of each aggregate. The aggregate hopper shall have a volume adjustment.
- B. Accurately control the proportions, water content, and air content.

- C. Waterproofing Admixture: Add to all concrete used for exposed roof slabs, slabs on grade and walls against grade. Add in accordance with manufacturer's instructions.
- D. Admixture (other than waterproofing and integral color): If admixture is used, conform to type specified. Quantity per sack of cement and method of using admixture shall be in accordance with recommendations of manufacturer and laboratory furnishing mix design.
- E. Non-shrink Grout: Pre-proportioned, or job mixed. For job-mix: one part, by weight, metallic aggregate mix; one part Portland cement; one part fine aggregate; and enough water for flowable consistency.
- F. Cement Grout: One part by volume Portland cement and 2 1/2 parts fine aggregate. Mix dry. Add just enough water to make mixture flow under its own weight.
- G. Dry Pack: One part by volume Portland cement and 2 1/2 parts fine aggregate, mixed dry. Add just enough water to dampen mix to a cohesive packing or tamping consistency.
- H. Patching Mortar: Mix liquid. Combine dry mix with liquid and add water in proportions recommended by manufacturer.

2.10 MIX DESIGN:

- A. Prepare design mixes for each type and strength of concrete indicated on plans.
 - 1. Proportions: For each material including admixtures and water, state water-cement ratio and maximum allowable water content, using not less than the minimum cement content required in paragraphs "proportioning."
 - 2. Materials: Manufacturer's name, designation and source of each material.
 - 3. Aggregate: Conform to LABC Section 91.2603.3.
 - 4. Modified Mix: Same as other concrete types except remove 50% of the coarse aggregate.

2.11 CONCRETE TYPES:

- A. Refer to structural drawings for specific uses and locations.
- B. Specified strengths measured at 28 days.
 - 1. Standard Weight Concrete: 3250 psi. (560C-3250) minimum unless specified higher.

2.12 MIXING CONCRETE:

- A. Ready-Mixed Concrete: Concrete shall be supplied by an established commercial ready-mix plant conforming to ASTM C 94.

1. Truck Mixers: Minimum 2 cu. yd. capacity, equipped with accurate revolution counter. Operate at rated speed. Discontinue use of mixers producing unsatisfactory concrete or showing more than 10% difference in sand-cement or water-cement ratios in samples taken from front, center and back of mixer.
 2. Mixing Time: Total at least 15 minutes, with at least 5 minutes immediately after addition of water, and at least 10 minutes just before discharging.
 3. Mixing Water: Withhold 2 1/2 gallons per cubic yard from predetermined water content. All or part thereof may be added at site, as directed.
- B. Re-tempered Concrete: Concrete not placed within 90 minutes after water is introduced into mix or which has stood for 30 minutes after leaving mixer shall not be used.

III - EXECUTION

3.01 FORMS:

- A. Design, erect, support, brace and maintain formwork to support vertical and lateral loads that might be applied until such loads can be supported by concrete structure. Construct formwork so concrete members and structures are of correct size, shape, alignment, elevation and position. Comply with ACI 347.
- B. Design and fabricate formwork to be readily removable without impact, shock or damage to cast-in-place concrete surfaces and adjacent materials.
- C. Provide temporary opening where interior area of formwork is inaccessible for cleanout, for inspection before concrete placement and for placement of concrete.
- D. Chamfer exposed corners and edges as indicated, using wood, metal, PVC or rubber chamfer strips fabricated to produce uniform smooth lines and tight edge joints.
- E. Form Ties: Factory fabricated, adjustable length, removable or snap-off metal form ties, designed to prevent form deflection, and to prevent spalling concrete surfaces upon removal.
- G. Provide openings in formwork to accommodate work of other trades. Accurately place and securely support items build into forms.

3.02 VAPOR BARRIER:

- A. Place interior slabs on grade over vapor barrier consisting of 2 inch bed of washed natural sand over vapor barrier sheet. Turn up edges of vapor barrier 2 inches. Lap edges 6". Tape and seal all edge laps and penetrations. Roll sub-grade smooth prior to placing vapor barrier.
 1. Omit stakes at metal joints occurring over vapor barrier. Use screed pads

to hold screed posts. Do not pierce vapor barrier.

2. Do not disturb or damage vapor barrier while placing metal formed joints and concrete reinforcing. If damage does occur, repair areas before placing concrete. Use vapor barrier material, lapped over damaged areas minimum 6" in all directions and seal.

3.03 JOINTS:

- A. Provide construction, isolation, and control joints as indicated or required. Locate construction joints so as to not impair the strength and appearance of the structure. Place isolation and control joints in a slabs-on-ground to stabilize differential settlement and random cracking.
- B. Metal Formed Joint: "Key-Kold" type metal joint form. Set top of stakes 3/8" below slab surface elevation, spaced at 2'-0" o.c.. When concrete is not poured continuously over both sides of joint, the knockout anchors shall be bent at 45 degree angle into the pour. Finish the concrete to the top of the joint and burn in with hand trowel.

3.04 INSTALLATION OF EMBEDDED ITEMS:

- A. Set and build into the work anchorage devices and other embedded items required for other work that is attached to, or supported by cast-in-place concrete. Use setting diagrams, templates and instruction provided by others for locating and setting.

3.05 CONCRETE PLACEMENT:

- A. Pre-placement Inspection: Before placing concrete, inspect and complete formwork installation, reinforcing steel, and items to be embedded or cast-in. Notify other crafts to permit installation of their work; cooperate with other trades in setting such work. Moisten wood forms immediately before placing concrete where form coatings are not used.
- B. Coordinate the installation of joint materials and moisture barriers with placement of forms and reinforcing steel.
- C. Comply with ACI 304, placing concrete in a continuous operation within planned joints or sections. Do not begin placement until work of other trades affecting concrete is completed.
- D. Consolidate placed concrete using mechanical vibrating equipment with hand rodding and tamping, so that concrete is worked around reinforcement and other embedded items and into all part of forms.
- E. Maintain reinforcing in proper position during concrete placement operations.
- F. Tolerances: Variations in finish surfaces shall not exceed 1/8 inch in any direction along a 10 foot straightedge.
- G. Protect concrete from physical damage or reduced strength due to weather extremes during mixing, placement and curing.

1. In cold weather comply with ACI 306.
2. In hot weather comply with ACI 305.

3.06 FINISH OF FORMED SURFACES:

- A. Rough Form Finish: For formed concrete surfaces not exposed-to-view in the finish work, unless otherwise indicated. This is the concrete surface having texture imparted by form facing material used, with tie holes and defective areas repaired and patched and fins and other projections exceeding 1/4" in height rubbed down or chipped off.
- B. Smooth Form Finish: For formed concrete surfaces exposed-to-view, or that are to be covered with a coating material applied directly to concrete, or a covering material applied directly to concrete, such as waterproofing, damp-proofing, painting or other similar system. This is as-cast concrete surface obtained with selected form facing material, arranged orderly and symmetrically with a minimum of seams. Repair and patch defective areas with fins or other projections completely removed and smoothed.

3.07 SLAB FINISH:

- A. Non-Slip Broom Finish: Apply non-slip broom finish to exterior concrete paving.
 1. Immediately after trowel finishing, slightly roughen concrete surface by brooming with hair bristle broom perpendicular to main traffic route. Coordinate required final finish with Landscape Architect before application.
- B. Sealer: Apply to scheduled areas in accordance with manufacturer's printed instructions.

3.08 CONCRETE CURING:

- A. General: Protect freshly placed concrete from premature drying and excessive cold or hot temperatures.
 1. Start initial curing as soon as free water has disappeared from concrete surface after placing and finishing. Weather permitting, keep continuously moist for not less than 7 days.
 2. Begin final curing procedures immediately following initial curing and before concrete has dried. Continue final curing for at least 7 days in accordance with ACI 301 procedures. Avoid rapid drying at end of final curing period.
- B. Curing Methods: Perform curing of concrete by moist curing, by moisture retaining cover curing, by curing compound, and by combination thereof, as herein specified.
- C. Do not use membrane curing compounds on surfaces which are to be covered with coating material applied directly to concrete, liquid floor hardener, waterproofing, damp-proofing, membrane roofing, flooring, painting, and other

coatings and finish materials, unless otherwise acceptable to Architect.

- D. Curing Formed Surfaces: Cure formed concrete surfaces, including undersides of beams, supported slabs and other similar surface by moist curing with forms in place for full curing period or until forms are removed. If forms are removed, continue curing by methods specified above, as applicable.
- E. Curing Unformed Surfaces: Cure unformed surfaces, such as slabs, floor topping, and other flat surfaces by application of appropriate curing compound.

3.09 REMOVAL OF FORMS:

- A. Time: Remove forms after concrete has developed sufficient strength to sustain its own weight and superimposed loads, but not before the time listed below:
 - 1. Slabs: 1 day.

3.10 RE-USE OF FORMS:

- A. Clean and repair surfaces of forms to be re-used in the work. Split, frayed, delaminated or otherwise damaged form facing material will not be acceptable. Apply new form coating compound material to concrete contact surfaces as specified for new formwork.
- B. When forms are extended for successive concrete placement, thoroughly clean surfaces, remove fins and laitance, and tighten forms to close all joints. Align and secure joints to avoid offsets. Do not use "patched" forms for exposed concrete surfaces, except as acceptable to the Architect.

3.11 MISCELLANEOUS CONCRETE ITEMS:

- A. Equipment Bases: Form concrete bases for all mechanical and electrical equipment indicated on the drawings, including architectural, structural, mechanical, electrical, and plumbing drawings, in accordance with approved shop details furnished by the various trades. Corners shall be bullnosed and bases shall be coved.
 - 1. Set anchor bolts for machines and equipment to template at correct elevations, complying with certified diagrams or templates of manufacturer furnishing machines and equipment.
- B. Pits, Trenches, Curbs: Form and pour pits for valves, trenches, curbs, and miscellaneous concrete items. Steel trowel surfaces hard, dense and smooth with corners, intersections, and terminations rounded. Where structural details for minor structures listed above do not specify otherwise, walls, floors and covers shall be 6" thick, reinforced with #3 bars, 6" o.c. both ways at center of members.

3.12 CONCRETE SURFACE REPAIRS:

- A. Patching Defective Areas: Repair and patch defective areas with cement mortar immediately after removal of forms, when acceptable to the Agency Representative.

- B. Remove and replace concrete having defective surfaces if defects cannot be repaired to satisfaction of the Agency Representative.
- C. Do not leave exposed steel ties, clamps, in concrete. Solid pack holes resulting from form construction after flushing them with water. Fill tie wire, nail, bolt, nut, separator and core sample holes, which will be exposed within 24 hours after forms are stripped.
 - 1. Cut out honeycomb, rock pockets, voids over 1/4" in any dimension, and holes left by tie rods and bolts, down to sold concrete but, in no case to a depth of less than 1". Make edges of cuts perpendicular to the concrete surface. Thoroughly clean, dampen with water and brush-coat the area to be patched with specified bonding agent. Place patching mortar after bonding compound has dried.
 - 2. Match surrounding architectural concrete surfaces in color and texture. Make trial patch to determine color match.

3.13 FIELD QUALITY CONTROL:

- A. Slump Tests: Measure concrete consistency by the "Standard Method of Test for Slump of Portland Cement Concrete," ASTM Designation C 143. Make this test at point of discharge twice each day or partial day's run. A complete and accurate record of these tests shall be kept by the inspector. Maximum slump shall be as follows:
 - 1. Walls 4" to 5".
 - 2. Floor slab on grade, 3" to 4".
- B. Cylinder Samples: Make concrete test cylinder samples in accordance with ASTM C 31.

3.14 DEFECTIVE CONCRETE:

- A. Mix Proportions: If ultimate compressive strength of test cylinders fall below minimum assumed in design, proportions of concrete mixes for remaining portion of structure shall be adjusted as required to produce concrete of design strength.
- B. Test Cores: Should the required test cylinders fail to show design compressive strength, test cores shall be taken at locations designated by Architect. Cores shall be tested complying with LABC Section 91.2604.3.5.1. If results show compressive strength to be less than design stress, concrete shall be deemed defective and shall be replaced in a manner acceptable to the Agency Representative, and the Building Department. Cost of cores, tests, and patching shall be paid by Contractor. Coring holes shall be dry-packed.
- C. Concrete work not formed as indicated, not true to intended alignment, not plumb, level, or true to intended grades, with embedded sawdust or debris, and not fully conforming to the provisions of these specifications shall be deemed defective and shall be removed from the job site as directed by the Agency Representative and shall be replaced with concrete complying with specification requirements.

END OF SECTION

SECTION 03310 - FOOTINGS AND FOUNDATIONS

PART 1 - GENERAL

1.01 RELATED DOCUMENTS:

The provisions of the "Standard Specifications for Public Works Construction" shall apply except as modified herein.

1.02 SCOPE:

Work included: Provide all footings and foundations, complete in place, as indicated on the drawings, specified herein, and needed for a complete and proper installation.

1.03 QUALITY ASSURANCE:

Qualifications of Installers:

Throughout the progress of installation of the work of this Section, provide at least one person who shall be thoroughly familiar with the specified requirements, completely trained and experienced in the necessary skills, and who shall be present at the site and shall direct all work performed under this Section.

Use adequate number of skilled workers to ensure installation in strict accordance with the approved design.

Details provided on plans with notes. If notes conflict with book specification, the more stringent shall apply.

PART 2 - MATERIALS

2.01 GENERAL:

All materials shall conform to Section 201 of the latest edition of the "Standard Specifications for Public Works Construction."

- A. Portland Cement: Section 201-1.2.1, Type I or II, low alkali. Only one brand of cement shall be used.
- B. Aggregates: Conform to Section 201-1.2.2.
- C. Water shall be clean and free from deleterious materials.
- D. Form lumber shall be uniform construction grade or better.
- E. Provide reinforcement steel as indicated on the drawings and in conformance with the requirements of the uniform building code latest edition.

PART 3 – EXECUTION

3.01 GENERAL:

All materials shall conform to Section 302.6 of the latest edition of the “Standard Specifications for Public Works Construction” except as modified herein.

3.02 CONCRETE MIX:

- A. The Contractor shall supply and pay all costs for concrete mix designs.
- B. In no case shall concrete contain less than 6 sacks of cement per cubic yard, and a maximum of 7 gallons of water per sack of cement.
- C. Concrete mixes shall be proportioned by the using of 1-inch maximum size aggregate.
- D. Concrete shall develop an minimum compressive strength at 28 days of 3250 P.S.I.
- E. The maximum slump for slab on grade shall be 4".

3.03 TESTS AND INSPECTION:

- A. The quality and quantity of materials used in the concrete shall be controlled at the batch plant by a Weighmaster.
- B. Contractor shall deliver two copies of each load ticket to the Agency Representative.

3.04 FORMWORK:

- A. Form shall be substantial, unyielding, true to line and grade, and shall conform to the dimensions indicated on the drawings.
- B. Edge of footing shall not cross property line or right of way line.

3.05 TRANSPORTATION AND PLACING CONCRETE:

Responsibility for proper placing, compacting and finishing rests with the Contractor. Finished work showing voids and separation of aggregates will not be accepted.

3.06 CURING CONCRETE:

All concrete surfaces shall be kept continuously wet for a period of not less than 36 hours by ponding, soaking or spraying. Following this 36 hour period, the concrete shall be protected from loss of moisture by an approved liquid curing compound.

END OF SECTION

SECTION 03380 - CONCRETE CURING**PART 1 ■ GENERAL****1.01 GENERAL CONDITIONS**

Requirements of the Contract Documents, including but not limited to, the General, Special, and Technical Provisions, apply to work in this Section with the same force and effect as though repeated in full herein.

1.02 SCOPE OF WORK

Furnish materials, labor, transportation, services, and equipment necessary to install all Concrete Curing related to the park as indicated on the Drawings complete as shown and as specified herein.

Related Work:

| | |
|------------------------|---------------|
| Concrete | Section 03010 |
| Footings & Foundations | Section 03310 |

1.03 REFERENCES

Comply with the applicable reference specifications as specified in the GENERAL PROVISIONS and in accordance with applicable laws, codes and regulations required by the Agency (City Moreno Valley, CA). Comply with the current provisions of the following Codes and Standards:

ASTM - American Society for Testing and Materials:

- ASTM C94 ■ Ready-Mixed Concrete.
- ASTM C150 ■ Portland Cement.
- ASTM C271 ■ Sheet Materials for Curing Concrete.
- ASTM C309 ■ Liquid Membrane-Forming Compounds for Curing Concrete.

ACI ■ American Concrete Institute:

- ACI 301 ■ Specifications for Structural Concrete for Buildings.
- ACI 305 ■ Recommended Practice for Hot Weather Concreting.
- ACI 306 ■ Recommended Practice for Cold Weather Concreting.
- ACI 318 ■ Building Code Requirements for Reinforced Concrete.

CBC ■ 2016 Edition of the California Building Code

1.04 SUBMITTALS

In accordance with Contract Documents, General, Special and Technical Provisions.

Submit product data and manufacturer's instructions for:

- Curing compound.
- Proprietary cleaning agents.
- Plastic film for curing.
- Surface retarders.

1.05 DELIVERY, STORAGE, AND HANDLING

Store materials in dry and protected locations and protect from damage.

1.06 SITE CONDITIONS

Environmental Requirements: Protect concrete against extreme cold and heat, frost, rapid drying, and damage by rain.

PART 2 - PRODUCTS

2.01 MATERIALS

Curing Compound: ASTM C 309, non-staining, all resin type, white-pigmented, compatible with color admixture.

Acceptable Product: Burke Spartan-Cote Cure or equal. Curing Compound Application Rate: 350 sq. ft./U.S. Gallon (12.5m sq./L)

PART 3 - EXECUTION

3.01 CURING

Protect concrete surfaces against rapid drying. Keep sealed with cure agent for necessary amount of time to reach concrete strength and inhibit moisture loss after placing per manufacturer's recommendation.

Apply to exposed surface of concrete as soon as manufacturer recommends with an airless sprayer.

Apply to sides of concrete paving upon removal of form boards.

Meet requirements of manufacturer's current printed application instructions.

Uniformly apply 2 coats and apply the second coat at right angle to first coat.

Apply compound to form a continuous, uniform, coherent film that will not check, crack, or peel.

Do not apply to concrete that is still bleeding, or has a visible water sheen on the surface.

Protect paving surfaces from foot traffic with scuff-proof paper.

Immediately re-coat damaged areas of curing compound.

Protect surface from water, adjacent concrete work and debris.

3.02 CLEANUP

Contractor to remove all cure agent from concrete surface with power washing equipment and soft brush not causing abrasion to finish work surface prior to final inspection. No Cure Agent shall be present on any surfaces for final inspection acceptance. Remove debris and trash resulting from specified work.

END OF SECTION

SPECIAL PROVISIONS
PART 2 – TECHNICAL PROVISIONS 0702-132

Attachment: Special Provisions PCS HSG GR-JFK RENO (2845 : APPROVE AND EXECUTE AGREEMENT FOR THE INSTALLATION OF A

DIVISION 4

SECTION 13000 - PREFABRICATED RESTROOM BUILDING

A. General, Specifications and Clarification of Prefabricated Building and Site Installation

1. This portion of the bid specifications does not follow the CSI standard format as the prefabricated structure in this bid is an **offsite constructed "product"** and not "typical" general construction.
2. The **installation of the product on site is general construction**, which must be coordinated between the general contractor and the subcontractor. Specifications for the building foundation/pad shall be provided herein by the specified design/build subcontractor. Due to the responsibility of the specified building subcontractor for architecture, engineering and a five-year warranty, the site pad/foundation must meet the subcontractor's design so the pad and building can be considered from a single source for warranty purposes. The subcontractor must accept the pad and compactions tests before they take responsibility for the entire system under their warranty.

B. Architectural Design/Engineering and Insurance Responsibility

1. While the City of Moreno Valley has provided bid specifications and a design for the building, the building design/build subcontractor remains legally responsible for architecture, engineering, and all applicable building, safety, health, fire, and accessibility code compliance. Since they hold professional design responsibility to the owner, the building subcontractor must furnish certification that they provide product liability insurance in the amounts required by the general specifications **to cover property damage and personal injury**. Final drawings shall be stamped by a California engineer and California Department of Housing, suitable for local permitting.

C. Errors and Omissions Insurance

1. The building design/build subcontractor must also provide an additional Professional Architectural and Engineering Errors and Omissions insurance, in the minimum amount of \$2,000,000, **to cover claims against the owner or the general contractor for State and Federal ADA handicapped accessibility and other design/engineering code issues**. This Errors and Omission Policy must remain in effect for 5 years from the completion and owner acceptance of the project. Product liability insurance (since it does not cover professional design responsibility only) will be insufficient for this bid and will be cause for rejection of the bidder.

D. Insurance for the Building offsite, while in transit, and/or on site until turn over and final owner acceptance

1. The subcontractor may request invoicing for a percentage of building completion in-plant, monthly. Under UCC law, this means that the subcontractor is turning over responsibility for the portion invoiced to the owner yet the building will not be on the owner's property and may not be covered by the owners insurance. Therefore, the building subcontractor must provide a separate insurance policy insuring the owner and general contractor as additionally insured for liability, damage and/or vandalism to the building while in the manufacturing facility, while in transit, and/or while in storage at a certified bonded storage facility or at the final project site for up to \$200,000 for each prefabricated building module, until the building is final accepted by owner.

E. General Contractor Coordination with Design/Build Subcontractor

1. The specified prefabricated public restroom building require coordination between the

General Contractor (who prepares the site pad and delivery access for the prefabricated building) and the prefabricated restroom building subcontractor (who completes the architectural design, engineering, off-site building construction, delivery and installation on site.) The specified prefabricated restroom building specifications include unique components/systems which are custom to the restroom building subcontractor. Since the restroom subcontractor is responsible for design, additional insurance requirements for errors and omissions is required.

F. General Contractor, General Scope of Work

1. The general contractor for this project is responsible for the site survey and staking the building locations, finished slab survey elevations and marking on site, construction and compaction of the required building pads; access to the site for a large crane and tractor trailers delivering the prefabricated building; providing water, sewer, and power at a point of connection (POC) within 6 feet of the building and at the depth required by the building subcontractor and local code; and the installation of any sidewalks outside the building footprint.
2. The general contractor is responsible for verification to the building subcontractor design/build firm that there are no unanticipated site delivery issues such as overhead wires, trees, tree roots, or existing grade changes and that prevent a clear path of travel between a roadway and the final site exists for a tractor trailer and crane to expedite delivery. The design/build subcontractor requires that the general contractor certify that the required delivery crane must be able to set the building modules within 35' distance from the center of the building to the center of the crane hoist.

G. Prefabricated Restroom Building, General Scope of Work:

1. The prefabricated restroom building specialist will provide to the general contractor final building design architectural drawings and engineering calculations under the responsibility of a licensed structural engineer, in compliance with all local, state and federal codes. The design/build subcontractor shall construct the building offsite as a permanently relocatable building, transport it to the final required destination, and install the building turnkey, on a general contractor prepared pad per the drawings included in this bid.

H. Licensing:

The subcontractor must comply with all the State of California; Department of Housing and Community Development, prefabricated "Commercial Modular Requirements" as follows:

1. The building *manufacturer* must be licensed by the State of California, Department of Housing and Community Development as a manufacturer.
2. The selling dealer (if applicable) must be a California licensed dealer and present their license for verification with the bid.
3. The licensed dealer must also possess a State of California Contractors License Board Class B License and present their license for verification with the bid.

I. Bid Standard for the Prefabricated Restroom Building

1. The City of Moreno Valley understands that there are several firms who design and build various types of public restroom building in varying quality and architectural styles, using similar or different construction methods and materials. For the purpose of this bid, the owner has selected:

Public Restroom Company, 2587 Business Parkway, Minden, NV 89423 and specifies herein that this firm is the standard for architectural design, safety, green design, code compliance, and site specific compatibility. PRC is also the standard of building

Attachment: Special Provisions PCS HSG GR-JFK RENO (2845 : APPROVE AND EXECUTE AGREEMENT FOR THE INSTALLATION OF A

performance and quality for the 50 year building design-life with low-maintenance based upon the longevity of the materials selected.

Contact: **Chad Kaufman, VP, Sales and Marketing**
 Phone: **888-888-2060 extension 109**
 Fax: **888-888-1448**
 Email: Chad@PublicRestroomCompany.com
 Web: www.publicrestroomcompany.com

2. Other firms quoting “or equal” whose criteria and standards do not comply will be rejected.
3. Pre-cast concrete structures are not acceptable.

J. “Or Equal Restroom Design/Build Subcontractors”

1. The City of Moreno Valley may also allow other firms to become qualified to bid, but any firms so authorized to bid must fully comply with these bid specifications and plans, or be subject to post bid rejection. **In order to provide full and open competition, other firms may request approval as an “or equal”, however the Contractor must provide separate line item pricing for the “or equal” restroom in addition to pricing for the “specified” restroom. The City of Moreno Valley will decide which restroom product they want, and not jeopardize the Contractors bid if and when presenting an “or equal” solution.**

- a) Or Equal applicant shall provide **with their bid submission**, scaled floor plans and elevations, to show general architectural design criteria is met.
- b) Or Equal applicant shall provide **with their bid submission**, a written list of each and every deviation from the published bid specifications/plans. Lack of specificity to each deviation from the bid specifications will be cause for rejection.
- c) Or Equal applicant shall provide **with their bid submission**, manufacturer’s certification of test compliance from a national independent testing laboratory (within the past year) to support the claim for absorption resistance of the slab type that will be used in their proposed restroom. The written report must state the concrete compressive strength (minimum of 7,000 PSI) and absorption resistance (not greater than 3%) per ASTM standard #C39 and #C642, respectively.
- d) Or Equal applicant must provide a list of every building they designed and built over the last 3 years utilizing the same building materials/systems design criteria as published in this bid. Provide date of building bid, date of completion, and most knowledgeable owner contact.
- e) Or equal applicant shall provide certification of the special insurance required in this bid.
- f) Or Equal applicant shall be responsible for and bear all cost for architecture, plan checks, design and structural engineering and all fees in obtaining approvals and permits from applicable agencies.
- g) City of Moreno Valley or their consultant will be solely responsible for the decision to accept or reject the “or equal” submission.

J. Certificate of Off-site Inspection and Construction Compliance, Provision for Maintenance Manuals, and Warranty

1. The off-site restroom construction requires that a licensed third party inspection firm provide the owner and the local building official with certification and compliance for the building with the approved plans and specifications. A certificate of compliance shall be issued by this inspector to the local building official to provide certification that the building meet and or exceed the approved plans and applicable codes.
2. At the project conclusion, the building subcontractor shall furnish two sets of complete maintenance manuals including a trouble shooting guide, location of manufacturers of key components for replacement parts together with final as-built plans, and a **five (5) year warranty** to the owner or general contractor.

K. Site Scope of Work by General Contractor

The general contractor shall prepare the restroom building subgrade to receive the prefabricated building in accordance with the bid subgrade preparation drawings or foundation plan.

1. The building subgrade/footings shall be constructed per the bid drawings
2. The General Contractor shall provide water point of service at 30" below finished building slabs; sewer at 24" below the finished building slabs; and electrical at 36" below the finished building slabs or other per bid plans.
3. General Contractor shall coordinate with restroom subcontractor to provide full site delivery access for a 70' tractor-trailer and hydro crane to the final building sites.
4. If the final site access is over existing sidewalks, utilities, or landscaping, the General Contractor shall be responsible for plating and or tree trimming, utility line removal, or other to protect any existing conditions.
5. The hydro crane must be able to locate no greater than 35' from the center point of the building to the center point of the crane.
6. The utilities shall be furnished per bid site plans at specified points of connection (POC) nominally 6' from the building lines.
7. General contractor shall furnish and install final grading, landscaping and sidewalks.

M. Connection to Utilities

1. The restroom subcontractor will stub-out: Electrical, Water, and Sewer at the proper POINT OF CONNECTION AND AT THE PROPER ELEVATION BELOW GRADE, for this project. Restroom subcontractor shall provide final hook up of the water from building to POC; sewer hookup to POC; and electrical sleeve from building panels to POC only. Final utility connections shall be by General Contractor or others. General contractor shall flush the water lines thoroughly before making final water connection to the building. **Thoroughly flushing the water lines for AT LEAST 30 MINUTES is critical to ensure that the new code required low-flow fixtures and flush valves that are extremely sensitive to particulate matter in the water will not malfunction.**

N. Concrete Slab, Required Independent Testing Laboratory Certification:

1. The prefabricated building slabs special concrete technology claims to be water and urine resistant for life due to special additive technology. The building subcontractor must furnish a test certification of compliance from a national independent testing laboratory to support the claim for absorption resistance. The written report must state the concrete compressive strength (minimum of 7,000 PSI) and absorption resistance (not greater than 3%) per ASTM standard #C642 and #C39 respectively. Since this non-absorbency capability is so significant, the design/build subcontractor must provide a general certification of compliance.

O. Prefabricated Restroom Building:

1. The City of Moreno Valley has evaluated several prefabricated restroom building subcontractors. This bid requires such building be used in lieu of site-built traditional construction because of the unique built-in advantages guaranteed by the design/build firm. This technology includes many new innovations such as non-absorbent concrete; anti-microbial components to reduce health risks; built in vandal resistance design; lowered maintenance and long term warranties that reduce owner risk for failure. The specifications below are written around this new technology.

P. Mat Engineered Concrete Building Slab/Foundation:

1. The mat engineered 8" thick slab/foundation shall be engineered and constructed to withstand the transportation weight of the building without cracking and to resist absorption from any liquids deposited on the surface. The concrete slab shall be constructed inside a steel angle curb, reinforced with dual mats (tension and compression,) and poured with a custom concrete formula with special admixtures to create a finished slab that is water proof for life.
2. The building slab/foundation will include the area under the covered entry.
3. Perimeter Steel Curb: 5/16" 50,000 kip steel 6" X 6" welded continuous angle.
4. Rebar Steel Mat: Two layers of 40,000 tensile steel rebar in varying sizes per engineers requirements, including a perimeter structural continuous grade beam design inside the exterior steel angle and at any other location deemed by the engineer of record as required for the use intended. In coastal locations or when required for corrosion resistance rebar shall be epoxy coated or fiberglass to resist permanent corrosion. Rebar mats shall be wire tied to code with a minimum of three turns of the wire and overlaps shall be minimum of 15 diameters for any connection.
5. All slab openings shall be surrounded with two layers of steel collars as required by the engineer of record to stop corner cracking and to reinforce the openings for lifting.
6. 1" thick by 3" minimum length threaded nuts shall be welded to the steel perimeter frame with continuous ¼" fillet welds. Nuts shall be welded to common steel plates per the engineer of records design and attached to the interior steel rebar structural mats.
7. The engineer of record shall provide lifting locations with sufficient reinforcement to allow the safe lifting of the entire designed weight of the structure with dual 1" steel bolts and washers at each lifting location. The number of lifting locations with each location fitted with removable ¾" 8" X 8" 50,000 tensile strength steel angles shall be determined by the engineer of record.
8. The slab shall be poured over a 1" thick steel plate table. The concrete mix design shall not exceed a 3" slump and shall be stinger vibrated for maximum consolidation. All floors shall slope to any floor drains within each room and if no floor drain is present the floor should not slope. The surface shall be a very light broom that should meet a coefficient of friction on the surface of .06. Birdbaths shall be cause for rejection.
9. The steel perimeter angle will remain below the concrete surface by nominal two inches to prevent corrosion. After the site concrete sidewalks are poured, the joint shall be full flow sealed with self-leveling grey urethane caulk to prevent penetration of water into the joint.
10. The building shall be designed for future relocation and shall provide protection for the lifting openings in the mat slab so that the threaded openings will be available for future use if needed.
11. The building systems shall be designed for placement on a general contractor site prepared class 2 building pad/and or footings as required by code, per the bid drawings, suitable for 1500 pounds soil bearing capacity minimum. Any soils survey (if necessary) shall be by owner or engineer of record.

Q. Exterior & Interior Masonry Block Walls

1. The exterior walls shall be 4" and or 6" thick CMU per State of California codes or engineering for wind and seismic to height shown in bid plans. The interior walls shall be 4" CMU, per engineers recommendations.
2. The 8" mat engineered concrete slab shall be cured a minimum of 7 days. Holes for vertical dowels shall be drilled into the mat engineered slab avoiding any grade beams or other structural reinforcement. Once the holes are drilled, blow out the remaining material and using two part structural epoxy, wet set the #3 or #4 vertical rebar (as specified on the engineering calculations into holes drilled to the depth per the engineer of record requirements. Each rebar shall be held vertical to allow equal epoxy support to each dowel during the drying period. Engineering calculations require that rebar shall be installed in each concrete block center void or every block hole. The engineered uplift on each rebar shall be sufficient to restrain any load imposed on the masonry block wall for vertical rebar pull out from the concrete mat engineered slab.
3. The block walls shall be nominal 8" x 16" CMU. The building corners shall have special corner return block that matches the exterior finish and creates a uniform appearance. All CMU shall be custom fabricated with an enlarged interior hole for placement of the grout and vertical rebar.

R. Roof System

1. Restroom roof shall be 24 gauge steel, Kynar 500 factory-finished (copper penny color) standing seam roof panels, over a structural steel tubular cross frame, over steel tubular truss frames. The front, mid and rear steel tubular trusses shall be welded to steel plate imbeds in the top of the masonry walls.
2. Building roof rake and fascia shall be tubular steel, painted in a color selected by owner.
3. The roof design shall exceed compliance with local code at 20 PSF live load and wind load "C".
4. The restroom ventilation screens (described in a following section) shall be attached to the truss frames and vandal resistant. Roof color shall be determined by owner and selected from the color chart by restroom supplier.
5. The truss at the gable end shall be 6" x 6" structural steel with 6" x 6" structural steel posts and horizontal beam. They shall be primed and painted in a color selected by owner.

S. Interior Wall Finish:

1. Interior precision CMU block and partitions masonry walls shall be covered with 8" x 8" porcelain tile set in epoxy mortar and epoxy grout, color to be selected by owner. Pony and gable walls shall be Kynar 500 factory painted corrugated 24 gauge steel panels to match roof.

T. Exterior Wall Finish, Masonry and Gable

1. The building exterior finish shall be a mix of scored split-face (including post bases) and precision 8" x 16" CMU to wall height per the exterior elevations in the bid plans. The precision block shall be covered with an acrylic stucco finish with light sand texture. The block and stucco shall be coated with 2-4 mil layers of special 7-day curing block fillers and painted with two additional layers of industrial high solids, gloss enamel to a 4 mil thickness. Color to be selected by Owner.

U. Gable Ventilation System (Restroom)

1. Shall be woven ¼" X 1" X 1", 316T, stainless steel wire mesh set in welded stainless steel angles attached to the CMU wall with vandal resistant stainless steel screws, per plans.

V. Doors and Gates

1. The restroom entry doors shall be 7'-0" high custom fabricated steel gates; hung on a

- single continuous, 1 million cycle, aluminum gear hinge with stainless steel vandal resistant screws at nominal 4" on center. Gates shall be primed and painted in a color selected by owner.
2. All other entry doors shall be 7' 0" high, custom fabricated, 14 gauge steel; reinforced with 14 gauge concealed steel ribs welded at 6" intervals on each face.
 3. Doors shall be hung on a single continuous, 1 million cycle, aluminum gear hinge with stainless steel vandal resistant screws at nominal 4" on center. The doors shall weigh nominally 176 lbs each for a 36" X 84" door. Custom fabricated 14 gauge steel door jambs with 4" steel heads shall be welded to the steel cap beam and be solid filled with 3000 psi masonry grout mix.
 4. The restroom gate-doors shall have tubular "C-shaped", anti-microbial door pulls (one each side). All other exterior entry doors shall have a custom-fabricated ¼" thick stainless steel "Z-shaped" anti-microbial pull handles and Schlage B-600 series commercial series dead bolts.
 5. The door closer (restroom entry gate-doors only) shall be "LCN" heavy duty #4210 Series, fastened to a structural reinforced door plate per door manufacturer design. Stainless steel vandal resistant fasteners shall be used on all hardware.
 6. Exterior shutter louvers shall be custom fabricated tubular steel, attached to the masonry exterior wall with vandal resistant fasteners, per bid elevations. There shall be a 12" x 48" opening in the block wall behind each shutter to facilitate natural air ventilation. Shutters shall be primed and painted in a color selected by owner.
 7. Exterior sightcreens at restroom entry doors shall be 14 gauge B-Deck panels attached to a welded steel tube frame, primed and painted in a color selected by Owner.

W. Specialties

1. All specialty washroom equipment shall be commercial grade stainless steel fastened securely to walls with vandal resistant stainless steel screws to avoid removal by vandals as follows:
2. Toilet paper holders shall be, covered, three-roll, 14 gauge stainless steel with lock. The angled design shall prevent vandals from standing on the top and causing damage. Toilet paper holders shall be attached to block walls with 4 epoxy bedded vandal resistant stainless steel fasteners.
3. Stainless steel grab bars to code shall be 1 ¼" minimum exposed fastener vandal resistant design and installed at each accessible water closet.
4. Cast Aluminum California Title-24 compliant signage shall be recessed into block surface flush with masonry exterior. Signs shall have raised pointed Braille tips and shall be blind secured with epoxy adhesive and stainless steel fasteners.
5. Soap dispensers shall be large single stainless steel tank remote reservoir with float for capacity reading, concealed in the mechanical room, with a through/wall stainless steel pipe dispenser at each lavatory.
6. The toilet partition walls shall be concrete precision block finished the same as the building interior walls, structurally reinforced to support load of 350 lbs minimum and raised 12" above finished floor. The toilet partition doors shall be custom fabricated, ¾" Solid Color Composite panels, color to be "Slate." The doors are secured by stainless steel fasteners to a continuous stainless steel spring-loaded 54" hinge and the door latch shall be custom-fabricated stainless steel design that is vandal-resistant and has an anti-microbial finish. There shall be a coat hook on the back of each partition door.
7. A recessed hinged door Knox Box shall be installed in the front of the building at drinking fountain alcove for fire department access.

X. Plumbing:

1. Building shall be fully compliant with all applicable codes and requirements, satisfying the City of Moreno Valley Building and Safety Division. Additionally, the following codes

and requirements shall be adhered to:

- a) All applicable State of California Building Codes. Latest edition applicable.
 - b) California Plumbing Code. Latest edition applicable.
 - c) California Green Building Standards
2. GENERAL: All components and fabrications shall be designed to reduce life cycle maintenance, be compatible with current maintenance spare parts, and shall be listed in a spare parts/maintenance manual (two copies) delivered in utility chase of building.
 3. WATER PIPING: Shall be type L copper soldered per code above grade and type K with silver solder below grade. All water piping shall be designed and constructed with high and low point drain fittings. All piping shall be mounted on Uni-strut wall brackets with neoprene isolators, to code.
 4. WATER PRESSURE GAUGE/VALVE COMBO: install three commercial grade industrial water pressure gauges (one on incoming line, one at pressure regulator valve and one after water filter), isolation ball valves, 150 PSI pressure regulator with wye strainer, 10-micron water filter with clear canister, and check valve.
 5. PLUMBING FAUCETS, ISOLATION VALVES AND ACTUATORS: All fixtures except those with flush valves shall be isolated with ball valves for each fixture, concealed antimicrobial impregnated flush handle valves, and metered push-button lavatory faucets.
 6. DWV PIPING: DWV piping shall be concealed behind the wall. DWV piping shall be PVC DWV, solvent welded, for all concealed piping. A cast iron no hub DWV vent pipe with a cast iron roof mounted vandal cap vent shall be required, through the roof.
 7. REMOVABLE PIPE TRAPS: all floor drain, sink drain, and waste traps shall be removable for maintenance. Floor drains shall be trapped behind the wall in the utility chase using a combination waste and vent system. Floor drains shall be increased two pipe sizes over standard to allow code use. Trap primers for restroom floor drains shall not be used as restroom maintenance is hose-down. All surface mounted utility chase piping shall be mounted on Uni-strut with plastic isolators to code. Sink drain traps shall be concealed behind the utility chase walls where maintenance staff can access all plumbing.
 8. PLUMBING FIXTURES: Plumbing fixtures shall be 14 gauge, 316 stainless steel manufactured by Acorn. Toilets shall be wall hung, rear discharge, with concealed, ADA-compliant, button-type, flush valves. Toilet seats shall be black solid core plastic, non-flammable construction with continuous stainless steel concealed self-checking hinges. Lavatories shall have concealed remote traps behind the mechanical wall.
Schedule of fixtures:
 - a. Water Closets: Acorn Penal-Ware, 1675-W-1-HET-FVBO-9-ADA-PFS
 - b. Water Closet Flush Valve: Zurn ZH6152AV-HET-MB
 - c. Urinal: Acorn Penal Ware: Acorn 1709HEU-1-0.125 GPF-FVBO
 - d. Urinal Flush Valve: Zurn ZH6195AV-MB-BG-ULF
 - e. Lavatories: Acorn Penal-ware 1652LRB-1-DMS-03-M-H1
 - f. Hi-Lo Drinking Fountain: Murdock GSE64-FG
 - g. Bottle Filler: Murdock BF-3 mounted above accessible drinking fountain.
 9. FLOOR GRATES: Removable 350 lbs. per square foot pultruded fiberglass non-skid floor grates shall be installed over every opening in the utility chase for OSHA compliance.
 10. HOSE BIB: There shall be one Woodford 24B hose bib provided in the utility chase.
 11. HOSE REEL: There shall be one commercial grade Rapid Reel hose reel (1041-GH) with a 75' commercial grade hose.

Y. Electrical:

1. GENERAL: Electrical system and components shall be commercial grade or better and piping conduits shall be installed on commercial Uni-strut wall hangers. Interior electrical

- lighting fixtures in public areas shall provide lifetime manufacturer's warranty.
2. **PANEL/WIRING:** One 100 amp, 120/240v, single-phase, industrial grade Panel Board, Square "D" QO series with 100 amp main circuit breaker, shall be mounted in the utility chase in the restroom building. All breakers shall be snap-on type, minimum 10,000 A.I.C. RMS (Sym). Wiring shall be copper wire #12 min in EMT piping with compression fittings.
 3. **PIPING:** All piping shall be surface mounted to the masonry block walls with minimum of 2" fastener penetration. EMT conduit shall be compression type. Main panel shall maintain a 30" X 36" safety code required clear space, floor to 6' above finished floor.
 8. **HAND DRYERS:** Shall be concealed Fastaire HD03, with operating equipment remotely located in utility chase.
 4. **WATER HEATERS:** Shall be tankless, Stiebel-Eltron DHC-8/10-E Water heater shall be located in the utility chase. There shall be a tempering valve servicing the restroom lavatories.
 5. **EXTERIOR LIGHTING:** Luminaire AEL-12, 10 watt, LED Dark Sky Compliant, vandal resistant, high-impact polycarbonate lens fixtures shall be installed (one above each restroom entry door and one at the gable end of the storage room.) One Luminaire SWP610, 18 watt, LED vandal resistant high-impact polycarbonate lens fixtures shall be installed in the alcove soffit above the drinking fountains.
 6. **INTERIOR LIGHTING:** Luminaire SWP610HO, 20 watt, LED vandal resistant high-impact polycarbonate lens fixtures shall be installed in the restrooms per plans (one in each restroom). The chase shall have two 4' single-tube, 18 watt LED fixture, suitable for wet locations, with a single switch at door entry. The storage room shall have two double-tube, 36 watt LED fixture, suitable for wet location.
 7. **LIGHTING CONTROL:** All interior restroom lighting shall be controlled by a time clock mounted in the utility chase and 2 bypass switches (one for interior lighting and one for exterior lighting), so maintenance staff can check operation during daylight hours. A single photo cell, roof mounted, and shall control all exterior lighting.
 8. **ELECTRICAL OUTLETS:** One (1) commercial spec grade duplex outlet shall be located in the utility chase adjacent to the panel and two in the storage room.
 9. **MAGNETIC DOOR LOCKING SYSTEM:** Securitron Magnalock Model M62 magnetic time clock controlled lock system shall be furnished for each public entry door. An illuminated "touch-sense" button (in both English and Spanish) shall be installed adjacent to each door for emergency egress in the event that the system magnetic lock engages. System shall also remain operating for a minimum two-hour power out cycle by a self-charging battery backup.

Z. Shipping Protection

The building, while traveling over roads to the destination may encounter inclement weather or road grime that could require substantial cleaning when it arrives on site. The building shall be shrink-wrapped before transportation and sufficiently strong to arrive at the owner site intact for exterior finish protection. Materials removed on site shall be disposed of and recycled by restroom building install staff.

AA. Certifications

Building shall be certified in compliance with the plan approval by the State of California, Department of Housing and Community Development. The building shall be delivered with an applied insignia; in compliance with all State regulations. The local building authority shall provide site inspections for the underground mechanical piping and final connections, footings, and access issues outside the restroom footprint. Restroom building subcontractor shall also furnish 5-year warranty, certifications for the concrete slab specification compliance, and maintenance manuals for the building and components.

BB. Turnover items

Six (6) tiles of each type used in the restroom. One (1) gallon of factory paint for each color and type used in the interior and exterior of the restroom. All supplied key to doors and cabinets.

CC. Payment

Payment for PRE-FABRICATED RESTROOM BUILDING shall be on a lump-sum basis and shall include full compensation for furnishing all design, coordination, labor, materials, delivery, tools, equipment, and incidentals for doing all work involved for all the items specified herein and in Subsection 300-1.4, "Payment," of the Standard Specifications and no additional compensation shall be allowed.

END OF SECTION

APPENDICES

APPENDIX A
LOCATION MAP

John F. Kennedy Veterans Memorial Park 15115 Indian St, Moreno Valley, CA 92553

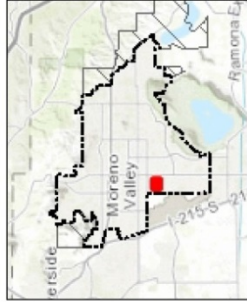
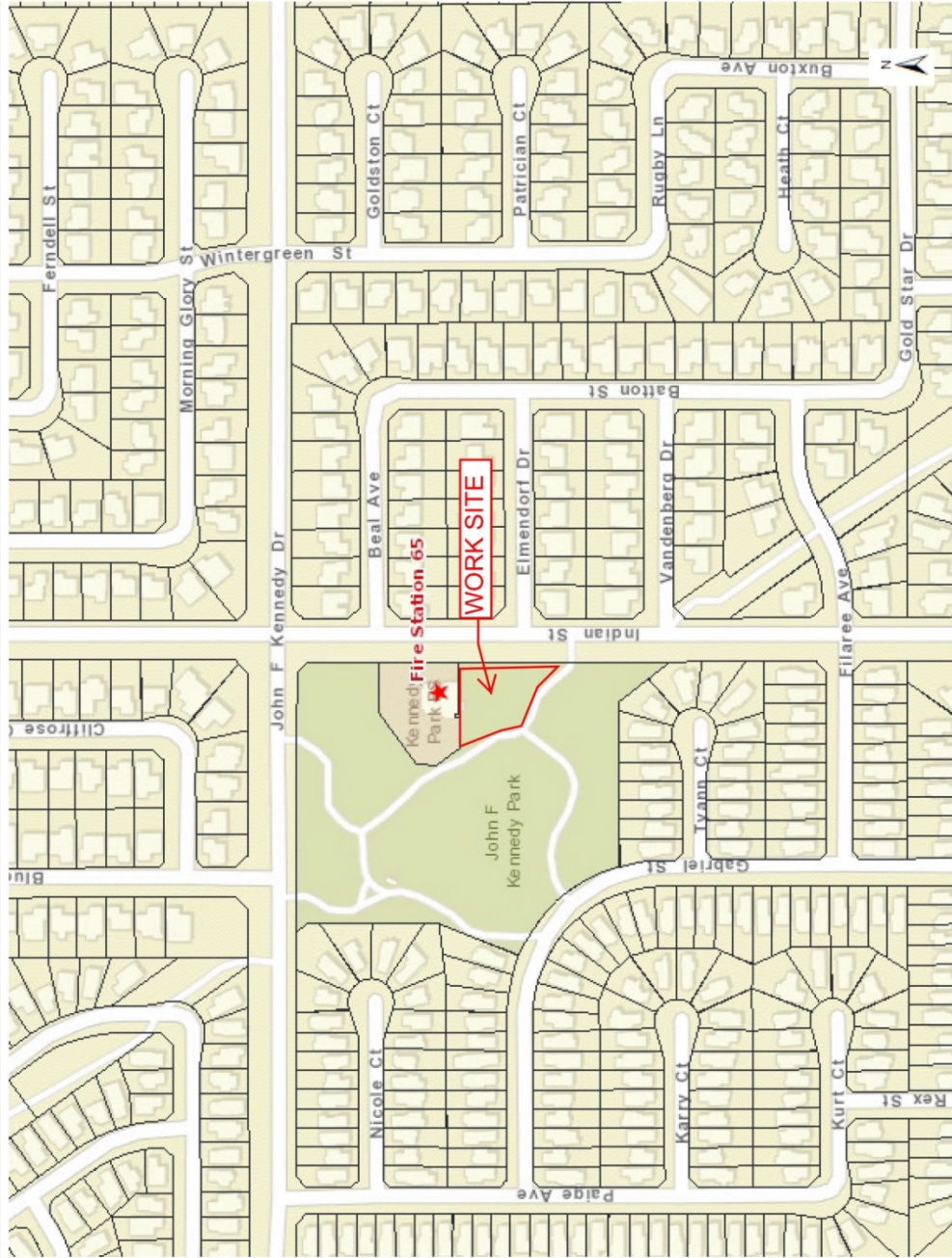

- Legend**
- Public Facilities
 - Public Facilities
 - Fire Stations
 - Parcels
 - City Boundary
 - Sphere of Influence

Notes

DISCLAIMER: The information shown on this map was compiled from the City of Moreno Valley GIS and Riverside County GIS. The land base and facility information on this map is for display purposes only and should not be relied upon without independent verification as to its accuracy. Riverside County and City of Moreno Valley will not be held responsible for any claims, losses or damages resulting from the use of this map.

631.0 315.48 631.0 Feet

WGS_1984_Web_Mercator_Auxiliary_Sphere

Print Date: 8/22/2017

APPENDIX B
CITY STANDARD PLANS

Attachment: Special Provisions PCS HSG GR-JFK RENO (2845 : APPROVE AND EXECUTE AGREEMENT FOR THE INSTALLATION OF A

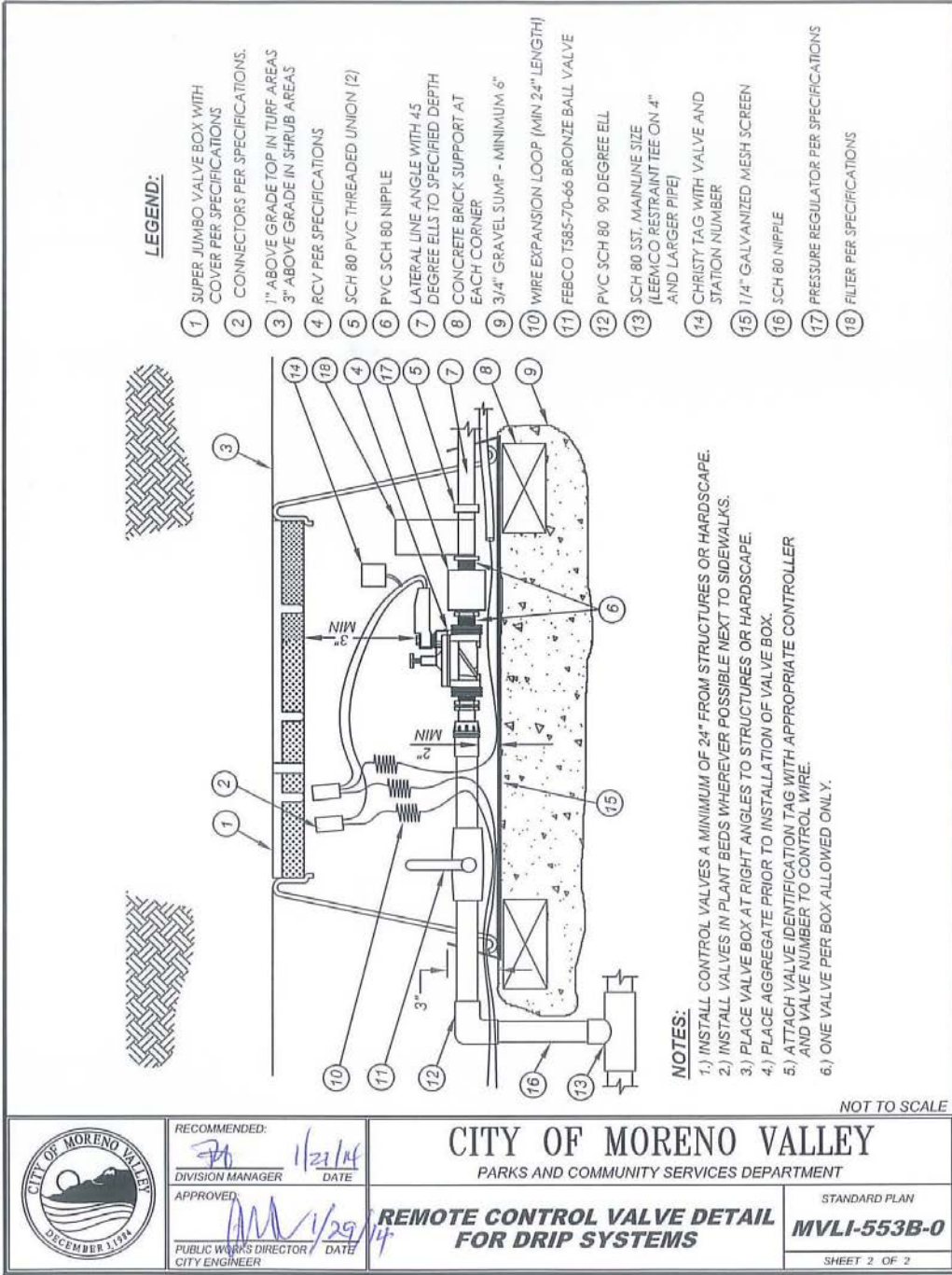

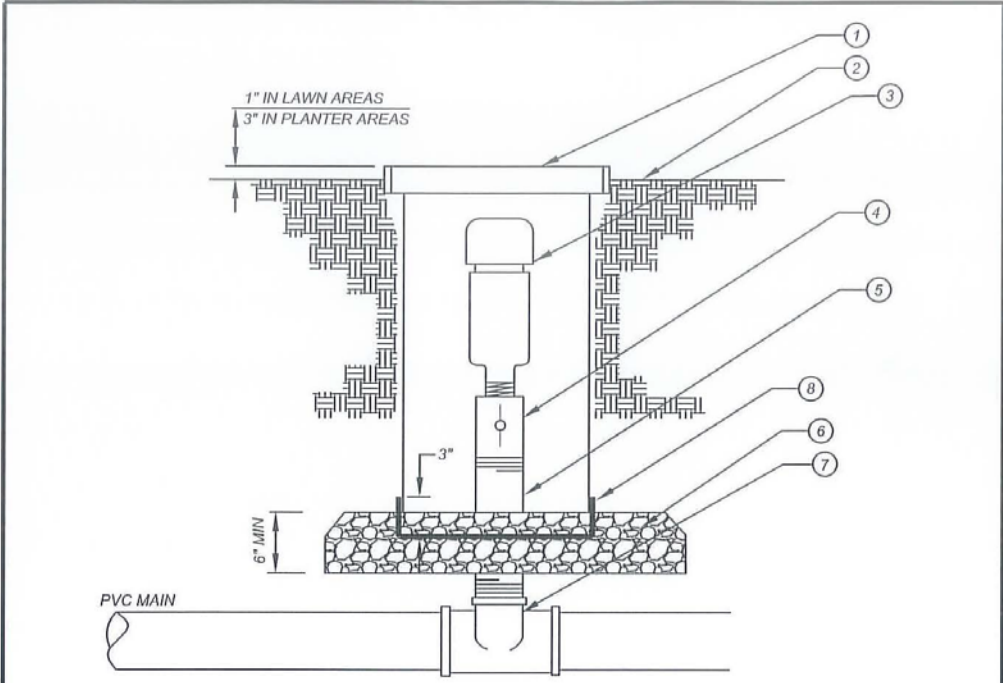

LEGEND:

- ① 10" ROUND VALVE BOX WITH LOCKING LID, "ARV" TO BE BRANDED ON LID. USE VALVE BOX EXTENSIONS AS NECESSARY TO REACH FINISH GRADE
- ② FINISH GRADE
- ③ 1" AIR/VACUUM RELIEF VALVE
- ④ 1" SCH 80 PVC BALL VALVE (FIPT X FIPT)
- ⑤ 1" SCH 80 PVC NIPPLE
- ⑥ 3/4" WASHED CRUSHED AGGREGATE BASE
- ⑦ SCH 80 PVC TEE (S x S x T) OR 90° ELL (S x T)
- ⑧ 1/4" GALVANIZED MESH WIRE

NOTES:

- 1) PLACE AGGREGATE PRIOR TO INSTALLATION OF BOX.

NOT TO SCALE

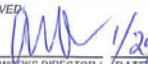
| | | | |
|---|---|---|-------------------------------------|
|  | RECOMMENDED: <i>FD</i> 1/21/14 DIVISION MANAGER DATE | CITY OF MORENO VALLEY PARKS AND COMMUNITY SERVICES DEPARTMENT | STANDARD PLAN MVLI-555B-0 |
| | APPROVED:  1/29/14 PUBLIC WORKS DIRECTOR / DATE CITY ENGINEER | AIR VACUUM RELIEF VALVE | SHEET 2 OF 2 |
| | CITY OF MORENO VALLEY DECEMBER 3, 1994 | | SHEET 2 OF 2 |

Attachment: Special Provisions PCS HSG GR-JFK RENO (2845 : APPROVE AND EXECUTE AGREEMENT FOR THE INSTALLATION OF A

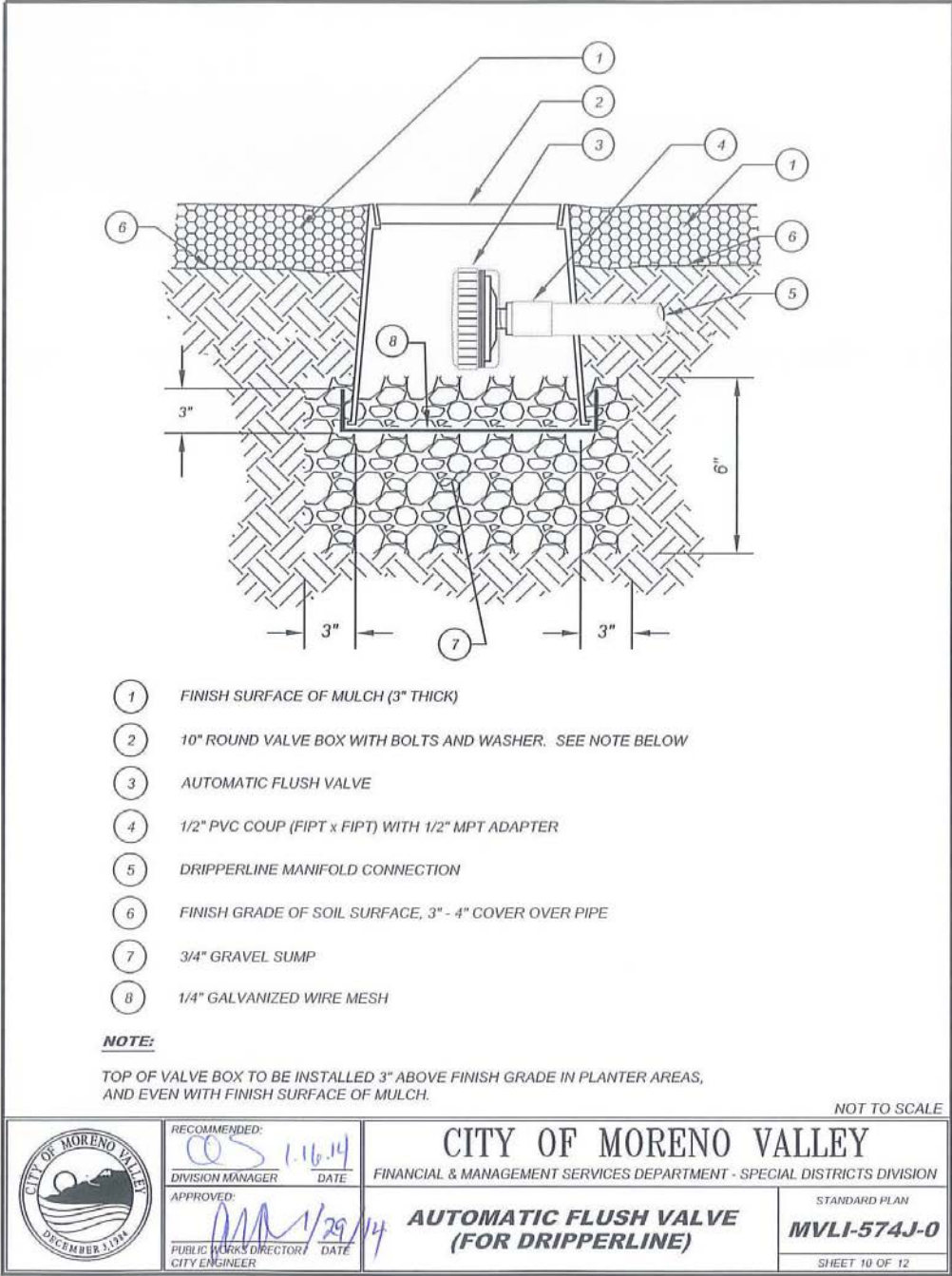

Attachment: Special Provisions PCS HSG GR-JFK RENO (2845 : APPROVE AND EXECUTE AGREEMENT FOR THE INSTALLATION OF A

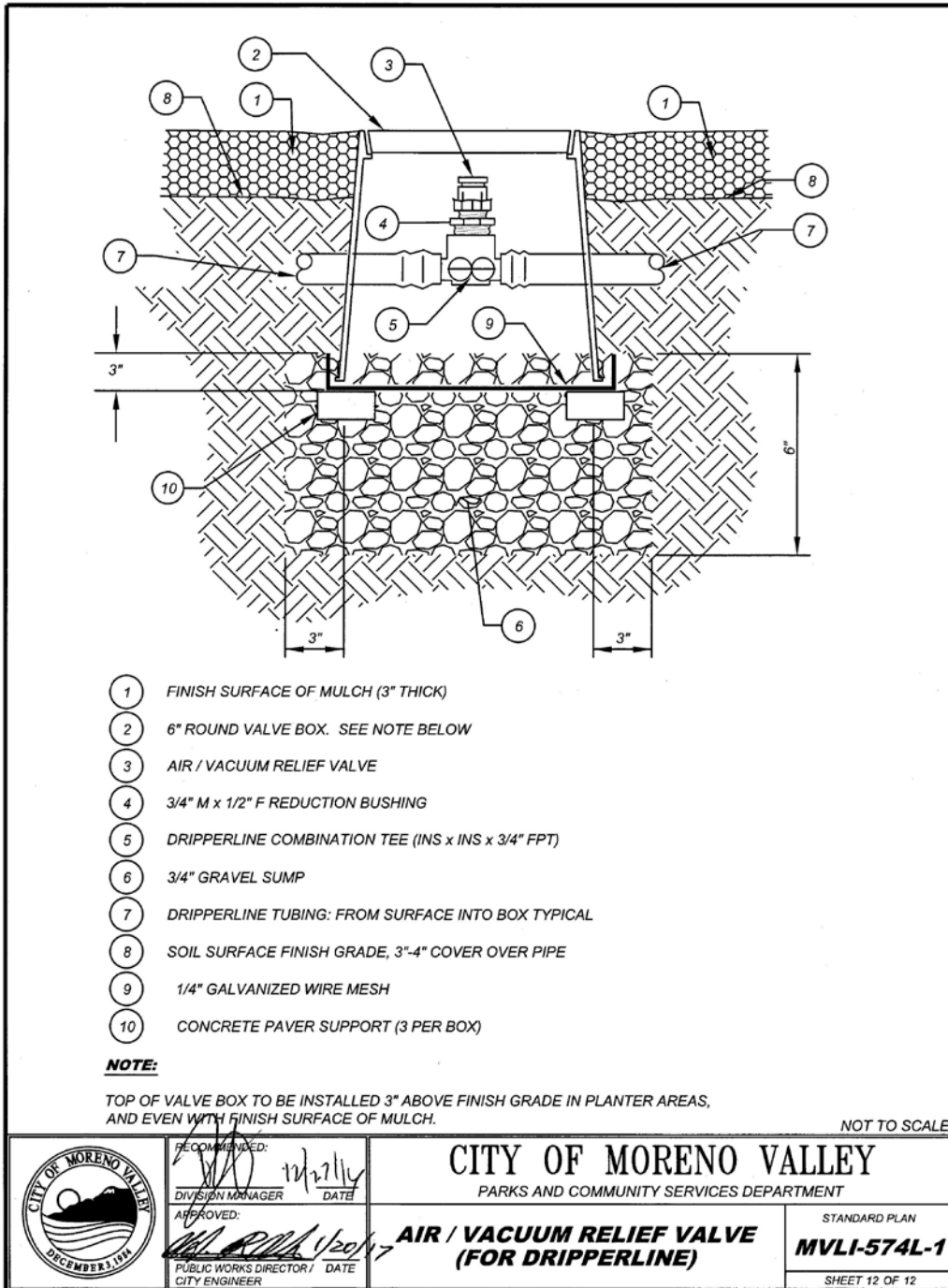

- 1 FINISH SURFACE OF MULCH (3" THICK)
- 2 6" ROUND VALVE BOX. SEE NOTE BELOW
- 3 AIR / VACUUM RELIEF VALVE
- 4 3/4" M x 1/2" F REDUCTION BUSHING
- 5 DRIPPERLINE COMBINATION TEE (INS x INS x 3/4" FPT)
- 6 3/4" GRAVEL SUMP
- 7 DRIPPERLINE TUBING: FROM SURFACE INTO BOX TYPICAL
- 8 SOIL SURFACE FINISH GRADE, 3"-4" COVER OVER PIPE
- 9 1/4" GALVANIZED WIRE MESH
- 10 CONCRETE PAVER SUPPORT (3 PER BOX)

NOTE:
TOP OF VALVE BOX TO BE INSTALLED 3" ABOVE FINISH GRADE IN PLANTER AREAS,
AND EVEN WITH FINISH SURFACE OF MULCH.

NOT TO SCALE

| | | | | |
|---|--|---|--------------------|----------------|
|  | RECOMMENDED:  DIVISION MANAGER DATE | CITY OF MORENO VALLEY PARKS AND COMMUNITY SERVICES DEPARTMENT | STANDARD PLAN | |
| | APPROVED:  PUBLIC WORKS DIRECTOR/ DATE CITY ENGINEER | AIR / VACUUM RELIEF VALVE (FOR DRIPPERLINE) | MVLI-574L-1 | SHEET 12 OF 12 |

LEGEND:

- ① JUMBO OR LARGER RECTANGULAR VALVE BOX PER SPECS
- ② STANDARD RECTANGULAR VALVE BOX PER SPECS
- ③ 10" DIA ROUND VALVE BOX
- ④ EDGE OF AREA, CURB, WALK OR WALL

VALVE NUMBER

PLAN

SAMPLE:
POTABLE WATER SYSTEM OF
CONTROLLER "A" REMOTE CONTROL
VALVE ON STA No 9

| | | IDENTIFICATION GUIDE | |
|----------------|-----------------|----------------------|-----------------------|
| DOMESTIC WATER | RECLAIMED WATER | CONTROLLER LEGEND | EQUIPMENT DESIGNATION |
| DIW | RW | A | ARV |
| DIW | RW | A | BS |
| DIW | RW | A | BV |
| DIW | RW | A | CCC |
| DIW | RW | A | DF |
| DIW | RW | A | FS |
| DIW | RW | A | FVA |
| DIW | RW | A | GR |
| DIW | RW | A | GV |
| DIW | RW | A | HB |
| DIW | RW | A | MS |
| DIW | RW | A | MV |
| DIW | RW | A | PB |
| DIW | RW | A | (STA NO.) |
| DIW | RW | A | QC |

| | | IDENTIFICATION GUIDE | |
|----------------|-----------------|----------------------|-----------------------|
| DOMESTIC WATER | RECLAIMED WATER | CONTROLLER LEGEND | EQUIPMENT DESIGNATION |
| DIW | RW | A | ARV |
| DIW | RW | A | BS |
| DIW | RW | A | BV |
| DIW | RW | A | CCC |
| DIW | RW | A | DF |
| DIW | RW | A | FS |
| DIW | RW | A | FVA |
| DIW | RW | A | GR |
| DIW | RW | A | GV |
| DIW | RW | A | HB |
| DIW | RW | A | MS |
| DIW | RW | A | MV |
| DIW | RW | A | PB |
| DIW | RW | A | (STA NO.) |
| DIW | RW | A | QC |

NOT TO SCALE

| | | |
|--|--|---|
| | RECOMMENDED: <i>[Signature]</i> 1/22/14 DIVISION MANAGER DATE | CITY OF MORENO VALLEY PARKS AND COMMUNITY SERVICES DEPARTMENT |
| | APPROVED: <i>[Signature]</i> 1/29/14 PUBLIC WORKS DIRECTOR / DATE CITY ENGINEER | BOX IDENTIFICATION |
| | | STANDARD PLAN MVLI-581-0 SHEET 1 OF 1 |

- NOTES:**
- A- VALVE BOXES SHALL BE LABELED BY HOT IRON BRANDING, 2" LETTERS/NUMBERS
 - B- CONTROL VALVES SHALL BE INSTALLED TO ALLOW ORDERLY ARRANGEMENT OF VALVE BOXES
 - C- WHERE POSSIBLE LOCATE VALVE ASSEMBLIES IN SHRUB OR GROUND COVER AREAS ONLY 12" FROM HARDSCAPE.
 - D- LOCATION OF VALVE ASSEMBLIES SHALL BE STAKED FOR APPROVAL BY LANDSCAPE ARCHITECT PRIOR TO INSTALLATION.
 - E- CENTER VALVE BOXES OVER VALVE ASSEMBLY TO FACILITATE ACCESS AND MAINTENANCE
 - F- SET VALVE BOXES AT EQUAL ELEVATIONS W/ TOPS AT 3" ABOVE FINISH GRADE IN SHRUB/ GROUND COVER AREAS.
 - G- VALVE BOXES SHALL BE SET PARALLEL TO EACH OTHER AND PERPENDICULAR TO EDGE OF AREA.
 - H- DO NOT DEFORM OR COLLAPSE VALVE BOX BY EXCESSIVE SOIL COMPACTION AROUND BOX.
 - I- SEE ALSO INDIVIDUAL VALVE INSTALLATION DETAILS.



Attachment: Special Provisions PCS HSG GR-JFK RENO (2845 : APPROVE AND EXECUTE AGREEMENT FOR THE INSTALLATION OF A

Attachment: Special Provisions PCS HSG GR-JFK RENO (2845 : APPROVE AND EXECUTE AGREEMENT FOR THE INSTALLATION OF A

DEPARTMENT OF PARKS AND COMMUNITY SERVICES GENERAL NOTES:

- A. ALL WORK SHALL BE DONE IN ACCORDANCE WITH THE MOST RECENT VERSIONS (AT TIME OF CONSTRUCTION) OF : THE CITY OF MORENO VALLEY PARK AND COMMUNITY SERVICES LANDSCAPE DEVELOPMENT GUIDELINES, SPECIFICATIONS, DRAWINGS, GREENBOOK SPECIFICATIONS FOR PUBLIC WORKS PROJECTS, AND THE CALIFORNIA BUILDING CODE.
- B. TURF AREAS SHALL HAVE A MAXIMUM DESIGN SLOPE OF 20% AND A MINIMUM DESIGN OF 1%.
- C. ALL CONCRETE SHALL ADHERE TO THE "GREENBOOK" FOR ITS SPECIFIC TYPE OF APPLICATION. MINIMUM REQUIREMENTS ARE 3250 PSI WITH NO SUBSTITUTES FOR PORTLAND CEMENT. COLOR AND FINISH SAMPLES SHALL BE PROVIDED TO THE PARKS AND COMMUNITY SERVICES PROJECT MANAGER FOR APPROVAL PRIOR TO INSTALLATION. PUMP MIXES SHALL BE 4000 PSI.
- D. CONTRACTOR / DEVELOPER SHALL PROVIDE A 12", #4 REINFORCED CONCRETE MOW STRIP BETWEEN TURF AND GROUND COVER AND A 12" CONCRETE MOW STRIP BETWEEN TURF AND WALLS, UNLESS SPECIFICALLY AUTHORIZED OTHERWISE BY PARKS AND COMMUNITY SERVICES.
- E. THE CONTRACTOR IS RESPONSIBLE FOR OBTAINING GRADING AND BUILDING PERMITS PRIOR TO COMMENCING CONSTRUCTION. PARKS AND COMMUNITY SERVICES WILL OBTAIN BUILDING PERMITS FOR CITY FUNDED PROJECTS.
- F. THE CONTRACTOR MUST NOTIFY THE PARKS AND COMMUNITY SERVICES PROJECT MANAGER AND THE BUILDING AND SAFETY DIVISION A MINIMUM OF TWO (2) WORKING DAYS (MONDAY - FRIDAY, EXCLUDING HOLIDAYS) PRIOR TO COMMENCING CONSTRUCTION AND / OR INSPECTION.
- G. ALL CONSTRUCTION WORK SHALL BE PERFORMED MONDAY THROUGH FRIDAY (EXCLUDING HOLIDAYS), BETWEEN THE HOURS OF 7 AM AND 4 PM. ANY EXCEPTIONS TO THIS SCHEDULE MUST BE APPROVED IN WRITING FROM PARKS AND COMMUNITY SERVICES.
- H. LANDSCAPE OR IRRIGATION CONTRACTOR SHALL VERIFY EXISTING WATER PRESSURE AT THE JOB SITE PRIOR TO INSTALLING LANDSCAPE IRRIGATION SYSTEM. A GAUGE THAT RECORDS MAINLINE PRESSURE AND FLOW IS REQUIRED FOR 24 HOUR / 7 DAY PERIOD.
- I. A MAINLINE TEST (IRRIGATION AND PORTABLE WATER) AT 150 PSI FOR 4 HOURS SHALL BE SCHEDULED WITH PARKS AND COMMUNITY SERVICES. IF WATER PRESSURE IS LESS THAN DESIGNED PRESSURE, THE CONTRACTOR WILL CONTACT THE ARCHITECT REGARDING THE FINDINGS AND WILL CEASE IRRIGATION WORK UNTIL A SOLUTION IS PROVIDED AND APPROVED IN WRITING BY THE PARKS AND COMMUNITY SERVICES PROJECT MANAGER. MAINLINE TESTS MUST HAVE ALL APPURTENANCES ATTACHED (VALVES, UNIONS, ETC.)
- J. THE CONTRACTOR IS RESPONSIBLE FOR INSTALLING AN IRRIGATION SYSTEM THAT PROVIDES COMPLETE COVERAGE TO PLANT MATERIAL IN A MATURE STAGE. IRRIGATION MODIFICATIONS MAY BE REQUIRED TO KEEP WATER OFF OF LIGHT FIXTURES, DRINKING FOUNTAINS, PLAY EQUIPMENT, PICNIC AREAS, STRUCTURES, FENCING, SIDEWALKS, ETC.
- K. AT THE CONCLUSION OF ROUGH GRADING, AGRONOMIC SOILS TESTING SHALL BE PROVIDED FOR THE PUBLIC LANDSCAPED AREA AND AREAS THAT ARE ADJACENT TO PUBLIC RIGHT-OF-WAY AND THE RESULTS APPROVED BY PARKS AND COMMUNITY SERVICES, PRIOR TO ANY LANDSCAPE INSTALLATION.
- L. A COMPREHENSIVE SOILS TEST IS REQUIRED PRIOR TO PLACING ANY CONCRETE (PCG OR AC) AND BACK FILLED TRENCHES. THIS WILL BE USED TO DETERMINE THE CONCRETE DESIGN AND NECESSITY OF ADDITIONAL BASE MATERIALS ABOVE THE DESIGN ON THE PLANS AND CITY STANDARDS. THE PLAN DESIGN AND CITY STANDARDS SHALL SET THE MINIMUM STANDARDS.
- M. ALL LOAD TICKETS OR RECEIPTS SHALL BE PROVIDED TO PARKS AND COMMUNITY SERVICES WITHIN 24 HOURS OF RECEIPT OF PRODUCT. COPIES OF LOAD TICKETS / RECEIPTS INCLUDE BUT ARE NOT LIMITED TO CONCRETE; SOIL AND LANDSCAPE PRODUCTS; PLANT MATERIAL; FENCING AND BUILDING MATERIALS.
- N. ALL 'SUBMITTALS' AND SHOP DRAWINGS SHALL BE PROVIDED TO PARKS AND COMMUNITY SERVICES WITHIN THE FIRST 30-DAYS OF THE AWARD OF CONTRACT.
- O. ALL MATERIALS SHALL BE AS SPECIFIED WITHIN THE PLANS AND SPECIFICATIONS. 'EQUALS OR SUBSTITUTIONS' WILL ONLY BE CONSIDERED WITHIN THE FIRST 30-DAYS AFTER THE AWARD OF CONTRACT. THE PARKS AND COMMUNITY SERVICES PROJECT MANAGER SHALL APPROVE IN WRITING ALL 'EQUALS OR SUBSTITUTIONS'. THE CONTRACTOR SHALL REPLACE AT THE CONTRACTOR'S COST ANY PRODUCT UTILIZED THAT HAS NOT BEEN APPROVED IN WRITING BY THE PARKS AND COMMUNITY SERVICES PROJECT MANAGER.
- P. THE CONTRACTOR SHALL COORDINATE WITH AND NOTIFY THE PARKS AND COMMUNITY SERVICES PROJECT MANAGER OF THE REQUIRED PRE-CONSTRUCTION MEETING TO BE HELD ON SITE.
- Q. THE CONTRACTOR OR DEVELOPER SHALL GUARANTEE ALL MATERIALS AND WORKMANSHIP FOR A PERIOD OF ONE (1) YEAR AFTER PARKS AND COMMUNITY SERVICES ACCEPTS THE SITE IMPROVEMENTS.
- R. THE CONTRACTOR OR DEVELOPER SHALL MAINTAIN ALL LANDSCAPING FOR A PERIOD OF ONE (1) YEAR AFTER THE PARKS AND COMMUNITY SERVICES HAS ACCEPTED ALL IMPROVEMENTS FOR MAINTENANCE WITHIN COMMUNITY SERVICES DISTRICTS. BOND'S SHALL BE REQUIRED IN THE AMOUNT TO COVER THE WORK. CITY FUNDED PROJECTS ARE EXEMPT FROM THIS REQUIREMENT.

NOT TO SCALE

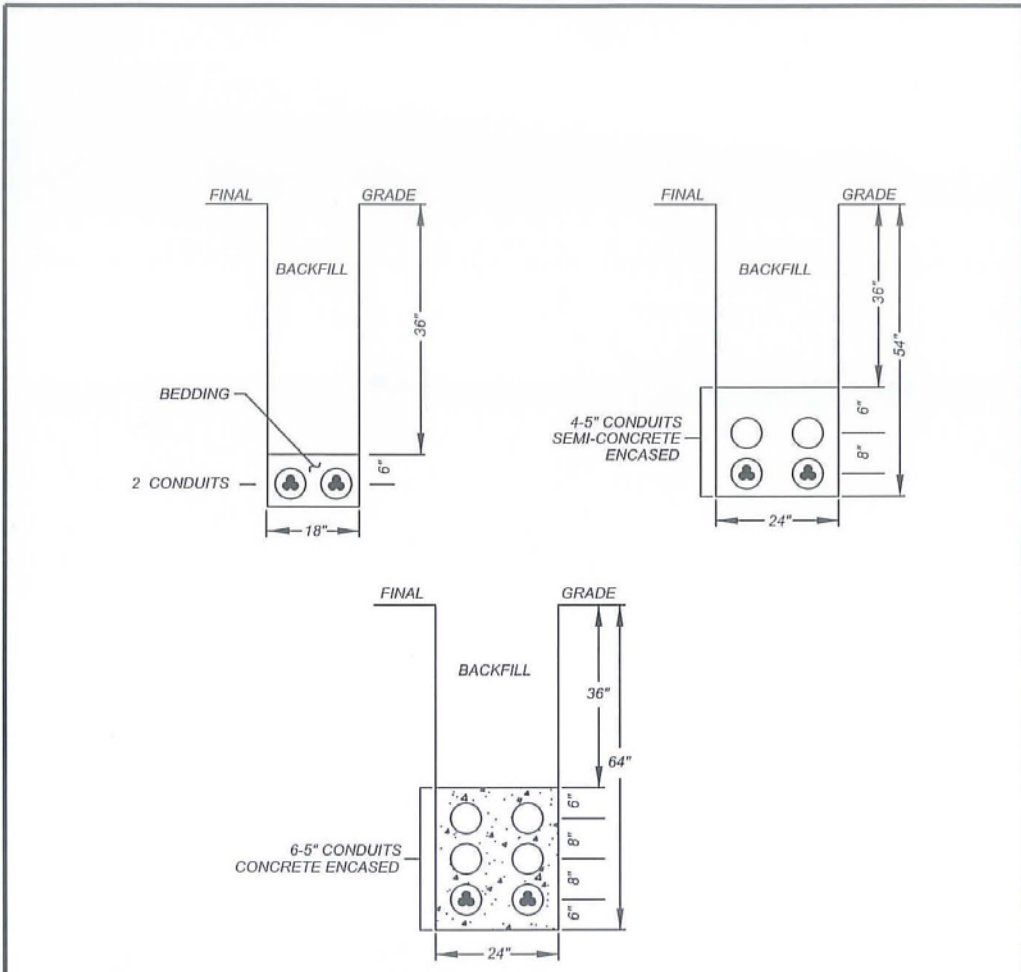

| | | | | |
|---|---|-----------------|---|------------------------------------|
|  | RECOMMENDED:  | 1/21/14 DATE | CITY OF MORENO VALLEY PARKS AND COMMUNITY SERVICES DEPARTMENT | STANDARD PLAN MVGF-600-0 |
| | APPROVED:  | 1/29/14 DATE | | |



NOTES:

- 1.) BEDDING MATERIAL SHALL BE CLEAN SAND OR PEA GRAVEL. OTHERWISE, NATIVE MATERIALS MAY BE USED PROVIDED THEY MEET PUBLIC WORKS CONSTRUCTION (GREEN BOOK) STANDARDS PER SUBSECTION 306.1.2.1 AND MUST HAVE A SAND EQUIVALENT OF NOT LESS THAN 30 OR HAVING A COEFFICIENT OF PERMEABILITY GREATER THAN 1.4 INCHES/HR.
- 2.) CONDUITS ARE DB, EB, OR SCH 40 DEPENDING ON APPLICATION PER PLAN.
- 3.) CONCRETE SHALL BE TWO SACK ENCASEMENT.

NOT TO SCALE

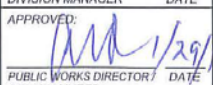
| | | | |
|---|---|---|-------------------------------------|
|  | RECOMMENDED:  1/23/14 DIVISION MANAGER DATE | CITY OF MORENO VALLEY PARKS AND COMMUNITY SERVICES DEPARTMENT | |
| | APPROVED:  1/29/14 PUBLIC WORKS DIRECTOR / DATE CITY ENGINEER | TRENCH DETAILS FOR CONDUIT INSTALLATIONS IN PARKS | STANDARD PLAN MVGF-618B-0 |
| | SHEET 2 OF 2 | | |

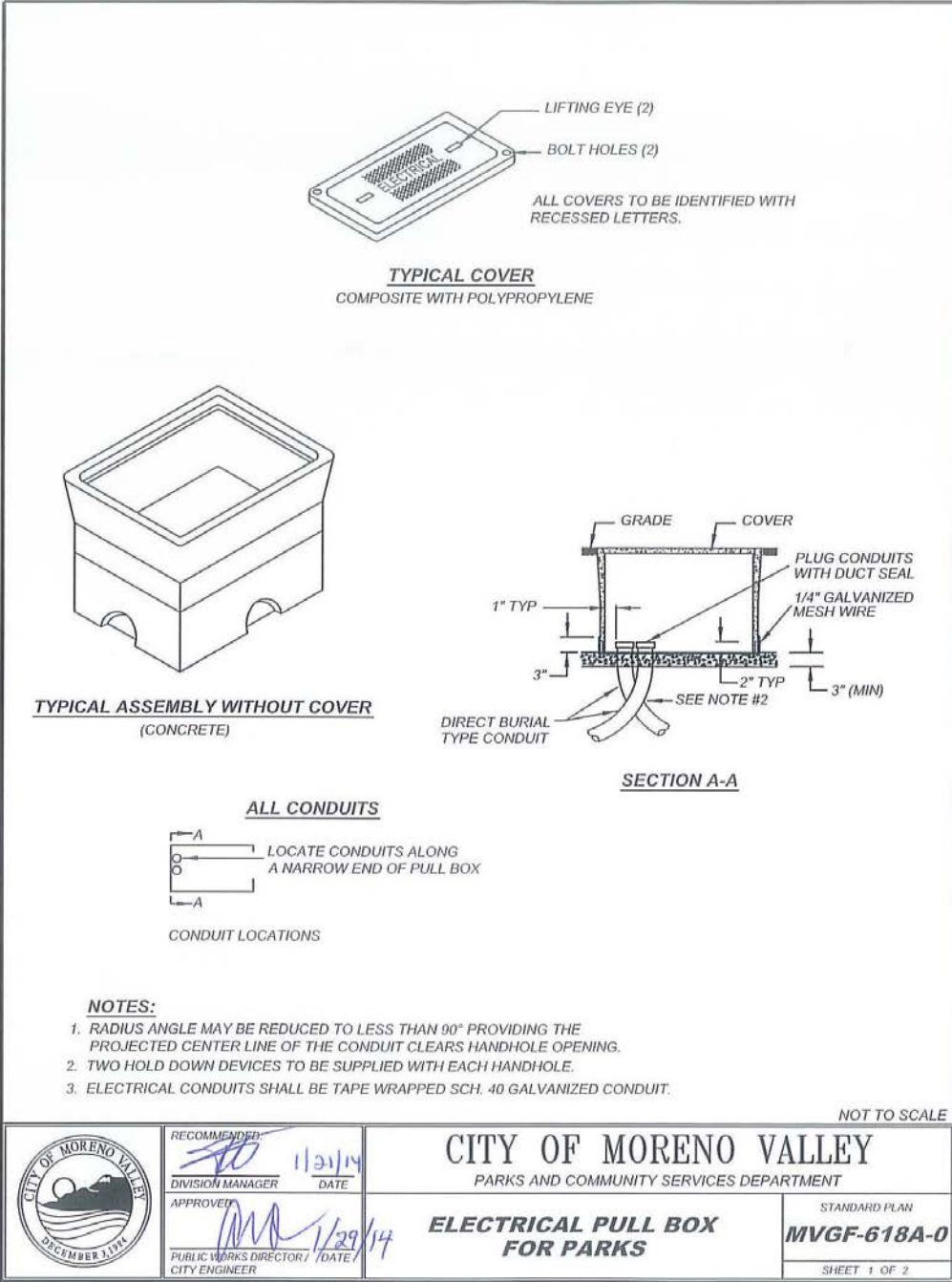

APPENDIX C
CERTIFIED PAYROLL FORM

Attachment: Special Provisions PCS HSG GR-JFK RENO (2845 : APPROVE AND EXECUTE AGREEMENT FOR THE INSTALLATION OF A

NOTICE TO PUBLIC ENTITY

For Privacy Considerations

Fold back along dotted line prior to copying for release to general public (private persons).

(Paper Size then 8-1/2 x 11 inches)



I, _____, the undersigned, am the
(Name – print)

_____ with the authority to act for and on behalf of
(Position in business)

_____, certify under penalty of perjury
(Name of business and/or contractor)

that the records or copies thereof submitted and consisting of _____
(Description, number of pages)

are the originals or true, full, and correct copies of the originals which depict the payroll record(s)
of the actual disbursements by way of cash, check, or whatever form to the individual or
individuals named.

Date: _____ Signature: _____

A public entity may require a stricter and/or more extensive form of certification.

Attachment: Special Provisions PCS HSG GR-JFK RENO (2845 : APPROVE AND EXECUTE AGREEMENT FOR THE INSTALLATION OF A

APPENDIX D
SOLID WASTE DISPOSAL AND RECYCLING REPORTS

Attachment: Special Provisions PCS HSG GR-JFK RENO (2845 : APPROVE AND EXECUTE AGREEMENT FOR THE INSTALLATION OF A

City of Moreno Valley
SOLID WASTE DISPOSAL AND RECYCLING REPORT - INSTRUCTIONS

Section 1: To be completed by the contractor

Project Name: Give a brief description of the project.

Type of Work: Enter a general work description, e.g. "AC Grinding" Widening, Reconstruction, Overlay

Ongoing Report: Checking this box means this is a report for a continuing project. More monthly reports will follow.

Final Report: Checking this box means this is the last report before contract acceptance.

Project Number: Enter Project Number (reporter must enter the following information data and address project separate reports received for each month).

Company Information: Contractor Name, Phone Number, Fax Number, Street Address, City, State and Zip

Contractor Certification: I certify under penalty of perjury that the information provided in this form is complete and accurate.

Contractor should verify the data entered on this form, then sign the report and print your name, title, and date.

Return this report to the project engineer by the 10th of the following month or within 15 days of final work.

Section 2: To be completed by the contractor

To count towards diversion, "solid waste" is defined as including any solid waste which would normally be disposed of at a disposal facility (PRC Section 41781 (b))

NAME AND LOCATION OF RECYCLING OR DISPOSAL FACILITY (or enter "reused" for materials generated and reused on this job)

Each address should be checked as either landfill or recycler. When using a recycling facility that exists inside a landfill, check recycler and do not check landfill. When the solid waste is generated and reused on the job, the word "Reused" should be entered in place of the address.

TYPE OF MATERIAL Please enter a number for each activity one per line:

1 = Source-Separated Materials Recycling; 2 = On-Site Reuse; 3 = Mixed Debris Recycling; 4 = Reuse of Salvageable Items; 5 = Disposal at Landfill 6 = Transfer Station; 7 = Other [Describe the activity when "Other" is selected]²

AMOUNT TAKEN TO LANDFILL (Tons): Enter the amount of any solid waste, in tons, that is generated on this project and taken to a landfill and attach copies of weight tickets.

AMOUNT DIVERTED FROM LANDFILLS TO A RECYCLING FACILITY (Tons): Enter the amount of any solid waste, in tons, that is generated on this project and taken to a recycling facility and attach copies of weight tickets.

Solid waste from this job that is used in other projects, given to other agencies (county, city etc.) or given to private individuals for reuse will be entered as taken to a recycling facility. In this case, check the activity as "Other" and describe who gets the solid waste in the row for other activity. (e.g. given to county, city or developer)

AMOUNT GENERATED AND THEN REUSED ON THIS JOB (Tons): Enter the amount of any solid waste, in tons, that is generated on this project and reused.

TOTAL (TONS) Total amount taken to landfill + amount recycled + amount reused.

% DIVERTED Total recycled + total reused + total tons x 100

These conversion factors may be found at the California Integrated Waste Management Board's (CIWMB) web site at: <http://www.ciwmb.ca.gov/LGLibrary/DSG/Appendix.htm#Conversion>

Section 3: To be completed by the project engineer

I have reviewed the information submitted in this report for completeness.

Project engineer please review the report. If the form is complete, sign and print your name, phone number, and date. Discuss and resolve with the contractor any deficiency on the form.

The project engineer shall submit the completed form to the appropriate City representative by the 20th of the following month or within 30 days of final work.

City of Moreno Valley
PUBLIC IMPROVEMENT
DAILY/WEEKLY SOLID WASTE RECYCLING REPORT
Project Name: (Insert Name)
Project No.: (Insert Number)

Month/Year: _____

Page ____ of ____

Type of Material: _____

Contractor/Subcontractor: _____

| Date | Name & Location of Recycling Facility | Tons |
|-------------------|---------------------------------------|------|
| Monday | | |
| Tuesday | | |
| Wednesday | | |
| Thursday | | |
| Friday | | |
| Saturday | | |
| Week Total | | |

City of Moreno Valley
Public Improvement
DAILY SOLID WASTE RECYCLING REPORT

Project Name: (Insert Name)

Project No.: (Insert Number)

Date: _____

Contractor: _____

Subcontractor: _____

Month/Year: _____

| Material | To Landfill (Tons) | Recycled (Tons) | Resused (Tons) | Disposed (tons) | Total Quantity Generated (Tons) | Facility Used/Destination |
|---|--------------------|-----------------|----------------|-----------------|---------------------------------|--|
| | A | B | C | A+B | A+B+C | |
| | Weight | Weight | Weight | Weight | Weight | |
| Example: Dirt | 5 tons | 5 tons | 9.5 tons | 10 tons | 24.5 tons | Recycle - Azusa Land Reclamation Reuse - On Job Site for Grading Dispose - Puente Hills Landfill |
| Asphalt Concrete | | | | | | |
| Brick | | | | | | |
| Building Materials (ceiling tile, fixtures, etc.) | | | | | | |
| Cardboard, paper | | | | | | |
| Carpet/Carpet Padding | | | | | | |
| Concrete (PCC) | | | | | | |
| Dirt | | | | | | |
| Glass | | | | | | |
| Green Waste | | | | | | |
| Gypsum/Dry Wall | | | | | | |
| Metals | | | | | | |
| Mixed C&D (commingled, recyclable) | | | | | | |
| Plastic | | | | | | |
| Rock | | | | | | |
| Roofing | | | | | | |
| Tile (ceramic) | | | | | | |
| Wood (lumber, doors, etc.) | | | | | | |
| Refuse | | NA | NA | NA | | |
| Other | | | | | | |
| Totals | | | | | | |

Use your daily weight receipts to fill in the table below and submit receipts attached with this form.

Total Recycled _____ + Total Reused _____ = _____ ÷ Total Quantity Generated _____ x 100 = _____ %

Attachment: Special Provisions PCS HSG GR-JFK RENO (2845 : APPROVE AND EXECUTE AGREEMENT FOR THE INSTALLATION OF A

City of Moreno Valley
Public Improvement
DAILYWEEKLY SOLID WASTE RECYCLING REPORT

Use your daily weight receipts to fill in the table below and submit receipts attached with this form.

Project Name:

Contractor:

Project No.

Subcontractor:

Month/Year:

| Material | Recycled | | Resused | | Disposed (tons) | Total Quantity Generated | Facility Used/Destination |
|---|----------|--------|-------------------|----------|-----------------|--------------------------|--|
| | Volume | Weight | Volume | Weight | | | |
| Example: Dirt 10yd ³ = 18,900lbs | NA | 5 tons | 10yd ³ | 9.5 tons | 10 tons | 24.5 tons | Recycle - Azusa Land Reclamation Reuse - on job site for grading Dispose - Puente Hills Landfill |
| Asphalt 1yd ³ = 1,380lbs | | | | | | | |
| Brick 1yd ³ = 3,024lbs | | | | | | | |
| Building Materials (ceiling tile, fixtures, etc.) | | | | | | | |
| Cardboard, paper 1yd ³ = 100lbs | | | | | | | |
| Carpet/Carpet Padding 1yd ³ = 84.4lbs | | | | | | | |
| Concrete 1yd ³ = 1,855lbs | | | | | | | |
| Dirt 10yd ³ = 18,900lbs | | | | | | | |
| Glass 1yd ³ = 2,160lbs | | | | | | | |
| Green Waste 40yd ³ = 4,320lbs | | | | | | | |
| Gypsum/Dry Wall 1yd ³ = 3,834lbs | | | | | | | |
| Metals 1yd ³ = 906lbs | | | | | | | |
| Mixed C&D (commingled, recyclable) | | | | | | | |
| Plastic 1yd ³ = 22.55lbs | | | | | | | |
| Rock 1yd ³ = 2,570lbs | | | | | | | |
| Roofing 1yd ³ = 418.5lbs | | | | | | | |
| Tile (ceramic) 1yd ³ = 1,214lbs | | | | | | | |
| Wood (lumber, doors, etc.) 1yd ³ = 329.5lbs | | | | | | | |
| Refuse | NA | NA | NA | NA | | | |
| Other | | | | | | | |
| Totals | | | | | | | |

Total Recycled _____ + Total Reused _____ = _____ ÷ Total Quantity Generated _____ x 100 = _____ %

Attachment: Special Provisions PCS HSG GR-JFK RENO (2845 : APPROVE AND EXECUTE AGREEMENT FOR THE INSTALLATION OF A

APPENDIX E

DIG ALERT DELINEATION FOR UNDERGROUND SERVICE MARKINGS

MEMBERS! Be prepared...DigAlert Ticket format changes become effective Nov 1st, 2017

Also effective Nov 1st, 2017 Grid Notifications are no longer supported. Submit shapefiles today.

(/)

Contact 811 Before You Dig

Southern California's free and easy solution
for safe excavation

California Law

View CA Government Code 4216 (/calaw-full-2017)

California State Law Says, You Must Contact DigAlert Before You Dig!

Failure to do so can result in fines up to fifty thousand dollars and you could be charged with the repair costs of damaged underground facility. Why risk it? Contact DigAlert before you dig and they will notify all of its members having underground facilities within the delineated area.

Important changes & highlights effective Jan 1st 2017

- Delineation of the proposed excavation site is now mandatory. If the delineation could be misinterpreted as a traffic or pedestrian control, the excavator shall use pink markings and notify the center the delineation is in pink. (4216.2(a) & 4216 Definitions (d))

<https://www.digalert.org/calaw>

08/23/2017

APPENDICES
00800-165

Packet Pg. 424

- Members can, at their own discretion, choose not to locate and field mark until the area to be excavated has been delineated. (4216.2(a))
- Contact DigAlert at least two (2) working days NOT including the date of notification (4216.2(b)) prior to digging.
- Any temporary marking placed at the planned excavation location shall be clearly seen, functional, and considerate to surface aesthetics and the local community. An excavator shall check if any local ordinances apply to the placement of temporary markings. (4216.2(d))
- Working day is defined as a weekday (M - F) from 7:00 am to 5 :00 pm, except for federal and state holidays as defined in Section 19853, or as otherwise posted on the Internet Web Site of the regional notification center. (4216 Definitions (v))
- Excavations shall not begin until the excavator receives a response from all known members within the delineated boundaries. (4216.2(g))
- If a ticket obtained by an excavator expires but work is ongoing, the excavator shall call into the regional notification center and get a new ticket and wait a minimum of two working days, not including the date of call in, before restarting excavation. All excavation shall cease during the waiting period.(4216.2(i))
- An operator shall indicate with an "A" inside a circle the presence of any abandoned subsurface installations, if known, within the delineated area. The markings are to make an excavator aware that there are abandoned subsurface installations within that delineated work area.(4216.3(a)(1) (A)(iii)(C))
- If the field marks are no longer reasonably visible, an excavator shall renotify the regional notification center with a request for remarks that can be for all or a portion of the excavation. Excavation shall cease in the area to be remarked. If the delineation markings are no longer reasonably visible, the excavator shall redelineate the area to be remarked. If remarks are requested, the operator shall have two working days, not including the date of request, to remark the subsurface installation. If the area to be remarked is not the full extent of the original excavation, the excavator shall delineate the portion to be remarked and provide a description of the area requested to be remarked on the ticket. The excavator shall provide a description for the area to be remarked that falls within the area of the original location request. (42216.3(b))
- The Law requires you to hand expose to the point of no conflict 24" on either side of the underground facility, so you know its exact location before using power equipment. (4216.4(a)(1))
- Your permit for digging will not be valid without a ticket number. (4216.9(a))
- The California Underground Facilities Safe Excavation Board is hereby created under, and shall be assisted by the staff of, the Office of the State Fire Marshal. (4216.12(a))

Important changes effective Jan 1st 2018

- Members may supply an electronic positive response through the regional notification center before the legal excavation start date and time. The regional notification center shall make those responses available to the excavator. (4216.3 (b))

Important changes effective July 1st 2018

- The board shall investigate possible violations of this article. (4216.19(a))

View the New 2017 California Law, Government Code 4216 (/calaw-full-2017)

But I have an emergency and I need to dig now!

California law requires that you call two (2) working days, not including the date of notification, before your planned excavation. However, if you are digging because of an EMERGENCY, you are not required by law to call. You should still consider calling in order to prevent damaging any other underground lines near your EMERGENCY dig site. An EMERGENCY situation does not relieve you of financial responsibilities for damaging underground facilities.

However keep in mind that under 4216 Definitions (f)(1) states...

"Emergency" means a sudden, unexpected occurrence, involving a clear and imminent danger, demanding immediate action to prevent or mitigate loss of, or damage to, life, health, property, or essential public services.

(2) "Unexpected occurrence" includes, but is not limited to, a fire, flood, earthquake or other soil or geologic movement, riot, accident, damage to a subsurface installation requiring immediate repair, or sabotage.

Digging without a DigAlert is just simply dangerous, not to mention illegal!

You can damage a basic telephone cable and disrupt service to a home or you may cut a fiber optic cable carrying millions of calls and expose your company to costly repairs. Plus there is the real possibility of an explosion from hitting a gas line or an electrocution from an electric line! Not only is expensive equipment ruined, but lives are put at risk.

Learn More

[About DigAlert \(/about\)](#)

[Typical Projects \(/safe-digging#typical_projects\)](#)

[F.A.Q.s \(/faqs\)](#)

[Membership with USA/SC \(/members\)](#)

Digging Resources

[CA State Law \(/calaw\)](#)

[CGA Best Practices \(/pdfs/bestpractices.pdf\)](#)

[Delineation Guide \(/delineation\)](#)

[APWA Color Codes \(/delineation#apwa_color_codes\)](#)

[Emergency Procedure \(/emergency-dig-process\)](#)

Network with us!



<https://www.facebook.com/digalert>



<https://twitter.com/@digalert>



https://www.instagram.com/digalert_official/



[https://www.linkedin.com/company/underground-service-alert-of-southern-](https://www.linkedin.com/company/underground-service-alert-of-southern-california-digalert-?report.success=KJ_KkFGTDCfMt-A7wV3Fn9Yvgwr02Kd6AZHGx4bQCDiP6-2rfP2oxyVoEQiPrcAQ7Bf)

[california-digalert-?report.success=KJ_KkFGTDCfMt-A7wV3Fn9Yvgwr02Kd6AZHGx4bQCDiP6-2rfP2oxyVoEQiPrcAQ7Bf](https://www.linkedin.com/company/underground-service-alert-of-southern-california-digalert-?report.success=KJ_KkFGTDCfMt-A7wV3Fn9Yvgwr02Kd6AZHGx4bQCDiP6-2rfP2oxyVoEQiPrcAQ7Bf)



© 2017

Underground Service Alert of Southern California.

All rights reserved.

[Terms of Service / Privacy Policy \(/tos\)](#)



How to Delineate a Prospective Excavation Site

This marking guide provides for uniform marking of the area to be excavated with white paint in paved surfaces, or in unpaved areas with other suitable markings such as stakes or flags.

White Paint Marking

In the case of a single excavation of known dimensions and location, delineate the exact area to be excavated with white paint through the use of dots or dashes, or a continuous solid line. Limit the size of each dash to 6 inches in length and 1 inch in width, with interval spacing not less than 48 inches between each dash. When using a solid line, limit its width to 1 inch. In either case, excavators must insure that their white paint marks cannot be misinterpreted as a traffic or pedestrian control.

In the case of numerous excavations or one long, continuous excavation, mark the center line of the excavation with arrows showing the direction of the excavation. Mark lateral excavation with an arrow

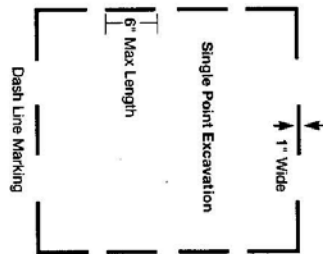
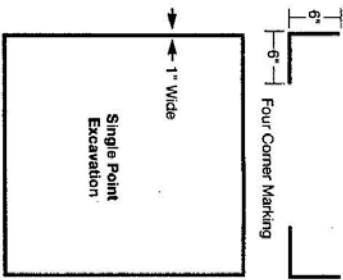

showing direction from the center line with an additional mark at the curb of property line. Limit the size of each arrow to 6 inches in length and 1 inch in width, with interval spacing not less than 48 inches between each arrow. When calling the regional notification center for locating, give the width of the excavation in number of feet either side of the center line of lateral marks.

The marked area of excavation should be identified by the name, initials or logo, in white paint, of the company planning to conduct the excavation.

Delineate the area to be excavated before calling the regional notification center. If this is impractical due to permit requirements or other restrictions, notify the center of the exact date and time the excavation will be delineated. This will assist the operators of subsurface installations in scheduling their field marking.

All excavators are reminded that premarking is a requirement of the California Code of Regulations, Section 4216 and 4217. Failure to premark when practical can jeopardize your permit, or result in civil penalties. If premarking is not practical, the excavator shall contact the regional notification center to advise the operators that the excavator shall identify the area to be excavated in another manner sufficient to enable the operator to determine the exact area of the excavation to be field marked.

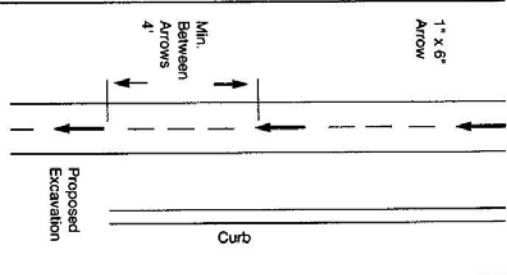

Trench or Continuous Excavation

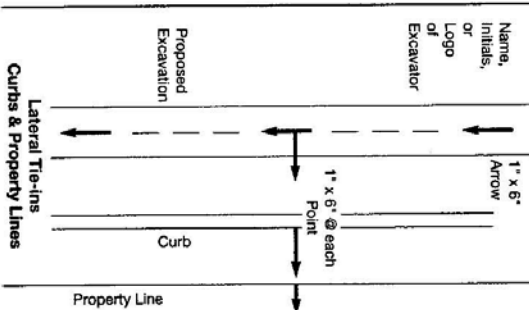

APPENDIX F
RED IMPORTED FIRE ANT COOPERATIVE AGREEMENT

Attachment: Special Provisions PCS HSG GR-JFK RENO (2845 : APPROVE AND EXECUTE AGREEMENT FOR THE INSTALLATION OF A

RED IMPORTED FIRE ANTS (RIFA)

The City of Moreno Valley has areas of infestation of red imported fire ant colonies and has quarantine areas. Movement of earth within and from the quarantine areas is restricted to inspection and possible treatment. RIFA have been found to nest under cracked pavement, sidewalks, water meter boxes, pull boxes, and traffic signal cabinets along with other utilities within the right-of-way.

The Contractor shall notify the California Department of Food & Agriculture, Jose Reyes (760) 776-8208, or Riverside County Agricultural Commissioner before excavating or moving any earth or making a disturbance to the soil. The Contractor shall fill out and send a cooperative Red Imported Fire Ant Project Agreement to the California Department of Food and Agriculture, 73-710 Fred Waring Drive, Suite 220, Palm Desert, CA 92260.

Should the Contractor be delayed, and such delay could not have been reasonably foreseen or prevented by the Contractor, the Contractor shall be entitled only to an equivalent extension of time for the completion of the Contract, and shall not be entitled to damages due to downtime and idled equipment or additional payments over and above the agreed upon unit prices.

Full compensation for compliance with the preceding requirements shall be considered as being included in the various Contract items in the bid schedule and no additional compensation will be allowed therefore, except if the RIFA are found. A Contract Change Order will be issued for the eradication of the RIFA.

Bid Results for Project Restroom Improvements - John F. Kennedy Veterans Memorial Park (2018-008)

Issued on 10/31/2017
 Bid Due on November 21, 2017 4:00 PM (Pacific)
 Exported on 11/27/2017
 Line Totals (Unit Price * Quantity)

| Item # | Section | Description | Unit | Quantity | KASA Construction, Inc. | | Horizons Construction Inc. | | Epsilon Engineering | | AToM Eng Const, Inc. | |
|--------|-----------------|---|------|----------|-------------------------|-------------|----------------------------|-------------|---------------------|--------------|----------------------|-------------|
| | | | | | Unit Price | Line Total | Unit Price | Line Total | Unit Price | Line Total | Unit Price | Line Total |
| 1 | MOBILIZATION | MOBILIZATION AND DEMOBILIZATION | LS | 1 | \$57,800.00 | \$57,800.00 | \$24,600.00 | \$24,600.00 | \$2,500.00 | \$2,500.00 | \$44,682.00 | \$44,682.00 |
| 2 | MOBILIZATION | PORTABLE RESTROOM | LS | 1 | \$1,000.00 | \$1,000.00 | \$5,904.00 | \$5,904.00 | \$2,500.00 | \$2,500.00 | \$650.00 | \$650.00 |
| 3 | MOBILIZATION | STORAGE CONTAINER | LS | 1 | \$500.00 | \$500.00 | \$1,353.00 | \$1,353.00 | \$1,500.00 | \$1,500.00 | \$550.00 | \$550.00 |
| 4 | MOBILIZATION | TEMPORARY FENCING (APPROXIMATELY 400 LF) | LS | 1 | \$1,200.00 | \$1,200.00 | \$2,952.00 | \$2,952.00 | \$2,500.00 | \$2,500.00 | \$2,100.00 | \$2,100.00 |
| 5 | MOBILIZATION | TEMPORARY WATER AND POWER FOR CONSTRUCTION | LS | 1 | \$1,800.00 | \$1,800.00 | \$9,594.00 | \$9,594.00 | \$2,500.00 | \$2,500.00 | \$2,200.00 | \$2,200.00 |
| 6 | MOBILIZATION | EROSION AND DUST CONTROL | LS | 1 | \$2,200.00 | \$2,200.00 | \$9,594.00 | \$9,594.00 | \$1,500.00 | \$1,500.00 | \$1,500.00 | \$1,500.00 |
| 7 | MOBILIZATION | TREE PROTECTION | EA | 9 | \$50.00 | \$450.00 | \$738.00 | \$6,642.00 | \$200.00 | \$1,800.00 | \$325.00 | \$2,925.00 |
| 8 | MOBILIZATION | INSURANCE AND BONDING | LS | 1 | \$1,500.00 | \$1,500.00 | \$8,610.00 | \$8,610.00 | \$25,000.00 | \$25,000.00 | \$27,000.00 | \$27,000.00 |
| 9 | MOBILIZATION | AS-BUILTS | LS | 1 | \$100.00 | \$100.00 | \$3,075.00 | \$3,075.00 | \$0.00 | \$0.00 | \$500.00 | \$500.00 |
| 10 | MOBILIZATION | SUBMITTALS | LS | 1 | \$50.00 | \$50.00 | \$3,075.00 | \$3,075.00 | \$121,507.10 | \$121,507.10 | \$1,000.00 | \$1,000.00 |
| 11 | MOBILIZATION | CONSTRUCTION STAKING (CIVIL ENGINEER TO CERT BLD PAD) | LS | 1 | \$11,000.00 | \$11,000.00 | \$13,530.00 | \$13,530.00 | \$14,600.00 | \$14,600.00 | \$3,000.00 | \$3,000.00 |
| | | | | Subtotal | | \$77,600.00 | | \$88,929.00 | | \$175,907.10 | | \$86,107.00 |
| 12 | DEMO & GRADING | REMOVAL AND DISPOSAL OF EXISTING GRASS | SF | 3820 | \$1.50 | \$5,730.00 | \$2.20 | \$8,404.00 | \$1.00 | \$3,820.00 | \$3.00 | \$11,460.00 |
| 13 | DEMO & GRADING | REMOVAL AND DISPOSAL OF EXISTING CONCRETE CURB | LF | 12 | \$30.00 | \$360.00 | \$33.00 | \$396.00 | \$25.00 | \$300.00 | \$140.00 | \$1,680.00 |
| 14 | DEMO & GRADING | REMOVAL AND DISPOSAL OF EXISTING 4" CONCRETE | SF | 240 | \$8.00 | \$1,920.00 | \$5.50 | \$1,320.00 | \$5.00 | \$1,200.00 | \$18.00 | \$4,320.00 |
| 15 | DEMO & GRADING | REMOVE AND SALVAGE EXISTING PICNIC TABLES | EA | 2 | \$90.00 | \$180.00 | \$275.00 | \$550.00 | \$250.00 | \$500.00 | \$775.00 | \$1,550.00 |
| 16 | DEMO & GRADING | REMOVAL AND DISPOSAL OF SOIL FOR FLATWORK SUBGRADE | CY | 30 | \$62.00 | \$1,860.00 | \$83.60 | \$2,508.00 | \$40.00 | \$1,200.00 | \$120.00 | \$3,600.00 |
| 17 | DEMO & GRADING | REMOVAL AND DISPOSAL OF SOIL FOR RESTROOM SUBGRADE | CY | 49 | \$62.00 | \$3,038.00 | \$77.00 | \$3,773.00 | \$40.00 | \$1,960.00 | \$110.00 | \$5,390.00 |
| 18 | DEMO & GRADING | REMOVAL AND DISPOSAL SOIL FOR POLIGON FOOTINGS | CY | 9 | \$62.00 | \$558.00 | \$77.00 | \$693.00 | \$40.00 | \$360.00 | \$175.00 | \$1,575.00 |
| 19 | DEMO & GRADING | FINE GRADING AND COMPACTION FOR HARDSCAPE | LS | 1 | \$12,000.00 | \$12,000.00 | \$3,300.00 | \$3,300.00 | \$5,000.00 | \$5,000.00 | \$2,000.00 | \$2,000.00 |
| 20 | DEMO & GRADING | COMPACTION TESTING FOR CONCRETE & BUILDING SUBGRADE | LS | 1 | \$250.00 | \$250.00 | \$2,530.00 | \$2,530.00 | \$2,500.00 | \$2,500.00 | \$3,500.00 | \$3,500.00 |
| | | | | Subtotal | | \$25,896.00 | | \$23,474.00 | | \$16,840.00 | | \$35,075.00 |
| 21 | UTILITIES | PVC SEWER LINE - 4" (STREET TIE IN AND LATERAL LINE) | LF | 82 | \$95.00 | \$7,790.00 | \$184.50 | \$15,129.00 | \$200.00 | \$16,400.00 | \$465.00 | \$38,130.00 |
| 22 | UTILITIES | PROVIDE AND INSTALL 4"-SEWER CLEAN OUT | EA | 1 | \$950.00 | \$950.00 | \$2,583.00 | \$2,583.00 | \$1,500.00 | \$1,500.00 | \$4,000.00 | \$4,000.00 |
| 23 | UTILITIES | NEW 1-1/2"-DOMESTIC WATER LINE SERVICE | LF | 26 | \$75.00 | \$1,950.00 | \$61.50 | \$1,599.00 | \$100.00 | \$2,600.00 | \$1,000.00 | \$26,000.00 |
| 24 | UTILITIES | PROVIDE AND INSTALL 1" DOMESTIC WATER METER & BOX | EA | 1 | \$250.00 | \$250.00 | \$3,200.00 | \$3,200.00 | \$1,500.00 | \$1,500.00 | \$1,500.00 | \$1,500.00 |
| 25 | UTILITIES | PROVIDE AND INSTALL 1" BACKFLOW PREVENTER | EA | 1 | \$1,200.00 | \$1,200.00 | \$2,091.00 | \$2,091.00 | \$2,500.00 | \$2,500.00 | \$4,000.00 | \$4,000.00 |
| 26 | UTILITIES | PROVIDE AND INSTALL SBBC-30SS BACKFLOW ENCLOSURE | EA | 1 | \$1,400.00 | \$1,400.00 | \$1,968.00 | \$1,968.00 | \$2,400.00 | \$2,400.00 | \$4,500.00 | \$4,500.00 |
| 27 | UTILITIES | TRAFFIC CONTROL FOR ITEMS IN STREET (INCLUDING PLAN) | LS | 1 | \$4,500.00 | \$4,500.00 | \$13,500.00 | \$13,500.00 | \$3,000.00 | \$3,000.00 | \$11,000.00 | \$11,000.00 |
| | | | | Subtotal | | \$18,040.00 | | \$40,070.00 | | \$29,900.00 | | \$89,130.00 |
| 28 | HARDSCAPE | 6"-THICK COLORED CONCRETE PAVING WITH REBAR | SF | 2434 | \$19.00 | \$46,246.00 | \$10.70 | \$26,043.80 | \$16.00 | \$38,944.00 | \$9.50 | \$23,123.00 |
| 29 | HARDSCAPE | 6"X6" CONCRETE MOWSTRIP | LF | 23 | \$45.00 | \$1,035.00 | \$64.20 | \$1,476.60 | \$25.00 | \$575.00 | \$125.00 | \$2,875.00 |
| 30 | HARDSCAPE | 3"-LAYER OF STABILIZED DECOMPOSED GRANITE | SF | 80 | \$40.00 | \$3,200.00 | \$32.10 | \$2,568.00 | \$10.00 | \$800.00 | \$36.00 | \$2,880.00 |
| | | | | Subtotal | | \$50,481.00 | | \$30,088.40 | | \$40,319.00 | | \$28,878.00 |
| 31 | SITE FEATURES | BARBEQUE GRILL - CONCRETE | EA | 2 | \$1,055.00 | \$2,110.00 | \$934.80 | \$1,869.60 | \$770.00 | \$1,540.00 | \$1,200.00 | \$2,400.00 |
| 32 | SITE FEATURES | BARBEQUE GRILL INSTALLATION | EA | 2 | \$325.00 | \$650.00 | \$1,082.40 | \$2,164.80 | \$500.00 | \$1,000.00 | \$1,400.00 | \$2,800.00 |
| 33 | SITE FEATURES | PICNIC TABLE - 6' | EA | 2 | \$1,120.00 | \$2,240.00 | \$1,180.80 | \$2,361.60 | \$830.00 | \$1,660.00 | \$1,400.00 | \$2,800.00 |
| 34 | SITE FEATURES | PICNIC TABLE INSTALLATON | EA | 2 | \$350.00 | \$700.00 | \$984.00 | \$1,968.00 | \$500.00 | \$1,000.00 | \$1,400.00 | \$2,800.00 |
| 35 | SITE FEATURES | TRASH RECEPTACLE - CONCRETE | EA | 1 | \$2,035.00 | \$2,035.00 | \$615.00 | \$615.00 | \$1,475.00 | \$1,475.00 | \$2,000.00 | \$2,000.00 |
| 36 | SITE FEATURES | TRASH RECEPTACLE INSTALLATION | EA | 1 | \$250.00 | \$250.00 | \$2,011.05 | \$2,011.05 | \$500.00 | \$500.00 | \$1,000.00 | \$1,000.00 |
| | | | | Subtotal | | \$7,985.00 | | \$10,990.05 | | \$7,175.00 | | \$13,800.00 |
| 37 | SITE STRUCTURES | PROVIDE 24'-WIDE POLYGON PICNIC SHELTER | EA | 1 | \$20,000.00 | \$20,000.00 | \$22,778.09 | \$22,778.09 | \$18,518.80 | \$18,518.80 | \$21,000.00 | \$21,000.00 |
| 38 | SITE STRUCTURES | ASSEMBLE AND INSTALL POLYGON STRUCTURE | LS | 1 | \$8,000.00 | \$8,000.00 | \$11,767.16 | \$11,767.16 | \$17,475.00 | \$17,475.00 | \$22,000.00 | \$22,000.00 |
| 39 | SITE STRUCTURES | FOOTINGS FOR POLYGON STRUCTURE WITH REBAR CAGE | EA | 6 | \$2,200.00 | \$13,200.00 | \$1,045.50 | \$6,273.00 | \$2,500.00 | \$15,000.00 | \$1,100.00 | \$6,600.00 |

Attachment: JFK spreadsheet (2845) : APPROVE AND EXECUTE AGREEMENT FOR THE INSTALLATION

| Item # | Section | Description | Unit | Quantity | KASA Construction, Inc. | | Horizons Construction Inc. | | Epsilon Engineering | | AToM Eng Const, Inc. | |
|--------|-----------------|--|------|--------------|-------------------------|---------------------|----------------------------|---------------------|---------------------|---------------------|----------------------|---------------------|
| | | | | | Unit Price | Line Total | Unit Price | Line Total | Unit Price | Line Total | Unit Price | Line Total |
| | | | | Subtotal | | \$41,200.00 | | \$40,818.25 | | \$50,993.80 | | \$49,600.00 |
| 40 | RESTROOM BLDG | PROVIDE AND INSTALL RESTROOM/STORAGE BUILDING | SP | 1 | \$260,000.00 | \$260,000.00 | \$310,645.11 | \$310,645.11 | \$246,429.00 | \$246,429.00 | \$310,000.00 | \$310,000.00 |
| 41 | RESTROOM BLDG | 24"X18" POUR IN PLACE CONTINOUS FOOTING WITH REBAR | LF | 104 | \$78.00 | \$8,112.00 | \$59.04 | \$6,140.16 | \$100.00 | \$10,400.00 | \$120.00 | \$12,480.00 |
| 42 | RESTROOM BLDG | 2"-THICK LAYER OF COARSE SAND UNDER STRUCTURE | SF | 684 | \$7.00 | \$4,788.00 | \$2.77 | \$1,894.68 | \$2.00 | \$1,368.00 | \$7.00 | \$4,788.00 |
| 43 | RESTROOM BLDG | SAND BACKFILL FOR UTILITIES UNDER RESTROOM STRUCTURE | CY | 14 | \$100.00 | \$1,400.00 | \$79.95 | \$1,119.30 | \$0.00 | \$0.00 | \$350.00 | \$4,900.00 |
| 44 | RESTROOM BLDG | EXPANSION JOINT (BUILDING ADJACENT TO HARDSCAPE) | LF | 81 | \$7.00 | \$567.00 | \$6.89 | \$558.09 | \$10.00 | \$810.00 | \$16.00 | \$1,296.00 |
| 45 | RESTROOM BLDG | DOWEL BUILDING TO ADJACENT HARDSCAPE | LF | 81 | \$18.00 | \$1,458.00 | \$19.68 | \$1,594.08 | \$6.00 | \$486.00 | \$19.00 | \$1,539.00 |
| | | | | Subtotal | | \$276,325.00 | | \$321,951.42 | | \$259,493.00 | | \$335,003.00 |
| 46 | PLANTING | FINE GRADING FOR LANDSCAPE | SF | 742 | \$1.00 | \$742.00 | \$0.69 | \$511.98 | \$5.00 | \$3,710.00 | \$2.50 | \$1,855.00 |
| 47 | PLANTING | SOIL PREP | SF | 742 | \$1.00 | \$742.00 | \$0.81 | \$601.02 | \$5.00 | \$3,710.00 | \$2.00 | \$1,484.00 |
| 48 | PLANTING | WEED ABATEMENT | SF | 742 | \$1.00 | \$742.00 | \$2.00 | \$1,484.00 | \$5.00 | \$3,710.00 | \$1.50 | \$1,113.00 |
| 49 | PLANTING | SHRUBS (1 GAL) | EA | 32 | \$13.00 | \$416.00 | \$12.50 | \$400.00 | \$15.00 | \$480.00 | \$50.00 | \$1,600.00 |
| 50 | PLANTING | SHRUBS (5 GAL) | EA | 37 | \$20.00 | \$740.00 | \$33.75 | \$1,248.75 | \$20.00 | \$740.00 | \$80.00 | \$2,960.00 |
| 51 | PLANTING | SHRUBS (15 GAL) | EA | 7 | \$100.00 | \$700.00 | \$137.50 | \$962.50 | \$25.00 | \$175.00 | \$150.00 | \$1,050.00 |
| 52 | PLANTING | WOOD MULCH | CY | 7 | \$100.00 | \$700.00 | \$125.00 | \$875.00 | \$40.00 | \$280.00 | \$320.00 | \$2,240.00 |
| 53 | PLANTING | SOD REPAIR ALLOWANCE DUE TO CONSTRUCTION | SF | 800 | \$2.50 | \$2,000.00 | \$2.50 | \$2,000.00 | \$3.00 | \$2,400.00 | \$4.00 | \$3,200.00 |
| 54 | PLANTING | 90 DAY MAINTENANCE | LS | 1 | \$5,000.00 | \$5,000.00 | \$8,500.00 | \$8,500.00 | \$1,000.00 | \$1,000.00 | \$8,000.00 | \$8,000.00 |
| | | | | Subtotal | | \$11,782.00 | | \$16,583.25 | | \$16,205.00 | | \$23,502.00 |
| 55 | LIGHTING & ELEC | RESTROOM / PICNIC SHELTER | EA | 1 | \$30,000.00 | \$30,000.00 | \$33,714.30 | \$33,714.30 | \$27,408.00 | \$27,408.00 | \$52,000.00 | \$52,000.00 |
| | | | | Subtotal | | \$30,000.00 | | \$33,714.30 | | \$27,408.00 | | \$52,000.00 |
| 56 | PARKING | NEW STRIPING - DOUBLE LINE STALLS (EXCEPT ADA) | EA | 3 | \$125.00 | \$375.00 | \$676.50 | \$2,029.50 | \$350.00 | \$1,050.00 | \$160.00 | \$480.00 |
| 57 | PARKING | NEW STRIPING (DISABLED) - EMBLEM & SIGN | EA | 1 | \$350.00 | \$350.00 | \$1,045.50 | \$1,045.50 | \$350.00 | \$350.00 | \$220.00 | \$220.00 |
| 58 | PARKING | PROVIDE/INSTALL PRECAST CONCRETE PARKING WHEEL STOP | EA | 1 | \$50.00 | \$50.00 | \$79.95 | \$79.95 | \$350.00 | \$350.00 | \$275.00 | \$275.00 |
| 59 | PARKING | PROVIDE/INSTALL VAN ACCESSIBLE PARKING SIGNAGE | EA | 1 | \$315.00 | \$315.00 | \$184.50 | \$184.50 | \$750.00 | \$750.00 | \$150.00 | \$150.00 |
| 60 | PARKING | POUR IN PLACE CONCRETE RAMP WITH TRUNCATED DOME | EA | 1 | \$3,900.00 | \$3,900.00 | \$3,075.00 | \$3,075.00 | \$2,500.00 | \$2,500.00 | \$3,000.00 | \$3,000.00 |
| | | | | Subtotal | | \$4,990.00 | | \$6,414.45 | | \$5,000.00 | | \$4,125.00 |
| 61 | IRRIGATION | Automatic Irrigation System Modification | LS | 1 | \$20,000.00 | \$20,000.00 | \$9,000.00 | \$9,000.00 | \$9,500.00 | \$9,500.00 | \$1,500.00 | \$1,500.00 |
| 62 | IRRIGATION | Hardline Drip Areas | SF | 742 | \$3.00 | \$2,226.00 | \$3.75 | \$2,782.50 | \$4.87 | \$3,613.54 | \$9.00 | \$6,678.00 |
| | | | | Subtotal | | \$22,226.00 | | \$11,782.50 | | \$13,113.54 | | \$8,178.00 |
| | | | | Total | | \$566,525.00 | | \$624,815.62 | | \$642,354.44 | | \$725,398.00 |

Attachment: JFK spreadsheet (2845 : APPROVE AND EXECUTE AGREEMENT FOR THE INSTALLATION



Report to City Council

TO: Mayor and City Council

FROM: Mel Alonzo, Parks & Community Services Director

AGENDA DATE: December 19, 2017

TITLE: TELECOMMUNICATIONS LICENSE AGREEMENT WITH NEW CINGULAR WIRELESS PCS, LLC, FOR CELL TOWER AT FIRE STATION 91

RECOMMENDED ACTION

Recommendation:

1. Authorize the Mayor to execute an Agreement for a new Telecommunications License Agreement with New Cingular Wireless PCS, LLC, on the property known as Fire Station 91; New Cingular Wireless PCS, LLC site number RS0058.

SUMMARY

Request to enter into an agreement with New Cingular Wireless PCS to install a mono pine and building for transmission of wireless utility at Fire Station 91.

DISCUSSION

Conditional Use Permit (CUP) #PA14-0005 was approved by the Planning Commission in October 2014, for a new wireless telecommunications facility located to the exterior of Fire Station 91 at 16110 Lasselle St.

New Cingular Wireless PCS, a Delaware limited liability corporation, desires to construct a cellular tower (mono pine design) and to license ground space in rear exterior of Fire Station 91 to house equipment to operate the cellular tower.

New Cingular Wireless PCS representatives met with Parks and Community Services and Planning to review and discuss the requirements for obtaining approvals for the project. Parks and Community Services met with M.V. Fire Department to propose the project. New Cingular Wireless PCS designed the installation of a mono pine and

building for transmission of wireless utility at the site. A Telecommunications License Agreement (TLA) was drafted and mailed to New Cingular Wireless PCS' representative and negotiations were concluded as to the license agreement.

The proliferation of various personal communication devices makes additional cellular tower facilities necessary to meet consumer demand. Service providers are installing cellular towers in populated areas throughout the Southern California area in order to accommodate the populace. The proposed Telecommunications License Agreement with New Cingular Wireless PCS, LLC, a Delaware limited liability corporation, is for a term of five (5) years with five (5) additional renewal terms of five (5) years each. For the initial five-year term, the Agreement will provide \$36,000 per year in license fee revenue to the City. In addition, a \$150 per month landscape maintenance and graffiti abatement fee will be paid by the Licensee. Both license fee and the landscape maintenance and graffiti abatement fee include annual increases of three percent (3%). A one-time fee of \$25,000 for granting the license will be paid within thirty (30) days of full execution of the License.

Facility removal, Performance and Labor and Material Bonds have been issued for construction.

ALTERNATIVES

- 1. Authorize the Mayor to execute an Agreement for a new Telecommunications License Agreement with New Cingular Wireless PCS, LLC, on the property known as Fire Station 91; New Cingular Wireless PCS, LLC site number RS0058. *This alternative would result in additional revenue to the City and CSD.*
- 2. Do not authorize the Mayor to execute an Agreement for a new Telecommunications License Agreement with New Cingular Wireless PCS, LLC, on the property known as Fire Station 91; New Cingular Wireless PCS, LLC site number RS0058. *This alternative would result in a loss of potential revenue to the City and CSD.*

FISCAL IMPACT

The proposed agreement will provide revenue to the City in license fee payments of \$38,196 per contract year. The Licensee will pay a \$150 per month landscape maintenance and graffiti abatement fee for use in paying for additional landscape maintenance. Both rent and the landscape maintenance and graffiti abatement fee include annual increases of three percent (3%). The one-time fee of \$25,000 for granting the license will be credited to Parks and Community Services.

Revenue FY 17/18

| | |
|---|---------|
| License Fee – 3 months (Account No. 1010-40-45-30110-463080)..... | \$9,549 |
| Landscape Maintenance and | 450 |

Graffiti Abatement – 3 months (Account No. 1010-40-45-30110-463080).....
 One-time fee (Account No. 5011-50-57-35214-540040)..... 25,000
Total FY 17/18..... \$34,999

Revenue FY 18/19

License Fee – 12 months (Account No. 1010-40-45-30110-463080)..... \$38,196
 Landscape Maintenance and
 Graffiti Abatement – 12 months (Account No. 1010-40-45-30110-463080)..... 1,800
Total FY 18/19..... \$39,996

| DESCRIPTION | FUND | GL ACCOUNT NO. | TYPE (REV/EXP) | FY 17/18 BUDGET | PROPOSED ADJUSTMENTS | FY 17/18 AMENDED BUDGET |
|-----------------|--------|-------------------------|----------------|-----------------|----------------------|-------------------------|
| Fire Operations | GF | 1010-40-45-30110-463080 | REV | \$54,962 | \$9,999 | \$64,961 |
| Parks Projects | Zone A | 5011-50-57-35214-540040 | REV | \$5,000 | \$25,000 | \$30,000 |

| DESCRIPTION | FUND | GL ACCOUNT NO. | TYPE (REV/EXP) | FY 18/19 BUDGET | PROPOSED ADJUSTMENTS | FY 18/19 AMENDED BUDGET |
|-----------------|------|-------------------------|----------------|-----------------|----------------------|-------------------------|
| Fire Operations | GF | 1010-40-45-30110-463080 | REV | \$54,962 | \$39,996 | \$94,958 |

NOTIFICATION

Posting of the agenda.

PREPARATION OF STAFF REPORT

Prepared By:
 Tony Hetherman
 Parks Projects Coordinator

Department Head Approval:
 Mel Alonzo
 Parks and Community Services Director

CITY COUNCIL GOALS

Revenue Diversification and Preservation. Develop a variety of City revenue sources and policies to create a stable revenue base and fiscal policies to support essential City services, regardless of economic climate.

CITY COUNCIL STRATEGIC PRIORITIES

1. Economic Development
2. Public Safety
3. Library
4. Infrastructure
5. Beautification, Community Engagement, and Quality of Life
6. Youth Programs

Objective 1.8: Evaluate staff resources and dedicate City funding to invest in aggressive Economic Development activities that will result in increased revenues to the City, additional employment opportunities, and enhanced quality of life for our residents.

ATTACHMENTS

- 1. TLA WITH NEW CINGULAR WIRELESS PCS AT FIRE STATION 91 PartExe

APPROVALS

| | | |
|-------------------------|-------------------|------------------|
| Budget Officer Approval | <u>✓ Approved</u> | 12/01/17 2:17 PM |
| City Attorney Approval | <u>✓ Approved</u> | 12/04/17 3:20 PM |
| City Manager Approval | <u>✓ Approved</u> | 12/07/17 3:12 PM |

CITY OF MORENO VALLEY
TELECOMMUNICATIONS LICENSE AGREEMENT

This Telecommunications License Agreement ("License") is effective as of the date signed by Licensor and is by and between THE CITY OF MORENO VALLEY, a municipal corporation, hereinafter called "Licensor," and New Cingular Wireless PCS, LLC., a Delaware limited liability company, hereinafter called "Licensee."

The parties agree as follows:

1. Premises.

Licensor owns the real property legally described in Exhibit "A" hereinafter called "Property." Subject to the following terms and conditions, Licensor licenses to Licensee that portion of Licensor's Property depicted in Exhibit "B," including all necessary and reasonable access and utility rights for the installation, operation, and maintenance of Licensee's equipment, structures, and utilities (the "Premises"). Exhibit "C," Conditional Use Permit and Conditions of Approval, is attached hereto and incorporated by reference into this License.

2. Use.

A. The Premises may be used by Licensee for any lawful activity in connection with the provision of mobile/wireless communications services, including without limitation, the transmission and the reception of wireless communication signals on various frequencies and the construction, maintenance and operation of related communications facilities, subject to the terms and conditions of this License.

B. Licensee shall use the Premises in compliance with all applicable laws, statutes, ordinances, rules, regulations and orders in effect.

C. Licensor agrees, at no expense to Licensor, to cooperate with Licensee, in making application for and obtaining all licenses, permits and any and all other necessary approvals that may be required for Licensee's intended use of the Premises.

D. The terms and conditions in this License are offered solely to Licensee as an inducement to execute the License for the Premises. Licensor would not necessarily license the Premises to another licensee on such favorable terms and conditions, it being understood that Licensor is specifically relying on the identity of Licensee in agreeing to the terms and conditions in this License. Licensee acknowledges that the License terms and conditions are for Licensee's benefit only so long as Licensee operates the business allowed by this License. But for the previously stated reasons, Licensor would not enter into this License. Therefore, Licensee shall not voluntarily, involuntarily, or by operation of laws, sublicense all or any part of the Premises or allow it to be assigned or sublicensed to any person or entity other than Licensee except as otherwise permitted under Section 13.

E. Licensee shall not voluntarily, involuntarily, or by operation of laws, sublicense all or any part of the Premises or allow it to be sublicensed, to any person or entity other than Licensee (except as otherwise permitted under Section 13) without the prior written approval of Licensor, which approval will not be unreasonably withheld, delayed or conditioned. In the event Licensee sublicenses or permits the collocation of equipment within the Premises (including the monopine) to another communications carrier, the License Fee (as defined below) due under this License shall increase by an amount equal to Fifty Percent (50%) of the current License Fee at the time of the sublicensing or collocation for each month the additional carrier's equipment is located within the Premises. Notwithstanding anything in this License to the contrary, nothing in this License shall prohibit the shared use of Licensee's Facilities (as defined below) with another party pursuant to a strategic alliance, roaming, or other agreement with Licensee; provided, however, such third party does not install any equipment in or upon the Premises.

3. Conditions Precedent.

This License is conditioned upon Licensee obtaining all necessary federal, state, or local governmental permits and approvals enabling Licensee to construct and operate mobile/wireless communications facilities on the Premises.

4. Term.

A. This License is binding and in effect upon full execution and delivery by Licensor and Licensee. The initial term of this License ("Initial Term") shall be five (5) years commencing on April 1, 2018, the date Licensee commences construction of the Licensee's Facilities (as defined below), whichever comes first. This date shall be referred to as the "Commencement Date". Licensor and Licensee acknowledge and agree that the initial License Fee payment(s) shall not be due by Licensee until thirty (30) days after the Commencement Date. Construction plans must be approved, prior to execution of the License. Licensee shall have the right to extend the Term of this License for five (5) additional terms (each a "Renewal Term") of five (5) years each. The terms and conditions for the Renewal Term shall be the same terms and conditions of this License, except that the License Fee shall be increased as set forth in Section 5. This License shall automatically be extended for each successive five (5) year Renewal Term unless notice is provided in writing of Licensee's intention not to extend this License at least thirty (30) days but not more than 180 days prior to the expiration of the Initial Term or any then existing Renewal Term. The Initial Term and any Renewal Terms are collectively referred to as the Term ("Term").

B. At the expiration of the final Renewal Term of the License Agreement, Licensor and Licensee, at their option, may renegotiate this License.

5. License Fee.

A. In consideration of being granted this License, the Licensee shall pay the Licensor a one-time payment of *Twenty Five Thousand Dollars (\$25,000)*, payable within thirty (30) days of full execution of this License.

B. The payment form (check, money order, etc) shall be referenced as "AT&T RS0058 ONE-TIME". This one-time payment shall be made payable to the City of Moreno Valley, and sent to:

City of Moreno Valley
Parks and Community Services
Attn: Parks Projects Coordinator
14075 Frederick St.
Moreno Valley, CA 92553

C. In consideration of the rights granted by this License, upon the Commencement Date and throughout the Term of this License, Licensee shall pay Licensor the sum of Thirty Eight Thousand, One Hundred Ninety Six Dollars (\$38,196.00) per year as a License Fee ("License Fee"). Commencing on the Commencement Date, the License Fee shall be payable in twelve (12) equal monthly installments, on or before the first day of each month in advance. At the Licensee's option, the Licensee may elect to make yearly payments on or before the first day of the month of the Commencement Date. The License Fee shall increase at a rate of three percent (3%) each year on each anniversary date of the Commencement Date.

D. The payment form (check, money order, etc) shall reference the site "FS91-RS0058". License Fee payments shall be made payable to the City of Moreno Valley, and sent to:

City of Moreno Valley
Attn: Finance Department
P.O. Box 88005
Moreno Valley, CA 92552-0805

E. The License Fee is assessed based on an equipment building not exceeding 300 square feet, and one mono-pine communication tower, as referenced in Exhibit 'B.'

F. If the License Fee is not received by Licensor on or before the fifteenth (15th) day following the due date, it shall be deemed delinquent. If the License Fee is not paid before delinquency, then the amount due and unpaid shall be subject to a monthly late charge at the rate of five percent (5%) of the overdue amount, without limitation to Licensor's other rights and remedies under this License.

G. Licensee may request to expand the Premises. Licensee must submit plans showing the proposed use beyond the existing square footage, and if determined to be in Licensor's best interests, Licensor will provide written consent, which consent will not be unreasonably withheld, conditioned, or delayed. The License Fee shall be increased in proportion to the extra square footage included in the revised premises, based on the current License Fee.

6. Improvements; Access.

A. Licensee shall have the right (but not the obligation) at any time following the full execution and delivery of this License and prior to the Commencement Date, to enter the Premises for the purpose of making necessary inspections and engineering surveys (and soil tests where applicable) and other reasonably necessary tests (collectively "Tests") to determine the suitability of the Premises for Licensee's Facilities (as defined herein) and for the purpose of preparing for the construction of Licensee's Facilities. During any Tests or pre-construction work, Licensee will have in effect the insurance required in Section 12, Insurance. Licensee will notify Licensor of any proposed Tests or pre-construction work and will coordinate the scheduling of same with Licensor. If Licensee determines that the Premises are unsuitable for Licensee's contemplated use, then Licensee will notify Licensor and this License will terminate at Licensee's option.

B. Subject to all terms and conditions of this License, Conditional Use Permit, and Approved Plans and Specs, Licensee has the right to construct, maintain and operate on the Premises wireless communications facilities, including but not limited to, radio frequency transmitting and receiving equipment, batteries, utility lines, transmission lines, radio frequency transmitting and receiving antennas and structures, ("Licensee's Facilities") and lighting as specifically identified on the attached Exhibit B. In connection therewith, Licensee has the right to do all work necessary to prepare, add, maintain and alter the Premises for Licensee's communications operations and to install utility lines and transmission lines connecting antennas to transmitters and receivers, except that any change to the Licensee's Facilities adversely and materially affecting the visual appearance of the Premises, any modification of equipment which places an additional load on the Licensor's electrical system requiring an increase in Licensee's 200 amp service panel size and capacity shall be prohibited until approved in writing by Licensor, and such approval will not be unreasonably withheld, unreasonably conditioned or unreasonably delayed. Notwithstanding the forgoing, Licensee shall be entitled to exchange and replace equipment and antennas within the Premises provided that (i) any new equipment is either not physically or materially greater in size or not visible to the public; or (ii) any antennas are not greater in size than those previously installed.

C. Licensee shall submit an application to the City of Moreno Valley for a Conditional Use Permit and pay all applicable fees. Subject to the approval of a Conditional Use Permit, Licensee shall construct, maintain and operate said Facilities in accordance with the Conditions of Approval as set forth by the City's Planning Division, Building and Safety Division, Parks and Community Services Department, and the Fire Prevention Bureau, et al, during the plan review process.

D. Licensee shall obtain and pay for all building permits and fees as required. Licensor approved temporary fencing shall be placed and maintained around the construction site for the duration of construction.

E. As part of the installation of Licensee's Facilities, Licensee shall have the right to install electrical service, at Licensee's expense, including, but not limited to primary power and installation of an emergency back-up power system for Licensee's Facilities. Subject to Licensor's approval of the location, which approval shall not be unreasonably withheld, conditioned or delayed. Licensee shall have the right to place utilities on (or to bring utilities across) Licensor's Property in order to service the Premises and Licensee's Facilities.

F. Licensee shall use its best efforts to commence and diligently pursue all of the construction and installation work described in this Section 6 so as to fully complete said work within 180 days of the Commencement Date subject to reasonable extension of time due to events of force majeure, delays in obtaining government approvals necessary to properly install and operate Licensee's Facilities, or as otherwise required by Licensee.

G. All of Licensee's construction and installation work shall be performed at Licensee's sole cost and expense, in a good and workmanlike manner as defined by the prevailing industry standard for public works projects.

H. Licensee shall provide and maintain in effect three (3) good and sufficient Surety Bonds as follows:

The first bond shall be a "Faithful Performance Bond," which shall be in an amount of *one hundred thousand dollars (\$100,000)* and shall guarantee the faithful performance of all work related to the removal of the Licensee's Facilities as required herein. This Faithful Performance Bond for facility removal shall be required to be kept in place during the entire term of the License.

The second bond shall be a "Faithful Performance Bond," which shall be in an amount of *three hundred thousand dollars (\$300,000)* and shall guarantee the faithful performance of all the work related to the construction of the Licensee's Facilities as required herein.

The third bond shall be a "Labor and Materials Payment Bond," which shall be in an amount of *three hundred thousand dollars (\$300,000)* and shall secure the payment of the claims of labor, mechanics, or materialmen pursuant to Section 3115 and 3143 of the Civil Code for all work related to the installation of Licensee's Facilities.

The 'construction-related' "Faithful Performance Bond" and the "Labor and Materials Bond" shall be kept in place until such time as Licensor approves in writing the final installation of the Licensee's Facilities, which approval shall not be unreasonably withheld, conditioned or delayed. Upon such approval from Licensor, the 'construction related' Faithful Performance Bond and the Labor and Materials Payment Bond may be terminated. All bonds shall be Licensor approved, prior to the issuance of building permits, which approval shall not be unreasonably withheld, conditioned or delayed.

I. Title to Licensee's Facilities installed or placed on the Premises by Licensee shall be held by Licensee. Licensee has the right to remove all of Licensee's Facilities at its sole expense on or before the expiration or termination of this License, except those portions of Licensee's Facilities which are fully integrated into Licensor owned property, provided however, no Licensee owned equipment shall be considered fully integrated into Licensor owned property under any circumstance. Upon termination of this License the Licensor shall have the option to have Licensee's structures and buildings removed at Licensee's sole expense or to have them remain in place. The Licensor will notify the Licensee thirty (30) days prior to the termination or expiration of this License as to the option of leaving or removing the building. If said building is allowed to remain in place, title to same shall revert to the Licensor. Licensor shall take title to said facilities in their then existing "AS-IS, WHERE-IS" condition, without representation or warranty from Licensee. All of Licensee's communication equipment shall at all times be and remain Licensee's personal property, not be considered fixtures, and in no event shall any part of Licensee's communications equipment be deemed or considered "integrated into Licensor owned property", and Licensor agrees that Licensee's communications equipment shall be exempt from execution, foreclosure, sale, levy, attachment or distress for any License Fee due or to become due. Notwithstanding anything to the contrary contained herein, in the event Licensee ceases to pay License Fee for a period of more than six (6) consecutive months and abandons its communications equipment at the Premises, Licensor shall be entitled to remove Licensee's communications equipment from the Premises and dispose of it in any commercially reasonable manner it deems fit.

J. Licensor shall provide continuous access to Licensee, Licensee's employees, agents, contractors and subcontractors a designated access route on Exhibit B to the Premises twenty-four (24) hours a day, seven (7) days a week, at no charge to Licensee. In the event said route is obstructed, Licensor shall provide Licensee another suitable route of access to Licensee's Premises. Licensor represents and warrants that it has full rights of ingress to and egress from the Premises, and hereby grants such rights to Licensee to the extent required to construct, maintain, install and operate Licensee's Facilities on the Premises. Licensee's exercise of such rights shall not cause undue inconvenience to the Licensor. Except in the event of an emergency (including equipment failure), Licensee shall provide a minimum of twenty-four (24) hours notice to the Licensor prior to access of the Premises for scheduled routine maintenance and other major work.

K. For additional access and utility rights beyond those provided to Licensee by Licensor in this License, it shall be the responsibility of Licensee to obtain and pay for all additional easements, rights of entry and all incidentals necessary to Licensee's operations upon the Premises.

L. Licensor shall maintain an access pathway from a public roadway to the Premises in a manner sufficient to allow access for Licensee's use of the Premises. Licensor shall be responsible for maintaining and repairing such access pathway, at its sole expense, except for any damage caused by Licensee's use of such access pathway; or replace damaged items. If Licensee causes any such damage, Licensee shall promptly repair all damages within 10 (ten) working days of Licensee's receipt of

written notice from the Licensor. If the Licensee fails to make such repair or replacement within 10 (ten) working days of Licensee's receipt of written notice, the Licensor may cause the work to be done and the costs incurred thereby shall become the liability of the Licensee, and the Licensor shall be reimbursed said cost.

M. Licensee shall fully and promptly pay for all utilities used by Licensee for the use, operation and maintenance of Licensee's Facilities in the Premises.

N. Licensor shall be entitled to enter the Premises, in the presence of a Licensee representative, at any time to inspect Licensee's facilities for compliance with the terms of this License, and with all applicable Federal, State and local governmental regulations.

7. Repairs, Maintenance, Landscaping, and Graffiti.

A. Licensee shall be responsible for repairing and maintaining Licensee's Facilities and any other improvements installed by Licensee on the Premises in a reasonably acceptable aesthetic appearance, proper operating, and reasonably safe condition. This shall include the repair of all damage to Licensee's Facilities incurred whether natural or man made.

B. Upon the Commencement Date of the License, Licensor shall be responsible for all graffiti removal and abatement at the Premises (with the exception of personal and real property while under construction). Licensee shall pay a graffiti removal and landscape maintenance fee in the amount of **One Hundred, Fifty Dollars (\$150) per month** for said service. The abatement and landscape maintenance fee shall be noted as a separate line item but included in the License Fee payment. The graffiti removal and landscape maintenance fee shall increase at a rate of three percent (3%) each year, on the anniversary date of the Commencement Date of the License, for the remaining Term of the License. Licensor shall be responsible for Licensee installed landscaping and irrigation, and concrete pathway maintenance located outside of the Premises. The landscape, irrigation and concrete pathway maintenance is reflected in the said fee.

8. Interference with Communications.

A. Licensee agrees to install equipment of types and frequencies which will not cause harmful interference to the currently existing communications equipment (as configured) of Licensor's vendors, or other pre-existing licensees or lessees of the Premises which exist as of the execution date of this License. In the event Licensee's equipment causes such interference, Licensee shall cooperate with Licensor in determining the source and will immediately take all steps necessary to correct and eliminate the interference. If said interference cannot be eliminated within forty-eight (48) business hours after receipt of written notice from Licensor to Licensee of the existence of such interference and Licensee and Licensor have reasonably determined Licensee's equipment to be the source of said interference, Licensee shall discontinue use of the equipment creating said interference until such interference is corrected. Licensor shall not be liable to Licensee for any interruption of service of

Licensee unless caused by Licensor or for interference with the operation of Licensee's equipment unless caused by Licensor.

B. Notwithstanding the foregoing, in the event that said interference interferes with Licensor's own equipment as configured and installed prior to the date of Licensee's equipment and in Licensor's sole and reasonable judgment, said interference jeopardizes the safe operation of Licensor's operations, Licensee will be responsible for eliminating the interference within twenty-four (24) hours, upon becoming aware of such interference. Licensee shall shut down the interfering equipment except for intermittent operations for the purpose of testing if Licensee is unable to eliminate said interference within twenty-four (24) hours of said notification. If Licensor disconnects power to the facility, Licensor will allow intermittent power to Licensee for equipment testing only.

C. Licensee has satisfied itself and hereby represents and warrants to Licensor that, to the best of Licensee's knowledge, no such interference shall result to the currently existing systems (as configured) of Licensor or other pre-existing licensees or lessees at the Property. Licensee agrees to indemnify, hold harmless and defend Licensor against any claim or damage, including reasonable attorney's fees, arising out of such interference.

D. Licensee shall be responsible for performing and providing documentation to the Licensor for all engineering studies to ensure that the placement of its equipment at the Premises will not cause interference with any existing equipment (as configured at the time of execution of this License) placed there by Licensor and/or any other pre-existing licensees or lessees.

E. It is emphasized that the primary use of the Premises is intended to include future and presently unknown Licensor uses, the integrity and security of which shall in no way be compromised by the Licensee. If during the Term of the License, Licensor's present or future operations requires installation of additional telecommunications equipment adjacent to the Premises, Licensor agrees to take all reasonable steps necessary not to affect or interfere with Licensee's right hereunder. If, however, such interference occurs despite the best efforts of both Licensor and Licensee, the Licensor's operational need shall prevail and Licensee shall be required to modify or remove their interfering equipment.

F. Excepting pre-existing equipment located on the Property prior to the date of this License, Licensor shall not allow any use of the Property which interferes with Licensee's use of the Premises. If such interference occurs, Licensor shall promptly correct such interference within forty-eight (48) hours of Licensor's receipt of written notice from Licensee.

9. Taxes.

Licensee shall pay all taxes assessed against Licensee's Facilities. Pursuant to California Revenue and Taxation Code section 107.6, Licensee is notified that the property interest acquired by Licensee in the Premises under this License may be

subject to property taxation as a possessory interest in real property, and Licensee may be subject to the payments of property taxes levied on that interest.

10. Termination.

This License shall not be revoked or terminated during the Term, except as expressly stated in this License. This License may be terminated on thirty (30) days prior written notice (except where stated otherwise) as follows:

A. by either party upon a default of any covenant, condition, or term hereof by the other party, which default is not cured within sixty (60) days of receipt of written notice of default, provided that if such default is curable, but not curable within such sixty (60) day period, then within such period of time as is reasonably necessary to accomplish such cure (in order to avail itself of this time period in excess of sixty (60) days, the defaulting party must send to the other party, within the sixty (60) day period, a written plan to cure the default, which is reasonably acceptable to the other party, and the defaulting party diligently commences and continues performance of such cure to completion according to the written plan);

B. by Licensee if it does not obtain or maintain licenses, permits or other approvals necessary to the construction or operation of Licensee's Facilities; however, Licensee shall act with due diligence to obtain and maintain such agreements, licenses, permits, and other approvals;

C. by Licensee if Licensee is unable to occupy or utilize the Premises due to ruling or directive of the Federal Communications Commission ("FCC") or other governmental or regulatory agency, including, but not limited to, a take back of channels or change in frequencies;

D. by Licensee if Licensee determines that the Premises are not appropriate for its operations for economic, environmental or technological reasons, including without limitation, signal strength or interference; or

E. by Licensee for any reason or for no reason provided Licensee delivers written notice of termination to Licensor prior to the Commencement Date.

F. In the event of a termination of this License by Licensee, if Licensee determines that the Premises are not appropriate for its operations for economic, environmental or technological reasons, including without limitation, signal strength or interference which occurs at any time within the Initial Term of this License, Licensee shall be required to provide Licensor a minimum of three (3) months prior written notice of termination of the License.

G. In the event of a termination of this License for any cause in any Renewal Term, except default and failure to cure by Licensor, Licensee shall not receive a refund of any License Fee paid in advance to Licensor.

11. Condemnation.

If a condemning authority takes all of Licensor's Property, or a portion which in Licensee's opinion is sufficient to render the Premises unsuitable for Licensee's use, then this License shall terminate as of the date when possession is delivered to the condemning authority. In any condemnation proceeding each party shall be entitled to make a claim against the condemning authority for just compensation (which for Licensee shall include the value of Licensee's Facilities, prepaid License Fee, and any other amounts recoverable under condemnation law). Sale of all or part of the Premises to a purchaser with the power of eminent domain in the face of the exercise of its power of eminent domain shall be treated as a taking by a condemning authority.

12. Insurance

A. Licensee shall maintain in full force and effect, at no expense to Licensor, the following insurance:

1. Commercial general liability insurance in the amount of one million dollars (\$1,000,000) per occurrence, four million dollars (\$4,000,000) aggregate for death, bodily injury, personal injury, or property damage;
2. Auto Liability insurance endorsed for "any auto" with limits of liability of one million dollars (\$1,000,000) per accident for bodily injury and property damage;
3. Employer's Liability insurance with limits of liability of one million dollars (\$1,000,000), each accident; one million dollars (\$1,000,000) disease each employee; and one million dollars (\$1,000,000) disease policy limit.

B. The insurance coverage required of the Licensee by section 12 shall also meet the following requirements:

1. The insurance shall be primary with respect to any insurance or coverage maintained by Licensor, as relates to Licensee's operations, and shall not call upon Licensor insurance or coverage for any contribution but only to the extent caused by Licensee, its agents or contractors.
2. The insurance policies shall include contractual liability and personal injury. Notwithstanding the forgoing, Licensee may, in its sole discretion, self insure any of the required insurance under the same terms as required by this Agreement. In the event Licensee elects to self-insure its obligation under this Agreement to include Licensor as an additional insured, the following conditions apply:
 - (i) Licensor shall promptly and no later than thirty (30) days after notice

thereof provide Licensee with written notice of any claim, demand, lawsuit, or the like for which it seeks coverage pursuant to this Section and provide Licensee with copies of any demands, notices, summonses, or legal papers received in connection with such claim, demand, lawsuit, or the like; (ii) Licensor shall not settle any such claim, demand, lawsuit, or the like without the prior written consent of Licensee; and (iii) Licensor shall fully cooperate with Licensee in the defense of the claim, demand, lawsuit, or the like.

3. The insurance policies shall include the City of Moreno Valley, the Moreno Valley Housing Authority, and the Moreno Valley Community Services District (CSD), its officers, agents, employees, and volunteers, as additional insureds under the policies; and shall include substantially the following provisions:

“Moreno Valley Community Services District (CSD), the City of Moreno Valley (City), the Moreno Valley Housing Authority, and their officers, officials, employees, agents, and volunteers are additional insureds as respects to General Liability and Auto Liability insurance. This insurance is primary, and our obligations are not affected by any other insurance carried by such additional insured whether primary, excess, contingent, or on any other basis. Waiver of subrogation for Workers’ Compensation and Employer’s Liability insurance as respects to the Moreno Valley Community Services District (CSD), the City of Moreno Valley (City), the Moreno Valley Housing Authority and each of their officers, officials, employees, agents, and volunteers.”

- A. For the Commercial General Liability coverage, said parties shall be named as additional insureds utilizing either:
 1. Insurance Services Office (“ISO”) Additional Insured endorsement CG 20 10 (04/13); or
 2. Substitute endorsements providing equivalent coverage, approved by the City.
 3. Licensor’s additional insured status shall (i) be limited to bodily injury, property damage or personal and advertising injury caused, in whole or in part, by Licensee, its employees, agents, or independent contractors; (ii) not extend to claims for punitive or exemplary damages arising out of the acts or omissions of Licensor, its employees, agents or independent contractors or where such coverage is prohibited by law or to claims arising out of the gross negligence of Licensor, its employees, agents or independent contractors; and, (iii) not exceed Licensee’s indemnification obligation under this Agreement, if any.
- B. The endorsements shall be signed by a person authorized by the insurer to bind coverage on its behalf. The coverage shall contain no special limitations on the scope of protection afforded to such additional insureds. Coverage for such additional insureds does not extend to liability to the extent prohibited by Insurance Code Section 11580.4.
- C. All policies of insurance required by the Contract Documents shall include or be endorsed to provide a waiver by the insurers of any rights of recovery or subrogation that the insurers may have at any time against the “Moreno

Valley Community Services District (CSD), the City of Moreno Valley (City), the Moreno Valley Housing Authority, and their officers, officials, employees, agents, and volunteers.”

- D. All policies and endorsements shall stipulate that the Licensee’s (and its Subcontractors’) insurance coverage shall be primary and noncontributory insurance as respects the *“Moreno Valley Community Services District (CSD), the City of Moreno Valley (City), the Moreno Valley Housing Authority, and their officers, officials, employees, agents, and volunteers,”* and shall be excess of the Licensee’s (and its Subcontractors’) insurance and shall not contribute with it.

For the primary and noncontributory coverage, said parties shall be named as additional insureds utilizing either:

1. Insurance Services Office (“ISO”) Additional Insured endorsement CG 20 10 (01/13); or
2. Substitute endorsements providing equivalent coverage, approved by the City.
3. Coverage shall state that the Licensee’s (and its Subcontractors’) insurance shall apply separately to each insured or additional insured against whom claim is made or suit is brought, except with respect to the limits of the insurer’s liability. Coverage shall apply to any claim or suit brought by an additional insured against a named insured or other insured.
4. Licensee shall provide to Licensor’s Attorney, (a) Certificates of Insurance evidencing the insurance coverage required herein, and (b) specific endorsements or blanket additional insured endorsements including Licensor, its officers, employees, agents, and volunteers, as additional insureds under the required liability policies;
5. Licensee shall provide at least thirty (30) days written notice to Licensor’s Attorney ten (10) days notice shall apply to non-payment) of any cancellation or non renewal of any required coverage that is not replaced.
6. If the insurance is written on a Claims Made Form, then, following termination of this License, said insurance coverage shall survive for a period of not less than five (5) years;
7. The insurance policies shall provide for a retroactive date of the placement of Licensee’s Facilities coinciding with the effective date of this License;
8. The insurance shall be reasonably approved as to form and sufficiency by the Licensor’s Attorney.

- E. If it employs any person, Licensee shall maintain worker’s compensation and employer’s liability insurance, as required by the State Labor Code and other applicable laws and regulations.

13. Successors and assigns.

Licensee may assign this License at any time upon written notice to and approval of Licensor, which approval shall not be unreasonably withheld, conditioned or delayed,

provided, however, Licensee shall have the right to sublicense or assign its rights under this License without consent of Licensor, (i) to any of its partners, members, subsidiaries, affiliates or successor legal entities, (ii) to any entity acquiring substantially all of the assets of Licensee in the geographic region the Premises are located, or (iii) to any entity in connection with any financing, loan, security interest, pledge, or mortgage of Licensee's property. This License shall inure to the benefit of and be binding upon the heirs, successors and assigns of the parties.

14. Environmental Indemnification; Hazardous substances.

A. Licensee hereby represents, warrants, covenants and agrees to and with Licensor that all of Licensee's operations or activities upon, or any use or occupancy of the Property by Licensee, or any portion thereof, by Licensee, shall be in all respects in compliance with all applicable state, federal and local laws and regulations governing or in any way relating to the generation, handling, manufacturing, treatment, storage, use, transportation, spillage, leakage, dumping, discharge, or disposal (whether legal or illegal, accidental or intentional) of any Hazardous Substance (as defined below).

B. If any investigation or monitoring of site conditions or any clean-up, containment, restoration, removal or other remedial work (collectively, the "Remedial Work") is required under any applicable federal, state or local law or regulation, by any judicial order, or by any governmental entity due to any Hazardous Substances brought on to or generated on the Property by Licensee, Licensee shall perform or cause to be performed the Remedial Work in compliance with such law, regulation, or order. All costs and expenses of such Remedial Work shall be paid by Licensee including, without limitation, all charges of Licensee's contractors, consultants and engineers and Licensor's reasonable attorney, architect's and/or consultant's fees and costs incurred in connection with monitoring or review of such Remedial Work. In the event Licensee shall fail to timely commence, or cause to be commenced, or fail to diligently prosecute to completion, such Remedial Work, Licensor may, but shall not be required to, cause such Remedial Work to be performed, and all reasonable costs and expenses thereof, or incurred in connection therewith, shall be reimbursed to Licensor.

C. "Hazardous Substances" shall include without limitation:

1. Those substances included within the definitions of "hazardous substances," "hazardous materials," "toxic substances," or "solid waste" in the Comprehensive Environmental Response Compensation and Liability Act of 1980 (42 U.S.C. § 9601 et seq.) ("CERCLA"), as amended by Superfund Amendments and Reauthorization Act of 1986 (Pub. L. 99-499 100 Stat. 1613) ("SARA"), the Resource Conservation and Recovery Act of 1976 (42 U.S.C. § 6901 et seq.) ("RCRA"), and the Hazardous Materials Transportation Act, 49 U.S.C. § 1801 et seq., and in the regulations promulgated pursuant to said laws, all as may be amended from time to time;

2. Those substances listed in the United States Department of Transportation Table (49 CFR 172.101 and amendments thereto) or by the Environmental Protection Agency (or any successor agency) as hazardous substances (40 CFR Part 30, and as may be amended from time to time);

3. Any material, waste or substance which is petroleum, asbestos, polychlorinated biphenyls, designated as a "hazardous substance" pursuant to Section 311 of the Clean Water Act, 33 U.S.C. 1251 et seq. (33 U.S.C. § 1321) or listed pursuant to Section 307 of the Clean Water Act (33 U.S.C. § 1317); or radioactive materials; and such other substances, materials, and wastes which are or become regulated as hazardous or toxic under applicable local, state, or federal law, or the United States government, or which are classified as hazardous or toxic under federal, state, or local laws or regulations.

15. Indemnity and Mutual Release.

Licensor and Licensee each indemnifies the other against and holds the other harmless from any and all costs (including reasonable attorney's fees) and claims of liability or loss to the extent arising from the ownership, use and/or occupancy of the Licensor's Property or Premises by the indemnifying party. This indemnity does not apply to any claims arising from the negligence or intentional misconduct of the indemnified party, breach of this License by the indemnified party, or violation of law by the indemnified party. The indemnity obligations under this Section will survive the termination of this License.

16. Attorneys' fees; Litigation costs.

A. If any action at law or in equity is brought to recover any License Fee or other sums under this License, or for or on account of any breach of or to enforce or interpret any of the covenants, terms, or conditions of this License, or for the recovery of the possession of the Premises, the prevailing party shall be entitled to reasonable attorneys' fees, costs and other expenses, in addition to any other relief to which such party may be entitled to the extent award by a court of law.

B. Whenever provision is made in this License for the payment of attorney's fees, such fees shall be payable whether the legal services are rendered by a salaried employee for the party or by independent counsel and shall include such fees as are incurred in connection with any pretrial proceeding, trial or appeal of the action.

C. Any award of damages following judicial remedy or arbitration as a result of the breach of this License or any of its provisions shall include an award of prejudgment interest from the date of the breach at the lesser of (i) the maximum amount of interest allowed by law or (ii) Ten Percent (10%).

17. Waiver of Incidental and Consequential Damages.

With the exception of the indemnification obligations identified within this License, neither party will assert any claim whatsoever against the other party for loss of anticipatory profits or any other indirect, special, incidental or consequential damages

incurred as a result of the construction, installation, operation, maintenance, or replacement of personal property owned by either party, or Licensor's or Licensee's use of the Premises or Licensor's Property, including any and all losses incurred as a result of Licensor's or Licensee's actions or defaults.

18. Miscellaneous.

A. Severability. If any provision of the License is invalid or unenforceable with respect to any party, the remainder of this License or the application of such provision to persons other than those as to whom it is held invalid or unenforceable, shall not be affected and each provision of this License shall be valid and enforceable to the fullest extent permitted by law.

B. Notices. Any notice or demand required to be given herein shall be made by certified or registered mail, return receipt requested, or trackable overnight mail to the address of the respective parties set forth below. Any change in address shall be promptly reported to affected party.

Licensor:

Parks and Community Services
Attn: Director
City of Moreno Valley
14075 Frederick Street
Moreno Valley, CA 92553

Licensee:

New Cingular Wireless PCS, LLC.
Attn: Network Real Estate Administration
Re: Cell Site# RS0058
Cell Site Name: Mo Val Fire
Fixed Asset#: 10103911
575 Morosgo Drive NE, 13F
West Tower, Atlanta, CA 30324

A copy to be sent to:

Licensor:

City Manager
City of Moreno Valley
P.O. Box 88005
14177 Frederick Street
Moreno Valley, CA 92552-0805

Licensee:

New Cingular Wireless PCS, LLC.
Attn: AT&T Legal Dept. – Network Operations
Re: Cell Site# RS0058
Cell Site Name: Mo Val Fire
Fixed Asset#: 10103911
208 S Akard Street
Dallas, TX 75202-4206

C. Choice of Law. This License shall be governed under the laws of the State of California and applicable Federal law.

D. Survival of Terms. Terms and conditions of this License which by their sense and context survive the termination, cancellation or expiration of this License will so survive.

E. Entire Agreement. The terms of this License (including the Exhibits, all of which are hereby incorporated by reference) are intended by the parties as the final expression of their agreement with respect to such terms. The parties further intend that this License constitutes the complete and exclusive statement of its terms and no extrinsic evidence whatsoever may be introduced in any proceeding, involving this

License. The language in all parts of this License will in all cases be construed as a whole and in accordance with its fair meaning and not construed for or against either party.

F. Amendments and Modifications. No amendments, modification or supplement, including those by custom, usage of trade, or course of dealing, of any provisions of this License shall be binding on any of the parties unless it is in writing and signed by the parties in interest at the time of the modification. No oral order, objection, claim, or notice by either party to the other shall affect or modify any of the terms or obligations contained in the License.

G. Venue. At Licensor's option, any action by any party to this License shall be brought in the appropriate court of competent jurisdiction within the County of Riverside, notwithstanding any other provision of law which may provide that such action may be brought in some other location.

H. Waiver. Failure by a party to insist upon the strict performance of any of the provisions of this License by the other party, or the failure by a party to exercise its rights upon the default of the other party shall not constitute a waiver of such party's right to insist and demand strict compliance by the other party with the terms of this License thereafter.

[Signatures Appear on the Following Page]

IN WITNESS WHEREOF, Licensor and Licensee have executed this Telecommunications License Agreement as of the date and year signed by Licensor.

Licensor:
City of Moreno Valley

Licensee:
New Cingular Wireless PCS, LLC.
a Delaware limited liability company
By: AT&T Mobility Corporation
Its: Manager

BY: _____
MAYOR

Federal I.D. No.: 84-1659970

DATE: _____

PRINT NAME: JAMES STICKNEY

| | |
|----------------------------|---------------|
| <u>INTERNAL USE ONLY</u> | |
| ATTEST: | _____ |
| | City Clerk |
| APPROVED AS TO LEGAL FORM: | _____ |
| | City Attorney |
| | _____ |
| | Date |

SIGNATURE: _____

TITLE: DIRECTOR C & E

DATE: 10-16-17

PRINT NAME: _____

SIGNATURE: _____

TITLE: _____

DATE: _____

SIGNING INSTRUCTIONS TO LICENSEE:

Signature(s) must be accompanied by a completed notary certificate of acknowledgement attached hereto. A general partner must sign on behalf of a partnership. **Two (2)** corporate officers must sign on behalf of a corporation unless the corporation has a corporate resolution that allows one person to sign on behalf of the corporation; if applicable, said resolution must be attached hereto. The corporate seal may be affixed hereto.

Enclosures:

- Exhibit "A" – Legal Description of the Property
- Exhibit "B" – Description of Premises, Licensee's Facilities, Incorporation of Approved Construction Plans by Reference
- Exhibit "C" – Conditional Use Permit and Conditions of Approval

Attachment: TLA WITH NEW CINGULAR WIRELESS PCS AT FIRE STATION 91 PartExe (2846 : TELECOMMUNICATIONS LICENSE AGREEMENT



NEW CINGULAR WIRELESS PCS, LLC

ASSISTANT SECRETARY'S CERTIFICATE

I, Joanne F. Todaro, do hereby certify that I am a duly elected and qualified Assistant Secretary of AT&T Mobility Corporation, the Manager of New Cingular Wireless PCS, LLC, a Delaware limited liability company (the "Company"), and as such I am authorized to execute this certificate. In such capacity, I further certify that:

1. The Schedule of Authorizations for Affiliates of AT&T Inc. (the "Schedule") has been duly adopted by the Company, and said Schedule remains in full force and effect on the date hereof.
2. Section 5.1 of the Company's Limited Liability Company Operating Agreement as amended on August 29, 2007 designates AT&T Mobility Corporation as the Manager of the Company, and AT&T Mobility Corporation remains the Manager of the Company on the date hereof.
3. AT&T Mobility Corporation as the Manager of the Company has the authority under Section 5.6 of the Company's Limited Liability Company Operating Agreement to manage all of the business affairs of the Company.
4. Section 5.15 of the Company's Limited Liability Company Operating Agreement states as follows:

"Any person or entity dealing with the Company may rely on a certificate signed by the Manager or officer on any document purporting to bind the Company shall constitute exclusive evidence to third parties of the authority of such person to execute such document on behalf of the Company and so bind the Company."
5. James Stickney, Director Construction & Engineering, is authorized and empowered under the Schedule and by the Manager of the Company to execute in the name of and on behalf of the Company that certain City of Moreno Valley Telecommunications License Agreement regarding the Mo Val Fire site, by and between the City of Moreno Valley, California, and the Company.

IN WITNESS WHEREOF, the undersigned has affixed her signature this 17th day of October, 2017.

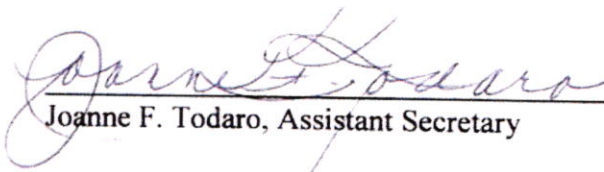

 Joanne F. Todaro, Assistant Secretary

ACKNOWLEDGMENT

A notary public or other officer completing this certificate verifies only the identity of the individual who signed the document to which this certificate is attached, and not the truthfulness, accuracy, or validity of that document.

State of California
County of Orange

On October 16, 2017 before me, Cecilia Sifuentes - Notary Public
(insert name and title of the officer)

personally appeared James Stickney
who proved to me on the basis of satisfactory evidence to be the person(s) whose name(s) is/are subscribed to the within instrument and acknowledged to me that he/~~she/they~~ executed the same in his/~~her/their~~ authorized capacity(ies), and that by his/~~her/their~~ signature(s) on the instrument the person(s), or the entity upon behalf of which the person(s) acted, executed the instrument.

I certify under PENALTY OF PERJURY under the laws of the State of California that the foregoing paragraph is true and correct.

WITNESS my hand and official seal.

Signature *Cecilia Sifuentes* (Seal)

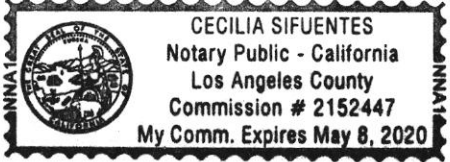

Attachment: TLA WITH NEW CINGULAR WIRELESS PCS AT FIRE STATION 91 PartExe (2846 : TELECOMMUNICATIONS LICENSE AGREEMENT

The Commission hereby certifies that the information provided by the applicant is true and correct to the best of the applicant's knowledge and belief, and that the applicant is qualified to provide the services described in the application.

State of Michigan
 Department of Telecommunications
 225 North Zeeb Road
 Lansing, Michigan 48906
 Telephone: (517) 373-3000
 Fax: (517) 373-3001
 Website: www.michigan.gov/telecom

EXHIBIT A

LEGAL DESCRIPTION OF CITY'S PROPERTY

Licensors's Property of which Premises are a part is legally described as follows:

All that certain real property situated in the County of Riverside, State of California, described as follows:

That portion of Amended Parcel Map No. 16,950, as shown by Parcel Map on file in Book 113 Pages 62 through 70 inclusive of Parcel Maps, records of Riverside County, California, described as follows:

Beginning at the intersection of the Northerly line of that parcel of land conveyed to Riverside City College Foundation as described in Deed recorded March 16, 1987, as Instrument No. 71344, of Official Records of Riverside County, California, with the Easterly right-of-way line of Lasselle Street as shown by Parcel Map No. 20557 on file in Book 147 at Pages 20 through 27, of Official Records of Riverside County, California, said intersection being the beginning of a curve concave Westerly having a radius of 1661.50 feet, a radial line to said beginning point bears North $82^{\circ} 55' 18''$ East;

Thence Northerly along said Easterly line of Lasselle Street and along said curve through a central angle of $13^{\circ} 24' 17''$ an arc length of 388.72 feet to a point at the beginning of a line nontangent to last said curve;

Thence North $54^{\circ} 01' 07''$ East a distance of 478.60 feet;

Thence South $35^{\circ} 58' 53''$ East a distance of 162.82 feet;

Thence North $54^{\circ} 01' 07''$ East a distance of 202.28 feet to the Westerly line of that parcel of land conveyed to Riverside City College Foundation as described in deed recorded March 16, 1987 as Instrument No. 71343, of Official Records of Riverside County, California;

Thence along said Westerly line to and along the Westerly line of land conveyed in said deed recorded March 16, 1987 as Instrument No. 71344 of Official Records of Riverside County, California, South $05^{\circ} 29' 10''$ West 261.47 feet;

Thence along the Northerly line of land described in said deed recorded March 16, 1987 as Instrument No. 71344 of Official Records of Riverside County, California, South $53^{\circ} 59' 22''$ West 654.27 feet to the point of beginning.

Assessor's Parcel Number: 308-030-018 & 019

EXHIBIT B

1. Location

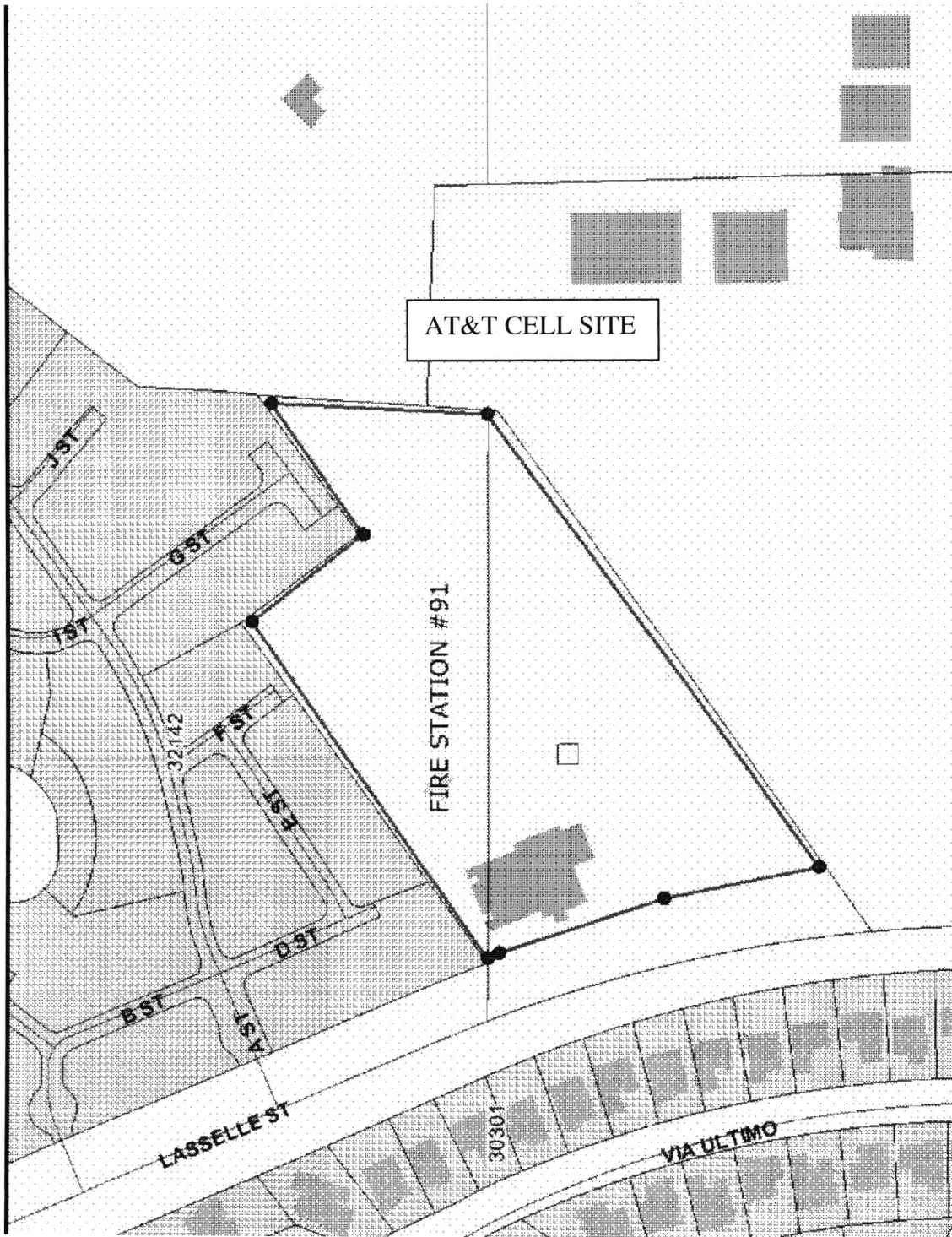

2. Licensee's Facilities

The project consists of the installation of 12 panel antennas, 24 RRU's, 4 surge suppressors, and one microwave dish, mounted to one new 60 foot mono-pine communication tower. A new building measuring approximately 20 feet by 12 feet with interior power and Telco panels.

License area: Approximately 1,213 sq ft.

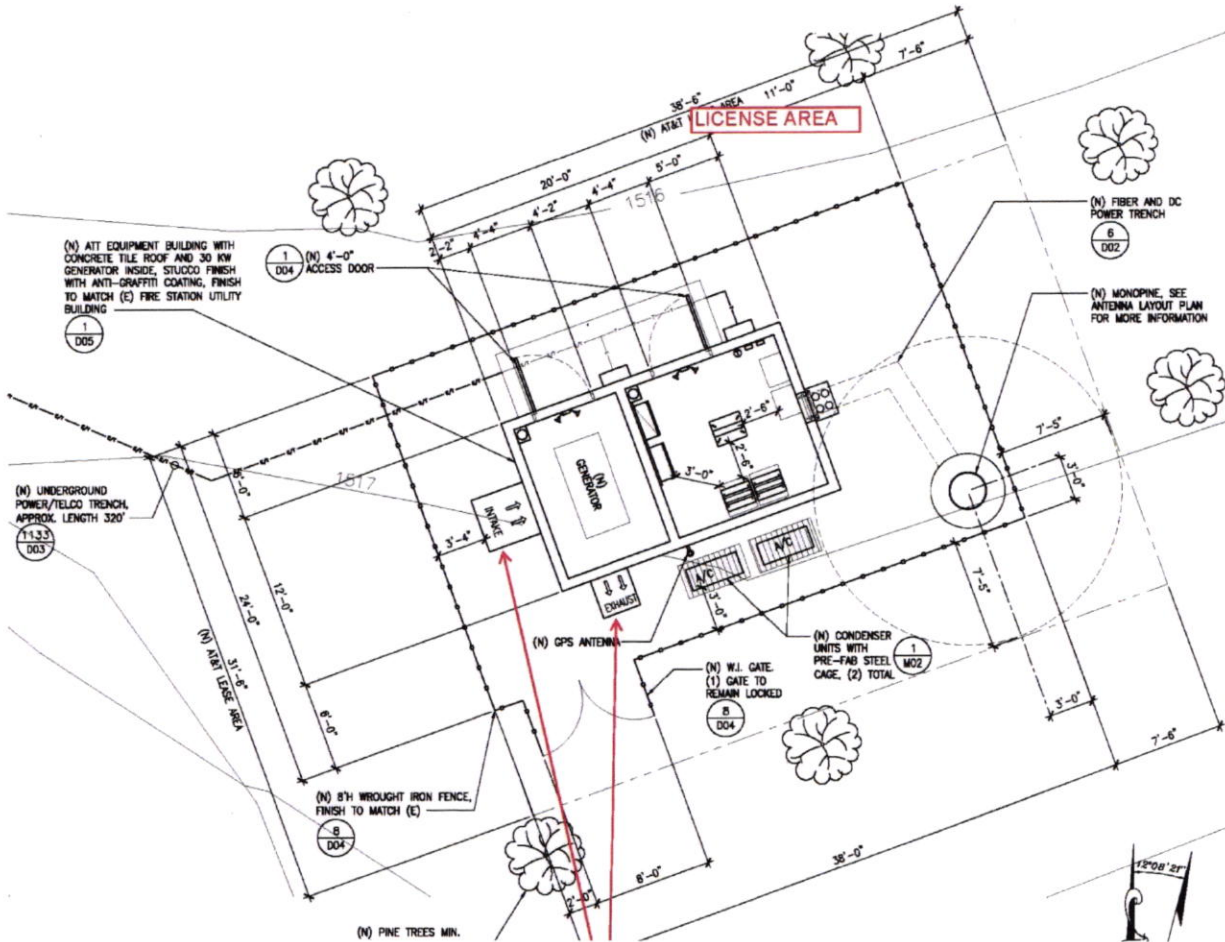

3. Incorporation of Plans by Reference

Construction drawings as approved by Building and Safety Division.

Attachment: TLA WITH NEW CINGULAR WIRELESS PCS AT FIRE STATION 91 PartExe (2846 : TELECOMMUNICATIONS LICENSE AGREEMENT

EXHIBIT "C"

Conditional Use Permit and Conditions of Approval by reference. Conditional Use Permit (CUP) #PA14-0005 was approved by the Planning Commission in October 2014.



Report to City Council

TO: Mayor and City Council

FROM: Joel Ontiveros, Chief of Police

AGENDA DATE: December 19, 2017

TITLE: APPROVAL FOR THE USE OF ASSET FORFEITURE FUNDS TO PURCHASE EQUIPMENT FOR THE POLICE DEPARTMENT TRAFFIC DIVISION

RECOMMENDED ACTION

Recommendations:

1. Authorize the police department to purchase 12 new Kustom Signals, Inc., Pro Laser IV, infrared LIDAR systems, at a cost of \$32,300.64 (\$29,940.00 for the LIDAR's & shipping, plus \$2,360.64 sales tax).
2. Authorize the police department to purchase 12 new Getac tablets to be used on the patrol motorcycles as a Mobile Dispatch Computer (MDC) and as an electronic ticket writer at a cost of \$39,081.91 (\$36,721.80 for the equipment, all related accessories and "e-waste" fees, plus \$2,360.11 sales tax).
3. Authorize a budget adjustment of \$71,383 to the General Fund (1010) Asset Forfeiture revenue account and the Traffic Enforcement expenditure account within the Police Department.

SUMMARY

This report recommends the City Council authorize the Moreno Valley Police Department to purchase 12 new Kustom Signals, Inc., Pro Laser IV, infrared LIDAR systems, and 12 new Getac tablets. The police department will utilize \$71,382.55 of asset forfeiture funds to acquire this equipment to be used toward increasing officer safety and efficiency with a goal of enhancing driver and pedestrian safety in the City of Moreno Valley.

DISCUSSION

LIDAR:

The police department traffic division currently deploys the Kustom Signal, Inc., Pro Laser III infrared LIDAR system. The LIDAR's were purchased approximately 10 years ago, and have exceeded their anticipated life expectancy.

The traffic division currently assigns LIDAR's to all motorcycle officers as well as all sworn accident investigators. The LIDAR's are used on a daily basis as a tool for the enforcement of speed laws. As a whole, the police department issued 5,992 citations for speed violations between July 1, 2016 and June 30, 2017. Of the 5,992 citations 5,394 (90%) were issued by members of the traffic division utilizing LIDAR.

Excessive speed has been identified as the primary collision factor in approximately 22% of all injury traffic collisions between July 1, 2016 and June 30, 2017. In addition to being a significant cause of injury traffic collisions, excessive speed increases the risk of serious or fatal injuries. The enforcement of speed laws is essential in ensuring the safety of roadways and this is best accomplished through the use of LIDAR.

The current LIDAR system deployed by the traffic division has been a valuable asset to the department; however, due to the age of the equipment they are no longer cost effective to operate and have exceeded their life expectancy. Several of the LIDAR's have become inoperable. For example, several LIDAR units have recently had battery and display malfunctions. These malfunctions include extremely short battery life, which is often less than an entire shift and the display being visible intermittently. In evaluating the most beneficial means of resolving these issues, it was determined the value associated with replacing the older LIDAR systems far outweighed the minimal savings achieved through repairs and refurbishment if available.

GETAC TABLETS:

Approximately five years ago, the traffic division was equipped with 15 electronic ticket writers. These devices were issued to all motorcycle officers, which allowed officers to issue citations more efficiently and obtain file numbers without utilizing the police radio.

During the last year, 11 electronic ticket writers have suffered catastrophic failures. Due to the age of the equipment and the manufacturer no longer producing this particular model, these devices cannot be repaired.

The proposed Getac tablet is similar to new tablets currently being installed in the patrol vehicles. The only difference, the requested tablets are smaller, for use on the patrol motorcycle. The tablet was recently tested and found to be completely compatible with the radio system and is the only authorized Mobile Dispatch Computer (MDC) for the motorcycle enforcement officers throughout the sheriff's department.

ALTERNATIVES

1. Authorize the police department to purchase 12 new Kustom Signals, Inc., Pro

Laser IV, infrared LIDAR systems, and 12 new Getac tablets utilizing \$71,383 of asset forfeiture funds to acquire this equipment and approve budget adjustments as set forth in the Fiscal Impact section of this report. Staff recommends this alternative.

2. Do not authorize the purchase of equipment and proposed budget adjustment. Failure to authorize the police department to make these purchases will directly impact the ability of the traffic division to enforce speed laws and issue citations within a timely manner. Staff does not recommend this alternative.

FISCAL IMPACT

The MVPD is requesting City Council to approve using asset forfeiture funding held by the County of Riverside to purchase the LIDAR systems and Getac tablets. Funding for this purchase will, if approved, not have any impact on the City’s General Fund budget. The budget appropriation will be as follows:

| Description | Fund | GL Account No. | Type (Rev/Exp) | FY 17/18 Budget | FY 17/18 Proposed Amendment | FY 17/18 Amended Budget |
|--|-----------|-------------------------|----------------|-----------------|-----------------------------|-------------------------|
| Asset Forfeiture Revenue (from County) | Gen. Fund | 1010-60-65-40010-480150 | Rev | \$0 | \$71,383 | \$71,383 |
| LIDAR and Getac Equipment | Gen. Fund | 1010-60-67-40210-630330 | Exp | \$0 | \$71,383 | \$71,383 |

PREPARATION OF STAFF REPORT

Prepared By:
Jaime Hernandez
Sergeant

Department Head Approval:
Joel Ontiveros
Chief of Police

Concurred By:
Dave Lelevier
Lieutenant

Concurred By:
Felicia London
Public Safety Contracts Administrator

CITY COUNCIL GOALS

Public Safety. Provide a safe and secure environment for people and property in the community, control the number and severity of fire and hazardous material incidents, and provide protection for citizens who live, work and visit the City of Moreno Valley.

CITY COUNCIL STRATEGIC PRIORITIES

1. Economic Development
2. Public Safety
3. Library
4. Infrastructure
5. Beautification, Community Engagement, and Quality of Life
6. Youth Programs

ATTACHMENTS

- 1. LIDAR Quote #1
- 2. LIDAR Quote #2
- 3. LIDAR Quote #3
- 4. GETAC Tablets Quote
- 5. GST_Getac Tablet_Sole Source - Signed

APPROVALS

| | | |
|-------------------------|-------------------|-------------------|
| Budget Officer Approval | <u>✓ Approved</u> | 11/20/17 10:20 AM |
| City Attorney Approval | <u>✓ Approved</u> | 11/22/17 5:21 PM |
| City Manager Approval | <u>✓ Approved</u> | 12/07/17 2:05 PM |

Quotation



KUSTOM SIGNALS, INC.

9652 Loiret Blvd, Lenexa, KS 66219-2406
 913-492-1400 Fax 913-492-1703
 sales@kustomsignals.com www.kustomsignals.com

Date 10/12/2017

To... RAFAEL LOPEZ
 RIVERSIDE CO SHERIFF'S OFFICE

 22850 CALLE SAN JUAN DE LOS LOGOS
 MORENO VALLEY CA 92552

Quote # 811981791412PC
 Terms Per Approved Terms
 This Quote Expires on 01/10/2018
 Phone 951-486-6700
 Fax 951-413-3141

| Qty | Product Description | UnitPrice | SubTotal |
|--------------|---|------------|--------------------|
| 12 | ProLaser 4 bundle includes a Hogue grip, 8 AA rechargeable batteries with charger (4 of which are spares), USB to PC interface cable, 12 VDC to USB adapter, hard carry case. | \$2,459.00 | \$29,508.00 |
| 12 | SHIPPING & HANDLING COSTS | \$36.00 | \$432.00 |
| 12 | 8% Sales Tax | \$196.72 | \$2,360.64 |
| Total | | | \$32,300.64 |

Signature

* Applicable Sales Tax Not Included. Seller may charge Buyer a 25% restocking fee.

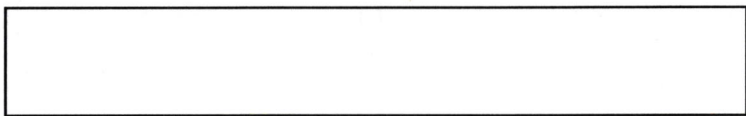

Toll Free 800-4KUSTOM (800-458-7866)

Attachment: LIDAR Quote #1 (2876 : APPROVAL FOR THE USE OF ASSET FORFEITURE FUNDS TO PURCHASE EQUIPMENT FOR THE POLICE

**KUSTOM SIGNALS, INC.
TERMS AND CONDITIONS**

1. **APPLICABILITY.** Unless otherwise specified in a written bid, quote or contract, the following terms and conditions shall apply.

2. **PRICES AND TAXES.** Prices will be Kustom Signals, Inc.'s ("Seller") prices in effect on the date a purchase order is accepted by Seller, and Seller may change its prices at any time, in its sole discretion. All prices will be F.O.B. Chanute, Kansas, and net of any duties, sales, use or similar taxes, fees or assessments, and do not include shipping, packaging or any insurance costs, all of which are Buyer's responsibility.

3. **PAYMENT.** Unless otherwise provided on the face of the invoice, payment is to be paid in US dollars and in accordance with the Seller approved terms for Buyer. Partial payments are not permitted unless authorized in writing. Partial payments will be treated as non-payment. Each invoice is independent from shipping sequence and disputes relating to other invoices. Failure to pay an invoice within 30 days will be considered a default.

4. **DELIVERY AND PERFORMANCE.** Delivery dates are approximate. Seller disclaims all liability for late or partial delivery. Seller may deliver in such lots and at such times as is convenient for Seller.

5. **LOSS IN TRANSIT.** Risk of loss will pass to Buyer upon delivery of the goods to the carrier. In case of breakage or loss in transit, Buyer will have notation of same made on expense bill before paying freight. Seller may reject claims for shortages not made within 15 days of Buyer's receipt of the goods.

6. **TERMINATION, RESTOCKING CHARGES.** Buyer may terminate this purchase order for its convenience, in whole or in part, by written, faxed or telegraphic notice at any time. If Buyer terminates this purchase order for convenience, Buyer will be liable to Seller for Seller's reasonable costs incurred in the performance of this purchase order that Seller cannot mitigate. Unless otherwise agreed upon in advance in writing by Seller, Seller may charge Buyer a 25% restocking fee, if: (a) upon approval by Seller, the Buyer returns any non-defective goods covered by this invoice; or (b) prior to shipment, but after the goods are produced by Seller, Buyer cancels the order for the subject goods.

7. **WARRANTY.** Seller's warranty is provided separately.

8. **LIMITATION OF LIABILITY.** SELLER IS NOT LIABLE FOR ANY CONSEQUENTIAL, INDIRECT, OR INCIDENTAL DAMAGES, OR ANY LOST PROFITS OR LOST SAVINGS, EVEN IF A SELLER REPRESENTATIVE HAS BEEN ADVISED OF THE POSSIBILITY OF SUCH LOSS, DAMAGES, CLAIMS OR COSTS, NOR IS SELLER LIABLE FOR ANY CLAIM BY ANY THIRD PARTY. SELLER'S AGGREGATE LIABILITY UNDER OR IN CONNECTION WITH THIS PURCHASE ORDER IS LIMITED TO THE AMOUNT PAID FOR THE GOODS.

9. **INDEMNIFICATION.** Buyer will indemnify, defend and hold Seller harmless from all losses, damages, liabilities and costs, including attorneys' fees, incurred or sustained by Seller as a result of any third party claim made against Seller, including a claim by a customer of Buyer, arising from its negligent, reckless, willful, or intentional actions in marketing and reselling the goods.

10. **EXPORT RULES.** Exports and re-exports of the goods may be subject to United States export controls and sanctions administered by the U.S. Department of Commerce Bureau of Industry and Security under its Export Administration Regulations ("EAR"). Buyer shall comply with all laws, rules and regulations applicable to the export or re-export of goods including but not limited to EAR which includes, among other things, screening potential transactions against the U.S. Government's (i) list of prohibited end users, and (ii) list of prohibited countries. Buyer represents and warrants that (i) it has not been charged with, convicted of, or penalized for, any violation of EAR or any statute referenced in EAR §766.25, and (ii) it has not been notified by any government official of competent authority that it is under investigation for any violation of EAR or any statute referenced in EAR §766.25.

11. **MISCELLANEOUS.** These terms and conditions, together with any other written agreement between Buyer and Seller, if any: (i) are the exclusive statements of the parties with respect to the subject matter and supersedes any prior or contemporaneous communications; (ii) may not be amended except in writing executed by the parties and will prevail in any case where the terms of Buyer's purchase order or other communication are inconsistent; (iii) will be interpreted and enforced in accordance with the laws of the State of Kansas, without giving effect to principles of conflicts of law. These terms and conditions are: (1) solely for the benefit of the parties, and no provision of these terms and conditions will be deemed to confer upon any other person any remedy, claim, liability, reimbursement, cause of action or other right. Each party consents to the exclusive personal jurisdiction of the state and federal courts located in the State of Kansas for purposes of any suit, action or other proceeding arising out of this Agreement, waives any argument that venue in any such forum is not convenient and agrees that the venue of any litigation initiated by either of them in connection with this Agreement will be in either the District Court of Johnson County, Kansas, or the United States District Court, District of Kansas. If any provision of these terms and conditions is unenforceable, the remaining provisions will remain in effect. No waiver (whether by course of dealing or otherwise) is effective unless it is made in writing and signed by the party to be charged with such waiver. Unless otherwise specified in writing, notices must be given in writing by registered or certified mail, return receipt requested, addressed to:

Kustom Signals, Inc.
Attn: Sales Dept.
9652 Loiret
Lenexa, KS 66219



LAKOTA CONTRACTING, INC.

1600 MT. VIEW STE. 106
 RAPID CITY, SD 57702
 FEIN: 46-0451565 DUNS: 002580780
 PH: 800-984-8550 Fax: 605-348-4113

QUOTE

| | |
|-----------|-----------|
| DATE | QUOTE NO. |
| 11/8/2017 | 0031920 |

| NAME / ADDRESS |
|---|
| RIVERSIDE COUNTY SHERIFF'S OFFICE RAFAEL LOPEZ 22850 CALLE SAN JUAN DE LOS LOGOS MORENO VALLEY, CA 92552 |

| SHIP TO |
|---|
| RIVERSIDE COUNTY SHERIFF'S OFFICE RAFAEL LOPEZ 22850 CALLE SAN JUAN DE LOS LOGOS MORENO VALLEY, CA 92552 |

| DELIVERY | FOB | Terms | Rep | DATE EXPIRES |
|-------------|-------------|-----------|-------|--------------|
| 35 DAYS ARO | DESTINATION | NET 30/CC | MARTY | 12/8/2017 |

| ITEM NO. | DESCRIPTION | QTY | COST | CLASS | TOTAL |
|----------|---|-----|----------|-------------|-----------|
| CRS 2000 | PROLASER 4 LIDAR BUNDLE. INCLUDES HOGUE GRIP, 8 AA RECHARGEABLE BATTERIES (4 OF WHICH ARE SPARES), USB TO PC INTERFACE CABLE, 12 VDC TO USB ADAPTER CABLE, HARD CARRY CASE AND 3 YEAR FACTORY WARRANTY. | 12 | 2,695.00 | SIN# 426-4Q | 32,340.00 |
| TAX | 8% SALES TAX | 1 | 2,587.20 | OPEN MAR... | 2,587.20 |

Business Size: Small/"Buy Indian" Certified
 Cage Code: 1VVC4
 GSA Contract#: GS-07F-0192N (Current thru 12/31/17)
 Sam Regist: Active thru 13JUL18
 www.lakotainc.com

| | |
|--------------|-------------|
| TOTAL | \$34,927.20 |
|--------------|-------------|

SIGNATURE _____

Attachment: LIDAR Quote #2 (2876 : APPROVAL FOR THE USE OF ASSET FORFEITURE FUNDS TO PURCHASE EQUIPMENT FOR THE POLICE



1337 Walker Lane
 Corona, CA 92879
 www.gstes.com
 951-340-2669

01 - GETAC



Prepared by:
Golden Star Technology - IE
 Cherri Dodson
 (951) 340-2669
 Fax 951-340-2671
 cdodson@gstes.com

Prepared for:
City of Moreno Valley
 22850 CALLE SAN JUAN DE LOS LAGOS POLICE
 DEPT.
 Moreno Valley, CA 92552
 Ralph Lopez
 rzlopez@riversidesheriff.org

Quote Information:
Quote #: 021286
 Version: 1
 Quote Date: 10/13/2017
 Expiration Date: 01/10/2018

Hardware

| Line | Item | Description | Price | Qty | Ext. Price | Taxable |
|------|--------------|--|------------|-----|-------------|-------------------------------------|
| 1 | TD98Z2GA5GXF | T800 G2 Premium USA - Intel Atom Processor x7-Z8750, 8.1"+Webcam, Microsoft Windows 10 Professional x64 with default RAM 8GB, 128GB eMMC, Sunlight Readable (LCD+Dual mode Touchscreen and Digitizer), Multi Language+US Power, 8M Rear Camera, Wifi+BT+GPS+Gob | \$1,893.00 | 12 | \$22,716.00 | <input checked="" type="checkbox"/> |
| 2 | GDOFUA | Getac Cradle - Docking - Tablet PC - Charging Capability | \$321.00 | 12 | \$3,852.00 | <input checked="" type="checkbox"/> |
| 3 | GE-SVCRNFX5Y | Getac Bumper-to-Bumper - 5 Year Extended Warranty - Warranty - Maintenance - Parts & Labor - Physical Service | \$517.40 | 12 | \$6,208.80 | <input type="checkbox"/> |
| 4 | GBS4X1 | Getac SnapBack Add-on: Extended Battery - 2100 mAh | \$146.00 | 12 | \$1,752.00 | <input checked="" type="checkbox"/> |
| 5 | GMPDX2 | Getac Digitizer pen - Tablet Device Supported | \$44.00 | 12 | \$528.00 | <input checked="" type="checkbox"/> |

NO RETURNS ALL SALES ARE FINAL
STANDARD ETA IS ABOUT 2-4 WEEKS OUT

| | | | | | | |
|---|--------|---|---------|----|------------|-------------------------------------|
| 6 | GMHSX9 | Getac Hand Strap | \$44.00 | 12 | \$528.00 | <input checked="" type="checkbox"/> |
| 7 | GAD1L1 | Getac Auto Adapter - 12 V DC Input Voltage | \$89.75 | 12 | \$1,077.00 | <input checked="" type="checkbox"/> |

Subtotal: \$36,661.80

Attachment: GETAC Tablets Quote (2876) : APPROVAL FOR THE USE OF ASSET FORFEITURE FUNDS TO PURCHASE EQUIPMENT FOR THE



1337 Walker Lane
Corona, CA 92879
www.gstes.com
951-340-2669

E-Waste 2017

| Line | Item | Description | Price | Qty | Ext. Price | Taxable |
|------|--------------|---|--------|-----|------------|--------------------------|
| 1 | E-Waste-4-14 | More than 4 inches but less than 15 inches | \$5.00 | 12 | \$60.00 | <input type="checkbox"/> |

Subtotal: \$60.00

Shipping

| Line | Item | Description | Price | Qty | Ext. Price | Taxable |
|------|--------------|---------------------|--------|-----|------------|--------------------------|
| 1 | GST-SHIPPING | GST-SHIPPING | \$0.00 | 1 | \$0.00 | <input type="checkbox"/> |

Quote Summary

| Description | Amount |
|--------------|-------------|
| Hardware | \$36,661.80 |
| E-Waste 2017 | \$60.00 |

Subtotal: \$36,721.80

Tax: \$2,360.11

Total: \$39,081.91

TERMS AND CONDITIONS

All prices and descriptions are subject to change without notice.

THIS PRICE LIST IS A QUOTATION ONLY AND IS NOT AN ORDER OR OFFER TO SELL. No contract for sale will exist unless and until a purchase order has been issued by you and accepted by Golden Star Technology Inc. ("GST"). Acceptance by GST of any offer is expressly conditioned upon your assent to the Terms and Conditions of Sale set forth in GST's invoices.

The prices contained in this list may not be relied upon as the price at which GST will accept an offer to purchase products unless expressly agreed to by GST in writing. Products quoted were selected by GST based on specifications available at the time of the quotation, and are not guaranteed to meet bid specifications. Product specifications may be changed by the manufacturer without notice. It is your responsibility to verify product conformance to specifications of any subsequent contract. All products are subject to availability from the manufacturer. The freight costs listed are estimates. Shipping costs may vary based on time of purchase, quantity ordered, shipment carrier and warehouse sourced. Actual shipping costs will be calculated during shipment and will be reflected on your invoice. For hardware product(s), manufacturer warranty will begin upon physical delivery of the hardware products(by) by the customer or GST warehouse. For software product(s), the manufacturer warranty will begin upon electronic or physical receipt of the software product(s) by you or GST.

GST is not responsible for compliance with regulations, requirements or obligations associated with any contract resulting from this quotation unless said regulations, requirements or obligations have been passed to GST and approved in writing by an authorized representative of GST.

Attachment: GETAC Tablets Quote (2876 : APPROVAL FOR THE USE OF ASSET FORFEITURE FUNDS TO PURCHASE EQUIPMENT FOR THE



1337 Walker Lane
Corona, CA 92879
www.gstes.com
951-340-2669

Customer Signature

Date

Attachment: GETAC Tablets Quote (2876 : APPROVAL FOR THE USE OF ASSET FORFEITURE FUNDS TO PURCHASE EQUIPMENT FOR THE

P.O. NO. _____

SOLE SOURCE REQUEST JUSTIFICATION/APPROVAL FORM

VENDOR NAME: Golden Star Technology - IE
CONTACT NAME: Cherri Dodson
PHONE NO: (951) 340-2669

Describe the product/service: The police department is looking to purchase tablets manufactured by Getac. The tablet (model T-800) will be used by motorcycle officers within the traffic team as a Mobile Dispatch Computer (MDC) and as an electronic ticket writer.

Check the reason for this sole source request:

1. No other vendor possesses the item(s) or service(s) needed to perform the same function as verified by research via the Internet and Yellow Pages.
 - A geographical territory exists of this dealer or distributor.
 - Proprietary: The item is sold exclusively by this vendor and held under exclusive title, trademark or copyright and no other vendor, dealer or distributor exists.
 - Geographic location: Transportation costs make purchasing from another vendor too costly.
 - Standardization: The City requires the product/service to be standardized based on parts, design, quality, inter-operability, expertise or other. Please explain: The tablets will be connected to the Riverside County Sheriff's network. Based on an extensive test and evaluation phase by the sheriff's department, it was decided Getac tablets is the sole authorized manufacturer of tablets connected to the sheriff's network. This was based on the fact the Getac meets or exceeds CJIS (Criminal Justice Information Services), which is a standard set by the Federal Bureau of Investigations (FBI) for the transmission of confidential information.
2. Is the product or service available from other sources? YES NO
 If YES, list names of vendors and explain why additional quotes were not obtained: No other quotes were obtained because the sole vender utilized by the Riverside County Sheriff's Department for the purchase of Getac tablets is Golden Star Technology - IE. Based on this fact, the sheriff's department has negotiated lower rates for the purchase of tablets, which will benefit the city of Moreno Valley.
3. Can your requirements be modified so that competitive products or services may be used?
- NO YES - Please explain: The Riverside County Sheriff's Department has developed a specification sheet for the purchase of Getac T-800 tablet, which are to be connected to the sheriff's network. In order for any Getac tablet to be connected to the Riverside County Sheriff's Department network, no modifications can be made.

P.O. NO. _____

Signatures: When signing below you are stating that the above is correct and true.

Division Manager Name: L. Tyler Clark

Division Manager Signature: [Signature] Date: 11/15/17

Approved: YES NO

Purchasing Manager: [Signature] Date: 11/16/17

Attachment: GST_Getac Tablet_Sole Source - Signed (2876 : APPROVAL FOR THE USE OF ASSET FORFEITURE FUNDS TO PURCHASE



Report to City Council

TO: Mayor and City Council

FROM: Abdul Ahmad, Fire Chief

AGENDA DATE: December 19, 2017

TITLE: AMENDMENT TO THE EXISTING CONTRACT WITH INLAND EMPIRE PROPERTY SERVICE, INC. FOR ON-SITE/OR PROFESSIONAL SERVICES FOR HAZARD ABATEMENT

RECOMMENDED ACTION

Recommendation:

1. Approve an amendment to the existing contract with Inland Empire Property Service, Inc. for Hazard Abatement Services not to exceed \$150,000 per year with a maximum contract of \$750,000.
2. Authorize the City Manager to execute the Agreement with Inland Empire Property Service, Inc.
3. Authorize a change order in the amount of \$75,000 to the purchase order for Inland Empire Property Service, Inc. for Fiscal Year 2017/2018, not to exceed a total of \$150,000.
4. Authorize the City Manager to approve the annual purchase order for the remaining four years of Inland Empire Property Service, Inc. contract, not to exceed \$150,000 for each year.
5. Authorize the Chief Financial Officer to appropriate an additional \$75,000 as revenue and expense in the General Fund (Fund 1010) Nuisance Abatement Account for FY 2017/18 and FY 2018/19.

SUMMARY

This report recommends amendment within the existing contract with Inland Empire Property Service, Inc. to provide hazard abatement services. Costs for hazard

abatement services conducted by Inland Empire Property Service Inc. are recovered from the property owner through the County Assessor's office.

DISCUSSION

In June 2017, the City Council approved a contract with Inland Empire Property Service Inc. to provide hazard abatement services. This contract is limited to \$75,000 per year with a five-year maximum of \$375,000. Due to higher than normal rainfall throughout the spring and unexpected amount of growth on vacant lands, the cost of abatement and the number of unabated lands was much higher than expected. On average, Inland Empire Service, Inc. abates 85 parcels on behalf of the city. In 2017, Inland Empire Service, Inc. has abated 380 parcels. To date, the fire department has expended the current contract amount in Fiscal Year 2017/2018 and is anticipating further abatements necessary this fiscal year. The Fire Department is requesting an amendment to the contract to reflect the increase in abatement costs. The proposed changes by staff are to:

- 1) Increase the annual purchase order amount to Inland Empire Property Service Inc. from \$75,000 to \$150,000
- 2) Increase the five-year maximum allowed by the contract from \$375,000 to \$750,000

The remainder of the contract remains intact and enforceable.

ALTERNATIVES

1. Approve an amendment to the existing five year Independent Contractor Agreement with Inland Empire Property Service Inc. for Hazard Abatement Services not to exceed \$750,000; authorize the City Manager to execute the Agreement with Inland Empire Property Service Inc. in the form attached hereto; and authorize the City Manager to approve the annual purchase orders issued to Inland Empire Property Service Inc.; authorize the Chief Financial Officer to appropriate an additional \$75,000 to the revenue and expense account for FY 2017/18 and FY 2018/19.
2. Do not approve an amendment to the existing five year Independent Contractor Agreement with Inland Empire Property Service Inc. for Hazard Abatement Services not to exceed \$750,000; do not authorize the City Manager to execute the Agreement with Inland Empire Property Service Inc. in the form attached hereto; and do not authorize the City Manager to approve the annual purchase orders issued to Inland Empire Property Service Inc.; do not authorize the Chief Financial Officer to appropriate an additional \$75,000 to the revenue and expense account for FY 2017/18 and FY 2018/19.

FISCAL IMPACT

Costs for hazard abatement services conducted by Inland Empire Property Service Inc. are recovered from the property owner through the County Assessor's office. Each year, a list of non-compliant parcels is sent to the County Assessor's office and results in a special assessment and becomes a levy on the next fiscal year's tax bill if not paid directly to the City prior to July 1 of that year. These fees, which are adopted annually by City Council action, are the actual contractor costs plus an administrative fee of \$240.00, an inspection fee of \$150.00, and a Special Districts fee of \$16.00.

The Fire Department is requesting City Council approval to appropriate an additional \$75,000 in revenue and expenditures to cover the Nuisance Abatement costs through the remaining FY 2017/18 and FY 2018/19. The budget appropriation will be as follows:

Revenue/Expenditure Appropriation:

| GL Account (GL) | Type | FY17/18 and FY18/19 Adopted Budget | Proposed Adjustment | FY17/18 and FY18/19 Amended Budget |
|------------------------------|------|---|------------------------|---|
| GL – 1010-40-46-30211-501030 | Rev | \$69,000 | \$75,000 | \$144,000 |
| GL – 1010-40-46-30211-625015 | Exp | \$75,000 | \$75,000 | \$150,000 |

NOTIFICATION

Not Applicable

PREPARATION OF STAFF REPORT

Prepared By:
Adria Reinertson
Fire Marshal

Department Head Approval:
Abdul Ahmad
Fire Chief

Concurred By:
Felicia London
Public Safety Contracts Administrator

CITY COUNCIL GOALS

Public Safety. Provide a safe and secure environment for people and property in the community, control the number and severity of fire and hazardous material incidents, and provide protection for citizens who live, work and visit the City of Moreno Valley.

CITY COUNCIL STRATEGIC PRIORITIES

1. Economic Development
2. Public Safety
3. Library
4. Infrastructure

- 5. Beautification, Community Engagement, and Quality of Life
- 6. Youth Programs

ATTACHMENTS

- 1. Inland Services amendment

APPROVALS

| | | |
|-------------------------|-------------------|------------------|
| Budget Officer Approval | <u>✓ Approved</u> | 12/07/17 2:39 PM |
| City Attorney Approval | <u>✓ Approved</u> | 12/07/17 4:13 PM |
| City Manager Approval | <u>✓ Approved</u> | 12/07/17 4:42 PM |

FIRST AMENDMENT TO THE AGREEMENT FOR PROFESSIONAL SERVICES

This is the First Amendment (“Amendment”) to the Agreement for Professional Services (“Agreement”) effective the 19th day of December, 2017, between CITY OF MORENO VALLEY (“City”) and Inland Empire Property Services Inc. (“Contractor”) entered into on July 1st, 2017.

RECITALS

WHEREAS, the original scope of work exceeded expectations of both parties and additional funding is necessary for Contractor to fully perform the necessary services under the Agreement.

NOW THEREFORE, in consideration of mutual covenants and promises received and contained in the Agreement, City and Contractor agree to the following amendment:

1. Exhibit C of the Agreement is hereby replaced with the Exhibit C attached to this Amendment and incorporated fully herein, with the intent to increase the annual “not to exceed” funding under the Agreement to \$150,000.
2. All other terms and conditions of the Agreement not affected by the Amendment remain in full force and effect.

IN WITNESS WHEREOF, Parties have entered into this Amendment as of the date set forth above.

City of Moreno Valley

Inland Empire Property Services, Inc.

BY: _____
City Manager

BY: _____

TITLE: _____
(President or Vice President)

Date

Date

BY: _____

TITLE: _____
(Corporate Secretary)

Date

Attachment: Inland Services amendment (2906 : AMENDMENT TO THE EXISTING CONTRACT WITH INLAND EMPIRE PROPERTY SERVICE,

INTERNAL USE ONLY

APPROVED AS TO LEGAL FORM:

City Attorney

Date

EXHIBIT C

TERMS OF PAYMENT

1. The Contractor's compensation shall not exceed **\$750,000.00 for the term of the agreement (\$150,000.00 per year for the term of the agreement)**.
2. The Contractor will obtain, and keep current during the term of this Agreement, the required City of Moreno Valley business license. Proof of a current City of Moreno Valley business license will be required prior to any payments by the City. Any invoice not paid because the proof of a current City of Moreno Valley business license has not been provided will not incur any fees, late charges, or other penalties. Complete instructions for obtaining a City of Moreno Valley business license are located at: http://www.moval.org/do_biz/biz-license.shtml
3. The Contractor will electronically submit an invoice to the City on a monthly basis for progress payments along with documentation evidencing services completed to date. The progress payment is based on actual time and materials expended in furnishing authorized professional services since the last invoice. At no time will the City pay for more services than have been satisfactorily completed and the City's determination of the amount due for any progress payment shall be final. The Contractor will submit all original invoices to Accounts Payable staff at AccountsPayable@moval.org

Accounts Payable questions can be directed to (951) 413-3073.

Copies of invoices may be submitted to the **Fire Prevention Division** at **fireprevention@moval.org** or calls directed to **(951) 413-3370**.
4. The Contractor agrees that City payments will be received via Automated Clearing House (ACH) Direct Deposit and that the required ACH Authorization form will be completed prior to any payments by the City. Any invoice not paid because the completed ACH Authorization Form has not been provided will not incur any fees, late charges, or other penalties. The ACH Authorization Form is located at:
http://www.moval.org/city_hall/forms.shtml#bf
5. The minimum information required on all invoices is:
 - A. Vendor Name, Mailing Address, and Phone Number
 - B. Invoice Date
 - C. Vendor Invoice Number
 - D. City-provided Reference Number (e.g. Project, Activity)

- E. Detailed work hours by class title (e.g. Manager, Technician, or Specialist), services performed and rates, explicit portion of a contract amount, or detailed billing information that is sufficient to justify the invoice amount; single, lump amounts without detail are not acceptable.
6. The City shall pay the Contractor for all invoiced, authorized professional services within thirty (30) days of receipt of the invoice for same.
 7. Reimbursement for Expenses. Contractor shall not be reimbursed for any expenses unless authorized in writing by City.
 8. Maintenance and Inspection. Contractor shall maintain complete and accurate records with respect to all costs and expenses incurred under this Agreement. All such records shall be clearly identifiable. Contractor shall allow a representative of City during normal business hours to examine, audit, and make transcripts or copies of such records and any other documents created pursuant to this Agreement. Contractor shall allow inspection of all work, data, documents, proceedings, and activities related to the Agreement for a period of three (3) years from the date of final payment under this Agreement.



Report to City Council

TO: Mayor and City Council

FROM: Allen Brock, Community Development Director

AGENDA DATE: December 19, 2017

TITLE: A CITYWIDE MUNICIPAL CODE (TITLE 9) AMENDMENT ADDRESSING LAND USE REGULATIONS FOR ACCESSORY DWELLING

RECOMMENDED ACTION

Recommendations: That the City Council:

1. Certify that the proposed Municipal Code Amendment (PEN17-0115) is exempt under the California Environmental Quality Act (CEQA) in accordance with Section 15282(h) of the CEQA Guidelines which specifically exempts adoption of an ordinance regarding accessory dwelling units; and
2. Introduce Ordinance No. _____. An Ordinance of the City Council of the City of Moreno Valley, California, amending Title 9 of the City of Moreno Valley Municipal Code addressing Accessory Dwelling Units (ADUs) to ensure compliance with new State of California laws.

SUMMARY

The proposed development code amendments will modify provisions in Title 9 of Moreno Valley Municipal Code (MVMC) related to Second Dwelling Units to bring it into compliance with new state regulations set forth in Senate Bill SB 1069 and Assembly Bill AB 2299 signed by Governor Jerry Brown in September 2016. A key change in the proposed ordinance is a change of all references of "second dwelling units" to Accessory Dwelling Units (ADU). The intent of the new State law for ADUs was to remove barriers to development of ADUs and provide the public greater flexibility, opportunity and ease of access to housing supply options.

Amendments to the Municipal Code are not uncommon and occur from time to time to ensure city regulations remain current with State law.

Background

California Government Code Section 65852.2 regarding second dwelling units was enacted in 1982 to encourage the creation of second dwelling units. The State regulations have been amended previously to continue to remove potential barriers, with sufficient flexibility to address unique local circumstances and conditions.

On April 13, 2010, the Moreno Valley City Council adopted Ordinance 817 to modify the City's Title 9 development code provisions to ensure consistency with then amended Government Code Sections 65583.1, 65852.2, and 65915 required by the passage of Assembly Bill 186, making second dwelling units allowable by right and the permitting of such considered a "ministerial" action.

New State Accessory Dwelling Unit Law

New state regulations for second units included in Senate Bill SB 1069 and Assembly Bill AB 2299 approved in September 2016 became effective on January 1, 2017. These legislative actions effectively renamed second dwelling units to Accessory Dwelling Units (ADUs).

Assembly Bill AB 2299 provided that any existing local ordinance pertaining to ADUs that does not meet the Bill's intent and written requirements, is to be considered null and void as of January 1, 2017. In such cases, new applications for ADU's must then be processed in accordance with the State regulations until such time that the local jurisdiction adopts a compliant ordinance. The City's Code is currently in this status.

DISCUSSION

Project Description

To respond to State law changes, the following topics within the City's Code have been addressed:

1. The subject heading for Section 9.09.130 will be revised to "Accessory Dwelling Unit (ADU)";
2. Added new definitions for ADU and efficiency units;
3. Clarified land use determination and permit processing procedures;
4. Added development standards/provisions for efficiency units;
5. Added restrictions pertaining to fire safety;
6. Added utility connection fee restrictions;
7. Clarified ADU setbacks and separation requirements;

8. Added language covering parking exemptions; and
9. Included modifications to Table 9.11.040A-12 (Off-Street Parking Requirements) in Chapter 9.11 (Parking, Pedestrian and Load Requirements).

The specific details for each change are further shown in Attachment 1 to the staff report. In addition, and to facilitate consideration of the proposed changes, Attachment 2 is the existing zoning provisions for second dwelling units. Attachment 3 provides a “side-by-side” comparison table of the existing zoning and the proposed changes.

Three particularly noteworthy changes include:

1. Efficiency Units

The definition of efficiency units, as defined by Section 17958.1 of the Health and Safety Code, has been added. Efficiency units are for occupancy by no more than two persons, have a minimum floor area of 150 square feet and may also have partial kitchen or bathroom facilities. Under State law, the City cannot prohibit efficiency units; therefore, the new language of the proposed ordinance authorizes the Community Development Director to approve efficiency units administratively when it can be demonstrated by an applicant that all applicable development standards are met.

2. Parking

Presently, the MVMC requires one open parking space be provided per bedroom for an ADU. This provision will remain, however the new State law provides for parking exemptions that the City must follow. Therefore, new language is recommended to be added such that ADU parking requirements would be waived under any of the following five scenarios if requested by the applicant:

- (1) The accessory dwelling unit is located within one-half mile of public transit.
- (2) The accessory dwelling unit is located within an architecturally and historically significant historic district.
- (3) The accessory dwelling unit is part of the existing primary residence or an existing accessory structure.
- (4) When on-street parking permits are required but not offered to the occupant of the accessory dwelling unit.
- (5) When there is a car share vehicle located within one block of the accessory dwelling unit.

As a matter of process, it will be incumbent upon the applicant, within the permit submittal materials, to demonstrate to the satisfaction of the Community Development Director that one or more of the five criteria noted above do in fact apply. If none of the prerequisite conditions for the waiver are present, the project will be required to provide one uncovered parking space per bedroom for the ADU.

To ensure consistency within the MVMC, Table 9.11.040A-12 (Off-Street Parking Requirements) within Chapter 9.11 will be revised as follows to include an appropriate reference to the new provisions contained in Section 9.09.130:

| Residential Uses | Requirement | Covered Parking | Notes |
|--|-------------|-----------------|---|
| Second units Accessory Dwelling Unit | 1/bedroom | | The second dwelling unit shall provide a minimum of one parking space per bedroom in addition to the parking required for the main dwelling without blocking any required parking (no tandem parking). The Accessory Dwelling Unit shall provide a minimum of one parking space per bedroom in addition to the parking required for the main dwelling, except as exempted by State law (refer to 9.09.130 Accessory dwelling units). Spaces may be provided as uncovered and/or tandem parking on a driveway. |

3. Minimum and Maximum Unit Size

The MVMC currently establishes the minimum square footage for an ADU at four hundred fifty (450) square feet and a maximum size of one-thousand two-hundred fifty (1,250) square feet. The maximum square footage may be exempted in cases where the size of the existing primary dwelling unit is one-thousand two-hundred fifty (1,250) square feet or smaller. In those cases, the ADU may exceed one-thousand two-hundred fifty (1,250) square feet and the unit would be subject to the development standards for the zoning district. In order to achieve consistency with changes in the new State law these standards must be revised.

The proposed amendment will add a new provision that allows a minimum unit size for attached ADUs of one hundred and fifty (150) square feet consistent with the State law for efficiency units. The minimum size of four hundred fifty (450) square feet will remain for detached ADUs.

The new State law specifies the maximum size of an ADU to be one-thousand two-hundred (1,200) square feet, and for ADUs attached to an existing single family dwelling the ADU cannot be larger than 50% of the existing living areas. To ensure consistency with the new State law, the maximum square footage for detached ADUs within the MVMC will be reduced from one-thousand two-hundred fifty (1,250) to one-thousand two-hundred (1,200) square feet. The maximum square footage for attached ADUs will be limited to 50% of the existing living areas of the existing residence and in no event shall be greater than one-thousand two-hundred (1,200) square feet.

Additions to Section 9.15 (Definitions)

The proposed MVMC Section 9.09.130 Accessory Dwelling Units (ADU) includes the following new definitions, which will also be added to Section 9.15 (Definitions) of the MVMC:

- “Accessory dwelling unit” means an attached or a detached residential dwelling unit, which provides complete independent living facilities for one or more persons. It shall include permanent provisions for living, sleeping, eating, cooking, and sanitation on the same parcel that the existing single-family dwelling is situated.
- “Efficiency unit” means an attached unit for occupancy by no more than two persons which have a minimum floor area of 150 square feet and which may also have partial kitchen or bathroom facilities, as allowed in Section 17958.1 of the Health and Safety Code.

ADVISORY BOARD/COMMISSION RECOMMENDATION

The Planning Commission approved Resolution 2017-33 on October 26, 2017 by a 5-0 vote. The resolution recommends that the City Council approve the proposed amendments to Title 9 of the City Municipal Code related to Accessory Dwelling Units (ADUs).

At the October 26, 2017 Planning Commission meeting, Commissioners received a detailed written staff report (Attachment 4) and the staff presentation including an overview of the proposed Municipal Code Amendment.

During the public comments portion of the public hearing, one speaker spoke in favor of the proposed Municipal Code amendment stating that accessory dwelling units could be beneficial for larger, multi-generational families. One email was submitted to the Planning Commission by a resident that was unable to attend the public hearing (Attachment 5).

After additional discussion with staff, the Planning Commission took actions to recommend that the City Council approve the proposed amendment as provided (Attachment 6). This recommendation provides consistency with State enacted requirements in effect since January 1, 2017.

ENVIRONMENTAL

Staff has reviewed the proposed Municipal Code Amendment in accordance with the CEQA Guidelines and has determined that the proposed ordinance qualifies for a statutory exemption per Section 15282(h) of the California Environmental Quality Act (CEQA) Guidelines. The adoption of an ordinance regarding second units in a single-family or multiple-family residential zone by a city or county to implement the provisions

of Government Code Sections 65852.1 and 65852.2 is exempt from the requirements of CEQA.

ALTERNATIVES

1. Introduce the proposed Ordinance as submitted. Staff recommends this alternative to provide consistency with recently enacted State requirements.
2. Deny the proposed Ordinance. An action to deny the proposed ordinance would result in inconsistency between Title 9, related to Accessory Dwelling Units, and recently enacted State requirements. Staff does not recommend this alternative.

FISCAL IMPACT

Not applicable.

NOTIFICATION

In accordance with Section 9.02.200 of the Municipal Code, a 1/8 page public notice was published in the Press Enterprise newspaper on December 8, 2017 for the December 19, 2017 public hearing (Attachment 7).

PREPARATION OF STAFF REPORT

Prepared By:
Claudia Manrique
Associate Planner

Department Head Approval:
Allen Brock
Community Development Director

CITY COUNCIL GOALS

Community Image, Neighborhood Pride and Cleanliness. Promote a sense of community pride and foster an excellent image about our City by developing and executing programs which will result in quality development, enhanced neighborhood preservation efforts, including home rehabilitation and neighborhood restoration.

CITY COUNCIL STRATEGIC PRIORITIES

1. Economic Development
2. Public Safety
3. Library
4. Infrastructure
5. Beautification, Community Engagement, and Quality of Life
6. Youth Programs

ATTACHMENTS

- 1. Proposed MVMC Section 9.09.130
- 2. Existing MVMC Section 9.09.130
- 3. MVMC Section 9.09.130 Comparison Table
- 4. Planning Commission Staff Report
- 5. K.Dale Email 10-25-17
- 6. Planning Commission Hearing Minutes 10.26.17
- 7. Press Enterprise Newspaper Notice
- 8. Ordinance
- 9. Exhibit A - Proposed Section 9.09.130
- 10. Exhibit B - Parking Tables

APPROVALS

| | | |
|-------------------------|-------------------|------------------|
| Budget Officer Approval | <u>✓ Approved</u> | 11/27/17 7:28 AM |
| City Attorney Approval | <u>✓ Approved</u> | 11/28/17 3:32 PM |
| City Manager Approval | <u>✓ Approved</u> | 12/07/17 2:05 PM |

Exhibit A

9.09.130 Accessory Dwelling Units (ADU).

A. Purpose and Intent. The purpose of these standards is to ensure:

1. Accessory dwelling units (ADU) as defined herein are a permitted accessory use. This chapter establishes location and development standards for the construction and occupancy of accessory dwelling units on single-family residential lots. The standards herein serve to ensure accessory dwelling units are constructed in a manner that is consistent with the requirements and allowances of state law.

2. An accessory dwelling unit does not exceed the allowable density for a lot upon which an ADU is built. ADUs are a residential use that is consistent with the existing general plan and zoning designation.

B. Applicability. Each accessory dwelling unit (ADU) shall require approval of an administrative plot plan, and shall comply with the development standards for the district in which it is located and the provisions of this section.

C. Definitions.

For the purpose of this chapter, the following definitions shall apply unless the context clearly indicates or requires a different meaning.

1. "Accessory dwelling unit" means an attached or a detached residential dwelling unit, which provides complete independent living facilities for one or more persons. It shall include permanent provisions for living, sleeping, eating, cooking, and sanitation on the same parcel the existing single-family dwelling is situated.

2. "Efficiency unit" means a unit for occupancy by no more than two persons which have a minimum floor area of one-hundred fifty (150) square feet and which may also have partial kitchen or bathroom facilities, as allowed in Section 17958.1 of the Health and Safety Code.

D. Approval Authority.

Approval of an accessory dwelling unit is considered a ministerial action and the approval authority is the Community Development Director. Approval of an accessory dwelling unit is subject to all applicable requirements established within this chapter as well as all building, fire, engineering, flood, water quality, environmental codes, standards, and permitting fees established by the City.

E. Application and Processing.

1. ADU proposed within previously permitted existing space: Applications for an accessory dwelling unit to be established within an existing permitted space including,

the primary structure, an attached or detached garage or other accessory structure on the same property shall be made to the Community Development Department and shall be permitted ministerially with approval of both an Administrative Plot Plan and a building permit where all of the following have been submitted to the satisfaction of the Community Development Director:

- a. A detailed description and scaled, dimensioned floor plan of the proposed ADU, clearly illustrating the bedroom(s), bathroom(s), kitchen and other features or other proposed habitable areas;
- b. A detailed description and scaled, dimensioned elevation of the proposed ADU, clearly illustrating the exterior entrance of the ADU;
- c. A scaled, dimensioned site plan of the property clearly illustrating the location of all improvements on site (existing primary residence, garage, driveway(s), fences/walls, accessory structures, public right-of-way improvements, etc.) and where the ADU shall be located;
- d. The scaled, dimensioned site plan of the property shall note the use(s) of all buildings existing on site.

2. New ADU: Applications for an ADU not located within an existing permitted structure or dwelling shall be made to the Community Development Department and shall be permitted ministerially with approval of both an Administrative Plot Plan and building permit where all of the following have been submitted to the satisfaction of the Community Development Director:

- a. A detailed description and scaled, dimensioned floor plan of the proposed ADU, clearly illustrating the bedroom(s), bathroom(s), kitchen and other features or other proposed habitable areas;
- b. A detailed description and scaled, dimensioned elevation of the proposed ADU, clearly illustrating the exterior of the ADU;
- c. A scaled, dimensioned site plan of the property clearly illustrating the location of all improvements on site (existing primary residence, garage, driveway(s), fences/walls, accessory structures, public right-of-way improvements, etc.) and where the ADU shall be located;
- d. The scaled, dimensioned site plan of the property shall note the use(s) of all buildings existing on site.

3. Applications shall be permitted ministerially within 120 days of application if all applicable requirements and development standards of this chapter are met and no variances are required.

F. Development Standards and Requirements.

Accessory dwelling units shall comply with the following development standards:

1. The lot is zoned for single-family or multifamily use and contains an existing, single-family dwelling.
2. Only one ADU is allowed per lot/parcel.

3. The ADU must be on the same lot as the existing dwelling.
4. The ADU shall not be for sale separate from the primary residential dwelling on site, unless the land containing the second unit accessory dwelling unit (ADU) is first divided from the property containing the main unit in accordance with the city's subdivision regulations.
5. The applicant shall be the owner-occupant of the property and shall reside in either the primary residence or the ADU.
6. The minimum lot size for a parcel to be eligible for a detached accessory dwelling unit (ADU) shall be seven thousand two hundred (7,200) square feet. There is no minimum lot area required for an attached ADU.
7. Total lot coverage, including the ADU, shall be as permitted within the underlying zoning district. If no lot coverage is specified, the maximum lot coverage allowed is 50%.
8. The minimum square footage of a detached ADU shall be four hundred fifty (450) square feet. The unit shall include permanent provisions for living, sleeping, eating, cooking, and sanitation.
9. The maximum square footage of the ADU shall be no greater than one thousand two hundred (1,200) square feet, except when the primary dwelling unit is one thousand two hundred fifty (1,200) square feet or smaller. In that case, the ADU may exceed one thousand two hundred fifty (1,200) square feet subject to the development standards for the zoning district.
10. ADUs shall follow the development standards of the zone in which a lot is located, including but not limited to height, lot coverage, and setbacks.
11. Setbacks are not required for an existing garage that is converted to an ADU. An ADU that is constructed above a garage requires a five foot setback from the side and rear lot lines.
12. ADUs shall be located at the rear or the side of the existing single family dwelling unless it is demonstrated to the satisfaction of the Community Development Director that the ADU can only be located in front of the single family dwelling due to extraordinary or physical constraints of the lot.
13. The entrance to an attached ADU shall be separate from the entrance to the primary dwelling unit and shall be located/designed in a manner as to eliminate an obvious indication of two units in the same structure.

14. Plans that demonstrate an unobstructed pathway extending from a street to one entrance of the ADU are desirable prior to approval of an ADU application; however, is not a mandatory requirement for an ADU.

15. The unit shall have adequate water supply and sewage disposal capability.

16. ADUs, when converted from existing accessory structures, are permitted without additional restrictions provided the structure has independent exterior access and side and rear setbacks sufficient for fire safety.

17. ADUs shall be subject to all development fees specified by city ordinances or resolutions for ADUs.

18. Parking Requirements, consistent with Chapter 9.11 of this title:

- a. One parking space is required per bedroom of an Accessory Dwelling Unit and may be provided through tandem parking.
- b. Parking is allowed in rear and side setback areas. No parking is allowed in front setback areas.
- c. When a garage or covered parking structure is demolished in conjunction with the construction of an Accessory Dwelling Unit, the replacement parking spaces may be located in any configuration on the same lot as the Accessory Dwelling Unit, including but not limited to covered spaces, uncovered spaces, or tandem spaces. However, replacement parking will not be a mandatory requirement.

19. Parking Exemptions. Additional parking spaces are not required for Accessory Dwelling Units in any of the following instances:

- a. The ADU is located within one-half mile of a public transportation stop along a prescribed route according to a fixed schedule; or
- b. The ADU is located within one block of a car share parking spot; or
- c. The ADU is located in a historic district listed in or formally determined eligible for listing in the National Register of Historic Places and the California Register of Historical Resources or as a City Historic Preservation Overlay Zone; or
- d. When on-street parking permits are required but not offered to the occupant of the Accessory Dwelling Unit; or
- e. The Accessory Dwelling Unit is part of the existing Dwelling Unit or an existing accessory structure.

20. New detached or attached ADUs shall be compatible with the architectural style of the primary residence in design features. To determine architectural compatibility, the ADU must possess at least three of the following design elements in common with the primary building on the site:

- a. Wall covering materials (wood, stucco, metal);

- b. Wall texture (smooth, stucco, lace stucco, lap siding);
- c. Roofing material (tile, shake, composition, metal);
- d. Roof pitch;
- e. Structural eaves;
- f. Mass and scale of structure relative to structural height;
- g. Window characteristics (few or numerous, single pane, multi-pane, decorative);
and
- h. Decorative treatments (pop-outs, columns, dormers, window surrounds, decorative arches)

21. Outside stairways serving ADUs should not be located on any building elevation facing a public street; and when unavoidable, the design of the stairway shall mute/mitigate any potential negative aesthetic impact and maintain the character of the existing single family residence.

22. The property owner(s) shall enter into a written agreement with the city, in which the owner(s) agree to use the premises in compliance with the requirements of this section, any applicable enactments of the city council, and in form acceptable to the city attorney and the community development director. The written agreement shall include that any lease executed on an ADU shall automatically become a month to month tenancy at the time of sale or transfer of the property. Recordation of such agreement in the files of the county recorder shall be completed prior to issuance of a building permit for the ADU.

Attachment 2: Existing

9.09.130 Second dwelling units.

A. Purpose and Intent. The purpose of these standards is to ensure that accessory living quarters located in residential districts do not adversely impact either adjacent residential parcels or the surrounding neighborhood, and are developed in a manner which protects the integrity of the residential district, while providing for needed housing opportunities for owners of eligible parcels.

B. Applicability. Each second dwelling unit shall comply with the development standards for the district in which it is located, the provisions of this section, and shall require approval of an administrative plot plan.

C. Property Development Standards. The following standards shall apply to all second dwelling units:

1. No more than one second unit or other type of accessory dwelling unit shall be permitted per lot;
2. The lot must contain one, but no more than one existing dwelling unit;
3. The minimum lot size for a parcel to be eligible for a second dwelling unit shall be seven thousand two hundred (7,200) square feet;
4. The minimum square footage of a second dwelling unit shall be four hundred fifty (450) square feet. The maximum square footage of a second dwelling unit shall be no greater than one thousand two hundred fifty (1,250) square feet, except when the primary dwelling unit is one thousand two hundred fifty (1,250) square feet or smaller. In that case, the second unit may exceed one thousand two hundred fifty (1,250) square feet subject to the minimum development standards for the zoning district;
5. The unit shall be subject to the same minimum development standards as the main building on the parcel including building setbacks;
6. The second unit shall be compatible with the main dwelling unit in architecture, mass and scale;
7. The second dwelling unit shall provide a minimum of one parking space per bedroom in addition to the parking required for the main dwelling without blocking the required parking (no tandem parking) pursuant to Chapter 9.11 of this title;
8. The unit may be rented and shall not be sold separately from the main unit unless the land containing the second unit is first divided from the property containing the main unit in accordance with the city's subdivision regulations;
9. The unit shall have adequate water supply and sewage disposal capability;
10. The applicant shall be the owner-occupant of the property and shall reside in either the primary residence or the second unit;
11. The entrance to an attached second unit shall be separate from the entrance to the first unit and shall be installed in a manner as to eliminate an obvious indication of two units in the same structure;
12. Second units shall be subject to all development fees specified by city ordinances or resolutions for second units;
13. The unit shall have kitchen and bath facilities; and
14. The property owner(s) shall enter into a written agreement with the city, in which the owner(s) agree to use the premises in compliance with the requirements of

this section, any applicable enactments of the city council, and in form acceptable to the city attorney and the community development director. The written agreement shall include that any lease executed on a second dwelling unit shall automatically become a month to month tenancy at the time of sale or transfer of the property. Recordation of such agreement in the files of the county recorder shall be completed prior to issuance of a building permit for the second unit. (Ord. 912 § 20, 2016; Ord. 817 § 3.3, 2010; Ord. 475 § 1.4, 1995; Ord. 428 § 1.2, 1994; Ord. 359, 1992)

| Existing 9.09.130 Second dwelling units. | Proposed 9.09.130 Accessory dwelling units. |
|--|--|
| <p>A. Purpose and Intent. The purpose of these standards is to ensure that accessory living quarters located in residential districts do not adversely impact either adjacent residential parcels or the surrounding neighborhood, and are developed in a manner which protects the integrity of the residential district, while providing for needed housing opportunities for owners of eligible parcels.</p> | <p>A. Purpose and Intent. The purpose of these standards is to ensure:</p> <ol style="list-style-type: none"> 1. Accessory dwelling units (ADU) as defined herein are a permitted accessory use. This chapter establishes location and development standards for the construction and occupancy of accessory dwelling units on single-family residential lots. The standards herein serve to ensure accessory dwelling units are constructed in a manner that is consistent with the requirements and allowances of state law. 2. An accessory dwelling unit does not exceed the allowable density for a lot upon which an ADU is built. ADUs are a residential use that is consistent with the existing general plan and zoning designation. |
| <p>B. Applicability. Each second dwelling unit shall comply with the development standards for the district in which it is located, the provisions of this section, and shall require approval of an administrative plot plan.</p> | <p>B. Applicability. Each accessory dwelling unit (ADU) shall require approval of an administrative plot plan, and shall comply with the development standards for the district in which it is located and the provisions of this section.</p> |
| <p>C. Property Development Standards. The following standards shall apply to all second dwelling units:</p> <ol style="list-style-type: none"> 1. No more than one second unit or other type of accessory dwelling unit shall be permitted per lot; 2. The lot must contain one, but no more than one existing dwelling unit; 3. The minimum lot size for a parcel to be eligible for a second dwelling unit shall be seven thousand two hundred (7,200) square feet; 4. The minimum square footage of a second dwelling unit shall be four hundred fifty (450) square feet. The maximum square footage of a second dwelling unit shall be no greater than one thousand two hundred fifty (1,250) square feet, except when the primary dwelling unit is one thousand two hundred fifty (1,250) square feet or smaller. In that case, the second unit may exceed one thousand two hundred fifty (1,250) square feet subject to the minimum development standards for the zoning district; 5. The unit shall be subject to the same minimum development standards as the main building on the parcel including building setbacks; | <p>C. Definitions.</p> <p>For the purpose of this chapter, the following definitions shall apply unless the context clearly indicates or requires a different meaning.</p> <ol style="list-style-type: none"> 1. "Accessory dwelling unit" means an attached or a detached residential dwelling unit, which provides complete independent living facilities for one or more persons. It shall include permanent provisions for living, sleeping, eating, cooking, and sanitation on the same parcel the existing single-family dwelling is situated. 2. "Efficiency unit" means a unit for occupancy by no more than two persons which have a minimum floor area of one-hundred fifty (150) square feet and which may also have partial kitchen or bathroom facilities, as allowed in Section 17958.1 of the Health and Safety Code. |

6. The second unit shall be compatible with the main dwelling unit in architecture, mass and scale;

7. The second dwelling unit shall provide a minimum of one parking space per bedroom in addition to the parking required for the main dwelling without blocking the required parking (no tandem parking) pursuant to Chapter 9.11 of this title;

8. The unit may be rented and shall not be sold separately from the main unit unless the land containing the second unit is first divided from the property containing the main unit in accordance with the city's subdivision regulations;

9. The unit shall have adequate water supply and sewage disposal capability;

10. The applicant shall be the owner-occupant of the property and shall reside in either the primary residence or the second unit;

11. The entrance to an attached second unit shall be separate from the entrance to the first unit and shall be installed in a manner as to eliminate an obvious indication of two units in the same structure;

12. Second units shall be subject to all development fees specified by city ordinances or resolutions for second units;

13. The unit shall have kitchen and bath facilities; and

14. The property owner(s) shall enter into a written agreement with the city, in which the owner(s) agree to use the premises in compliance with the requirements of this section, any applicable enactments of the city council, and in form acceptable to the city attorney and the community development director. The written agreement shall include that any lease executed on a second dwelling unit shall automatically become a month to month tenancy at the time of sale or transfer of the property. Recordation of such agreement in the files of the county recorder shall be completed prior to issuance of a building permit for the second unit. (Ord. 912 § 20, 2016; Ord. 817 § 3.3, 2010; Ord. 475 § 1.4, 1995; Ord. 428 § 1.2, 1994; Ord. 359,

| | |
|-------|--|
| 1992) | |
| | <p>D. Approval Authority. Approval of an accessory dwelling unit is considered a ministerial action and the approval authority is the Community Development Director. Approval of an accessory dwelling unit is subject to all applicable requirements established within this chapter as well as all building, fire, engineering, flood, water quality, environmental codes, standards, and permitting fees established by the City.</p> |
| | <p>E. Application and Processing.</p> <ol style="list-style-type: none"> 1. ADU proposed within previously permitted existing space: Applications for an accessory dwelling unit to be established within an existing permitted space including, the primary structure, an attached or detached garage or other accessory structure on the same property shall be made to the Community Development Department and shall be permitted ministerially with approval of both an Administrative Plot Plan and a building permit where all of the following where all of the following have been submitted to the satisfaction of the Community Development Director: <ol style="list-style-type: none"> a. A detailed description and scaled, dimensioned floor plan of the proposed ADU, clearly illustrating the bedroom(s), bathroom(s), kitchen and other features or other proposed habitable areas; b. A detailed description and scaled, dimensioned elevation of the proposed ADU, clearly illustrating the exterior of the ADU; c. A scaled, dimensioned site plan of the property clearly illustrating the location of all improvements on site (existing primary residence, garage, driveway(s), fences/walls, accessory structures, public right-of-way improvements, etc.) and where the ADU shall be located; d. The scaled, dimensioned site plan of the property shall note the use(s) of all buildings existing on site. 2. New detached ADU: Applications for an ADU not located within an existing permitted structure or dwelling shall be made to the Community Development Department and shall be permitted ministerially with approval of both an Administrative Plot Plan and building permit where all of the following |

| | |
|--|---|
| | <p>have been submitted to the satisfaction of the Community Development Director:</p> <ul style="list-style-type: none">a. A detailed description and scaled, dimensioned floor plan of the proposed ADU, clearly illustrating the bedroom(s), bathroom(s), kitchen and other features or other proposed habitable areas;b. A detailed description and scaled, dimensioned elevation of the proposed ADU, clearly illustrating the exterior of the ADU;c. A scaled, dimensioned site plan of the property clearly illustrating the location of all improvements on site (existing primary residence, garage, driveway(s), fences/walls, accessory structures, public right-of-way improvements, etc.) and where the ADU shall be located;d. The scaled, dimensioned site plan of the property shall note the use(s) of all buildings existing on site. <p>3. Applications shall be permitted ministerially within 120 days of application if all applicable requirements and development standards of this chapter are met and no variances are required.</p> |
| | <p>F. Development Standards and Requirements. Accessory dwelling units shall comply with the following development standards:</p> <ul style="list-style-type: none">1. The lot is zoned for single-family or multifamily use and contains an existing, single-family dwelling.2. Only one ADU is allowed per lot/parcel.3. The ADU must be on the same lot as the existing dwelling.4. The ADU shall not be for sale separate from the primary residential dwelling on site, unless the land containing the second unit accessory dwelling unit (ADU) is first divided from the property containing the main unit in accordance with the city's subdivision regulations.5. The applicant shall be the owner-occupant of the property and shall reside in either the primary residence or the ADU.6. The minimum lot size for a parcel to be eligible for a detached accessory dwelling unit (ADU) shall be seven thousand two hundred (7,200) square feet. There is no minimum lot area required for an attached ADU.7. Total lot coverage, including the ADU, shall be as permitted within the underlying zoning district. If no |

| | |
|--|--|
| | <p>lot coverage is specified, the maximum lot coverage allowed is 50%.</p> <p>8. The minimum square footage of a detached ADU shall be four hundred fifty (450) square feet. The unit shall include permanent provisions for living, sleeping, eating, cooking, and sanitation.</p> <p>9. The maximum square footage of the ADU shall be no greater than one thousand two hundred (1,200) square feet, except when the primary dwelling unit is one thousand two hundred fifty (1,200) square feet or smaller. In that case, the ADU may exceed one thousand two hundred fifty (1,200) square feet subject to the development standards for the zoning district.</p> <p>10. ADUs shall follow the development standards of the zone in which a lot is located, including but not limited to height, lot coverage, and setbacks.</p> <p>11. Setbacks are not required for an existing garage that is converted to an ADU and a setback of no more than five feet from the side and rear lot lines are not required for an ADU that is constructed above a garage.</p> <p>12. ADUs shall be located at the rear or the side of the existing single family dwelling unless it is demonstrated to the satisfaction of the Community Development Director that the ADU can only be located in front of the single family dwelling due to extraordinary or physical constraints of the lot.</p> <p>13. The entrance to an attached ADU shall be separate from the entrance to the primary dwelling unit and shall be located/designed in a manner as to eliminate an obvious indication of two units in the same structure.</p> <p>14. Plans that demonstrate an unobstructed pathway extending from a street to one entrance of the ADU are desirable prior to approval of an ADU application; however, is not a mandatory requirement for an ADU.</p> <p>15. The unit shall have adequate water supply and sewage disposal capability.</p> <p>16. ADUs, when converted from existing accessory structures, are permitted without additional restrictions provided the structure has independent exterior access and side and rear setbacks sufficient for fire safety.</p> <p>17. ADUs shall be subject to all development fees specified by city ordinances or resolutions for ADUs.</p> <p>18. Parking Requirements, consistent with Chapter 9.11 of this title:</p> <p>a. One parking space is required per</p> |
|--|--|

| | |
|--|---|
| | <p>bedroom of an Accessory Dwelling Unit and may be provided through tandem parking.</p> <ul style="list-style-type: none"> b. Parking is allowed in rear and side setback areas. No parking is allowed in front setback areas. c. When a garage or covered parking structure is demolished in conjunction with the construction of an Accessory Dwelling Unit, the replacement parking spaces may be located in any configuration on the same lot as the Accessory Dwelling Unit, including but not limited to covered spaces, uncovered spaces, or tandem spaces. However, replacement parking will not be a mandatory requirement. <p>19. Parking Exemptions. Additional parking spaces are not required for Accessory Dwelling Units in any of the following instances:</p> <ul style="list-style-type: none"> a. The ADU is located within one-half mile of a public transportation stop along a prescribed route according to a fixed schedule; or b. The ADU is located within one block of a car share parking spot; or c. The ADU is located in a historic district listed in or formally determined eligible for listing in the National Register of Historic Places and the California Register of Historical Resources or as a City Historic Preservation Overlay Zone; or d. When on-street parking permits are required but not offered to the occupant of the Accessory Dwelling Unit; or e. The Accessory Dwelling Unit is part of the existing Dwelling Unit or an existing accessory structure. <p>20. New detached or attached ADUs shall be compatible with the architectural style of the primary residence in design features. To determine architectural compatibility, the ADU must possess at least three of the following design elements in common with the primary building on the site:</p> <ul style="list-style-type: none"> a. Wall covering materials (wood, stucco, metal); |
|--|---|

| | |
|--|--|
| | <ul style="list-style-type: none">b. Wall texture (smooth, stucco, lace stucco, lap siding);c. Roofing material (tile, shake, composition, metal);d. Roof pitch;e. Structural eaves;f. Mass and scale of structure relative to structural height;g. Window characteristics (few or numerous, single pane, multi-pane, decorative); andh. Decorative treatments (pop-outs, columns, dormers, window surrounds, decorative arches) <p>21. Outside stairways serving ADUs should not be located on any building elevation facing a public street; and when unavoidable, the design of the stairway shall mute/mitigate any potential negative aesthetic impact and maintain the character of the existing single family residence.</p> <p>22. The property owner(s) shall enter into a written agreement with the city, in which the owner(s) agree to use the premises in compliance with the requirements of this section, any applicable enactments of the city council, and in form acceptable to the city attorney and the community development director. The written agreement shall include that any lease executed on an ADU shall automatically become a month to month tenancy at the time of sale or transfer of the property. Recordation of such agreement in the files of the county recorder shall be completed prior to issuance of a building permit for the ADU.</p> |
|--|--|

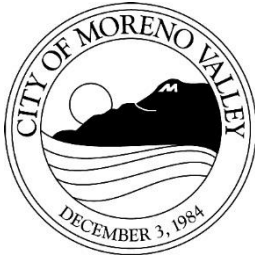

PLANNING COMMISSION

STAFF REPORT

Meeting Date: October 26, 2017

A CITYWIDE MUNICIPAL CODE (TITLE 9) AMENDMENT ADDRESSING LAND USE REGULATIONS FOR ACCESSORY DWELLING UNIT (ADU) (FORMERLY SECOND DWELLING UNITS) TO ENSURE COMPLIANCE WITH NEW STATE OF CALIFORNIA LAWS

Case: PEN17-0115

Applicant: City of Moreno Valley

Owner: City of Moreno Valley

Representative: Community Development Department

Location: Citywide

Case Planner: Claudia Manrique

Council District: All

SUMMARY

The proposed development code amendments will modify provisions in Title 9 of Moreno Valley Municipal Code (MVMC) related to Second Dwelling Units to bring it into compliance with new state regulations set forth in Senate Bill SB 1069 and Assembly Bill AB 2299 signed by Governor Jerry Brown in September 2016. A key change includes all references to second dwelling units being modified to Accessory Dwelling Units (ADU). The intent of the new State law for ADUs was to remove barriers to development of ADUs and to provide the public greater flexibility, opportunity and ease of access to housing supply options.

Background

California Government Code Section 65852.2 regarding second dwelling units was enacted in 1982 and it has been amended several times to encourage the creation of second dwelling units with sufficient flexibility to address unique local circumstances and conditions.

On April 13, 2010, the Moreno Valley City Council adopted Ordinance 817 to modify local development provisions required by then amended Government Code Sections 65583.1, 65852.2, and 65915 required by the passage of Assembly Bill 1866.

The current City Code provisions allow second dwelling units in all single-family residential zoning districts. Second dwelling units are allowed by right and permitting of such is considered a “ministerial” action.

New State Accessory Dwelling Unit Law

New state regulations set forth in Senate Bill SB 1069 and Assembly Bill AB 2299 approved in September 2016 became effective on January 1, 2017 and renamed second dwelling units to Accessory Dwelling Units (ADUs).

Assembly Bill AB 2299 provided that any existing local ordinance pertaining to ADUs that does not meet the Bill’s intent and written requirements is considered null and void as of January 1, 2017. In such cases, new applications for ADU’s must be processed based on Government Code Section 65852.2 regulations until such time that the local jurisdiction adopts a compliant ordinance.

PROJECT DESCRIPTION

To respond to State law changes, the following topics have been addressed:

- The subject heading for Section 9.09.130 will be revised to “Accessory Dwelling Unit (ADU)”;
- Added new definitions for ADU and efficiency units;
- Land use determination and permit processing procedures;
- Added development standards/provisions for efficiency units;
- Added restrictions pertaining to fire safety;
- Added utility connection fee restrictions;
- Clarified ADU setbacks and separation requirements;
- Added language covering parking exemptions; and
- Modifications made to Table 9.11.040A-12 (Off-Street Parking Requirements) in Chapter 9.11 (Parking, Pedestrian and Load Requirements).

The specific details for each change are further included in Attachment 2 to the staff report. In addition, to facilitate consideration of the proposed changes, Attachment 1 is provided for the Commissioners to review the existing zoning provisions for second dwelling units in the MVMC Section 9.09.130. Attachment 3 provides a “side-by-side” comparison table of the existing zoning and the proposed changes.

Three particularly noteworthy changes include:

1. Efficiency Units

The definition of efficiency units, as defined by Section 17958.1 of the Health and Safety Code, has been added. Efficiency units are for occupancy by no more than two persons, have a minimum floor area of 150 square feet and may also have partial kitchen or bathroom facilities. Under State law, the City can not prohibit efficiency units; therefore, the new language of the proposed ordinance authorizes the Community Development Director to approve efficiency units administratively when it can be demonstrated by an applicant that all applicable development standards are met.

2. Parking

Presently, the MVMC requires one open parking space be provided per bedroom for an ADU. This provision will remain, however the new State law provides for parking exemptions that the City must follow. Therefore, new language is recommended to be added to the MVMC so that the ADU parking requirement would be waived under any of the following five scenarios if requested by the applicant:

- (1) The accessory dwelling unit is located within one-half mile of public transit.
- (2) The accessory dwelling unit is located within an architecturally and historically significant historic district.
- (3) The accessory dwelling unit is part of the existing primary residence or an existing accessory structure.
- (4) When on-street parking permits are required but not offered to the occupant of the accessory dwelling unit.
- (5) When there is a car share vehicle located within one block of the accessory dwelling unit.

As a matter of process, it is noted that should an applicant wish to have the City waive an ADU parking requirement it will be incumbent upon the applicant, within the permit submittal materials, to demonstrate to the satisfaction of the Community Development Director that one or more of the five criteria noted above do in fact apply before a parking waiver will be granted. If none of the prerequisite conditions for the waiver are present, the project will be required to provide one uncovered parking space per bedroom for the ADU.

To ensure consistency within the MVMC, Table 9.11.040A-12 (Off-Street Parking Requirements) within Chapter 9.11 will be revised as follows to include an appropriate reference to the new provisions contained in Section 9.09.130:

| Residential Uses | Requirement | Covered Parking | Notes |
|---|-------------|-----------------|---|
| Second units Accessory Dwelling Unit | 1/bedroom | | The second dwelling unit shall provide a minimum of one parking space per bedroom in addition to the parking required for the main dwelling without blocking any required parking (no tandem parking). The Accessory Dwelling Unit shall provide a minimum of one |

| | | | |
|--|--|--|---|
| | | | parking space per bedroom in addition to the parking required for the main dwelling, except as exempted by State law (refer to 9.09.130 Accessory dwelling units). Spaces may be provided as uncovered and/or tandem parking on a driveway. |
|--|--|--|---|

3. Minimum and Maximum Unit Size

The MVMC currently establishes the minimum square footage for an ADU at four hundred fifty (450) square feet and a maximum size of one-thousand two-hundred fifty (1,250) square feet. The maximum square footage may be exempted in cases where the size of the existing primary dwelling unit is one-thousand two-hundred fifty (1,250) square feet or smaller. In those cases, the ADU may exceed one-thousand two-hundred fifty (1,250) square feet and the unit would be subject to the development standards for the zoning district. In order to achieve consistency with changes in the new State law these standards must be revised.

The proposed amendment will add a new provision that allows a minimum unit size for attached ADUs of one hundred and fifty (150) square feet consistent with the State law for efficiency units. The minimum size of four hundred fifty (450) square feet will remain for detached ADUs.

The new State law specifies the maximum size of an ADU to be one-thousand two-hundred (1,200) square feet, and for ADUs attached to an existing single family dwelling the ADU cannot be larger than 50% of the existing living areas. To ensure consistency with the new State law, the maximum square footage for detached ADUs within the MVMC will be reduced from one-thousand two-hundred fifty (1,250) to one-thousand two-hundred (1,200) square feet. The maximum square footage for attached ADUs will be limited to 50% of the existing living areas of the existing residence and in no event shall be greater than one-thousand two-hundred (1,200) square feet.

Additions to Section 9.15 (Definitions)

The proposed MVMC Section 9.09.130 Accessory Dwelling Units (ADU) includes the following new definitions, which will also be added to Section 9.15 (Definitions) of the MVMC as well:

- “Accessory dwelling unit” means an attached or a detached residential dwelling unit, which provides complete independent living facilities for one or more persons. It shall include permanent provisions for living, sleeping, eating, cooking, and sanitation on the same parcel that the existing single-family dwelling is situated.
- “Efficiency unit” means an attached unit for occupancy by no more than two persons which have a minimum floor area of 150 square feet and which may also have partial kitchen or bathroom facilities, as allowed in Section 17958.1 of the Health and Safety Code.

ENVIRONMENTAL

This proposed MVMC amendment qualifies for a statutory exemption per Section 15282(h) of the California Environmental Quality Act (CEQA) Guidelines, which specifically states that the adoption of an ordinance regarding second units in a single-family or multiple-family residential zone by a city or county to implement the provisions of Sections 65852.1 and 65852.2 of the Government Code relating to second unit ordinances are exempt from the requirements of CEQA.

NOTIFICATION

As prescribed by the City's Municipal Code, a modification to the zoning provisions of the MVMC requires a public hearing before the Planning Commission. In accordance with Section 9.02.200 of the Municipal Code, a 1/8 page public notice was published in the Press Enterprise newspaper on October 15, 2017 for the October 26, 2017 public hearing of the Planning Commission.

STAFF RECOMMENDATION

Staff recommends that the Planning Commission **APPROVE** Resolution No. 2017-33, and thereby:

1. **FIND** that PEN17-0115 (Municipal Code Amendment for Accessory Dwelling Units) qualifies for a Statutory Exemption in accordance with CEQA Guidelines, Section 15282(h); and
2. **RECOMMEND** that the City Council approve the proposed amendments to Title 9 of the City Municipal Code, PEN17-0115.

Prepared by:
Claudia Manrique
Associate Planner

Approved by:
Allen Brock
Community Development Director

ATTACHMENTS

1. Existing MVMC Section 9.09.130
2. Proposed MVMC Section 9.09.130
3. MVMC Section 9.09.130 Comparison Table
4. Public Notice
5. Resolution 2017-33

Claudia Manrique

From: Kathleen Dale <kdalenmn@aol.com>
Sent: Wednesday, October 25, 2017 5:29 PM
To: Claudia Manrique
Cc: prubin41@aol.com
Subject: 10/16/17 Planning Commission - Public Hearing Item 2, Accessory Dwelling Regulations
Attachments: SheffieldPlans4PC.pdf

Claudia - please see that these comments and the attachment are provided to the Commissioners.

Thank you,

Kathleen Dale

I only learned this item was on the 10/26 Planning Commission agenda on 10/24 and am not able to attend the hearing. I was part of a group of local residents that was involved in resolution of a controversial second unit proposal on Sheffield Drive last year. City staff were well aware that these residents were interested in this matter. The limited 1/8 page display ad in a newspaper that few people read is a sad effort to engage the public.

The following comments and suggested changes are provided for your consideration. With a few changes, the proposed ordinance could be a very workable option for implementing the State-mandated requirements in our community.

Clarifications

1. How is the 1/2-mile distance to public transportation measured in determining whether parking is required? It seems logical that this is intended to apply to the walking distance, rather than as the crow flies. The text in 9.09.130.F.19.A should be modified accordingly.
2. The proposed language in 9.09.130.C.1 and 9.09.130.F.8 seems to be inconsistent as to the requirements for fully-contained units with respect to kitchen and bathroom facilities. Section C could be interpreted as requiring that such facilities only need be on the same lot, whereas Section F reads as if they are to be within the unit. The Section F provision is preferable.

Questions

3. The proposed regulations retain the existing 7,200 square foot minimum lot size for detached accessory units (9.09.130.F.8). The Commission should understand how many lots within the City meet this requirement and how they are distributed throughout the City.
4. Ask staff about previously-approved second units and how many accessory unit applications are currently under consideration. Ask that they explain the circumstances for each - are they interior remodels, attached or detached. Ask how they address minimizing adverse consequences to the neighbors.

Changes

5. The Commission should consider increasing the minimum lot size for detached units (9.09.130.F.8). A change to somewhere between 8,000 and 10,000 square feet seems reasonable. It would be helpful to have information about the number and distribution of such parcels.
6. The proposed regulations allow parking to be placed in the side setback (9.09.130.F.18). This seems like a potential safety hazard and also presents concerns about compatibility with neighboring homes.
7. The proposed regulations note the potential for aesthetic impacts with exterior stair cases (9.09.130.F.21). There are also issues related to aesthetics and compatibility with placement of doors, windows, lighting and mechanical equipment. Expansion of this section of the ordinance to address all of these elements should help avoid the design issues that were central to the Sheffield Drive situation (plans for this abandoned project are attached for your information).
8. The Sheffield Drive situation provides a good example of potential issues with two-story detached units. Two-story additions may present similar issues. The Commission should consider incorporating provisions to limit two-story buildings/additions and/or to establish a notice and public review requirement in these circumstances (Section 9.09.130.E.3 of the proposed ordinance refers to variances as a circumstance that could take the authorization out of an administrative process).
9. The Commission should consider incorporating provisions for special considerations when any addition or detached unit extends habitable space closer to an existing neighbor.

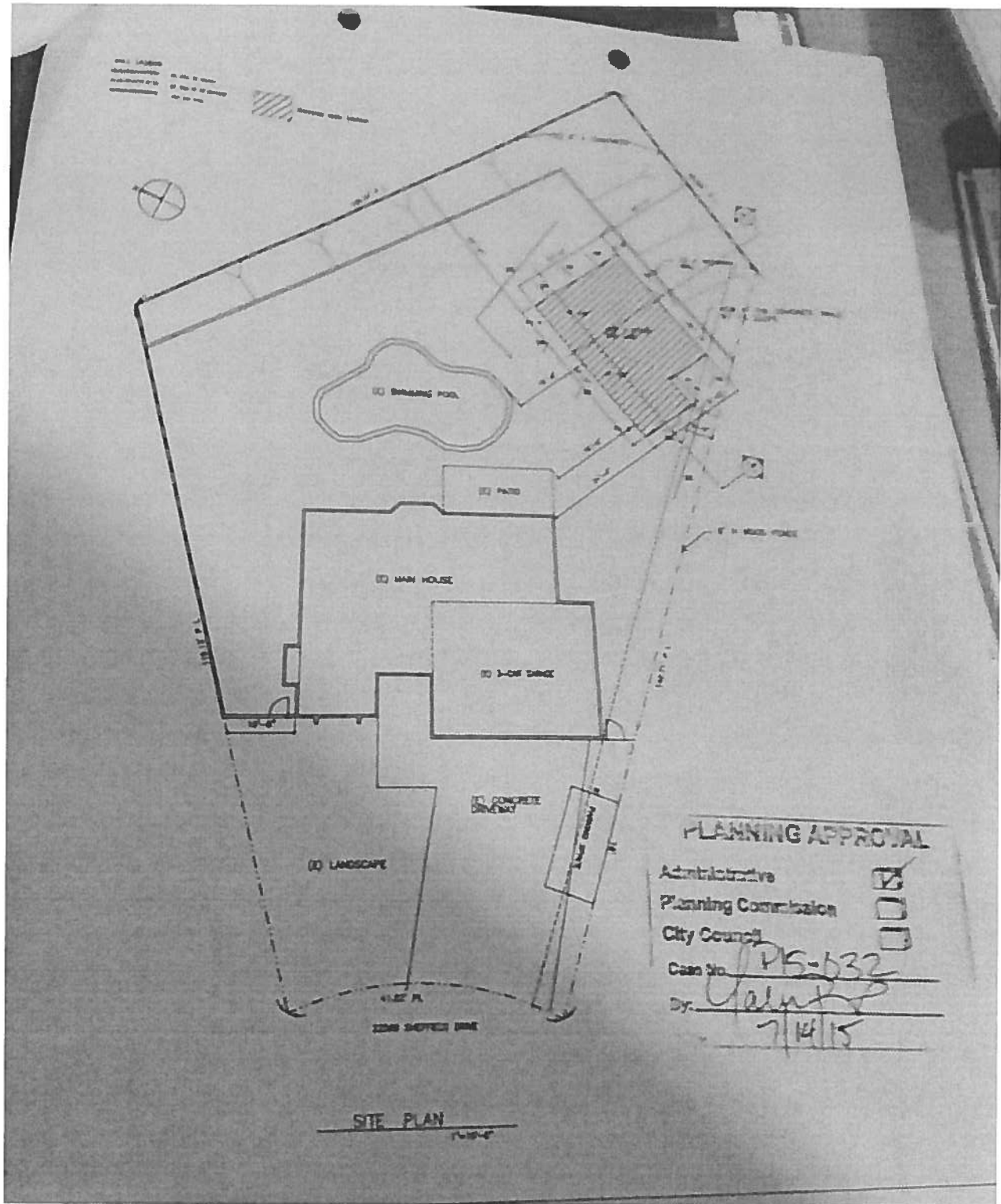

City-approved site plan

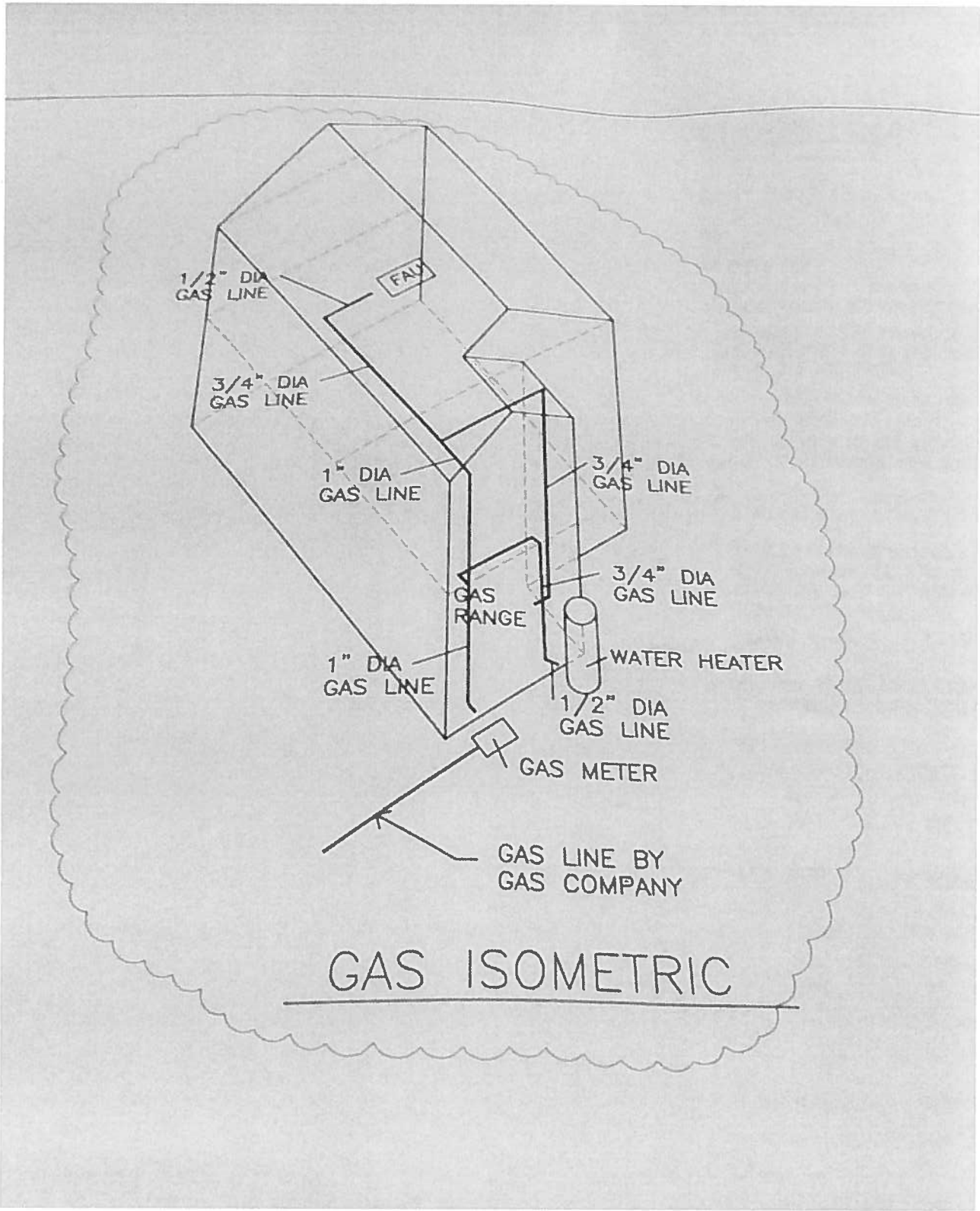

This diagram depicts the building mass of the proposed 1,200-square-foot, two-story second unit

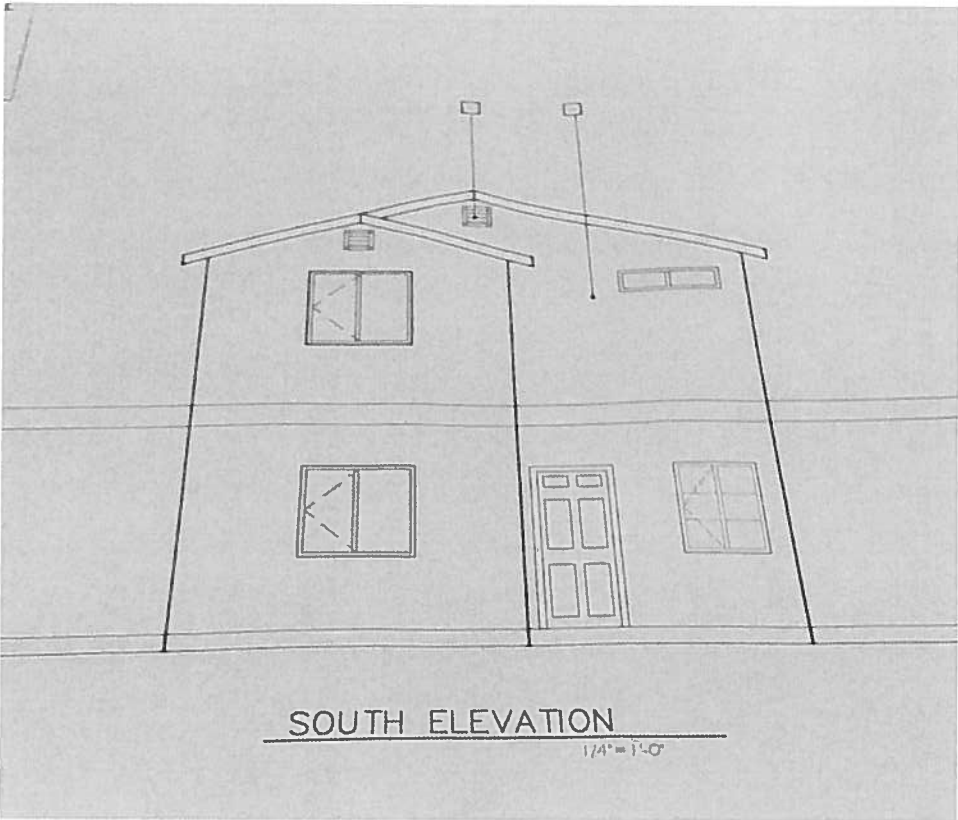

Elevation for wall of proposed two-story second unit facing common fence line (five feet away)

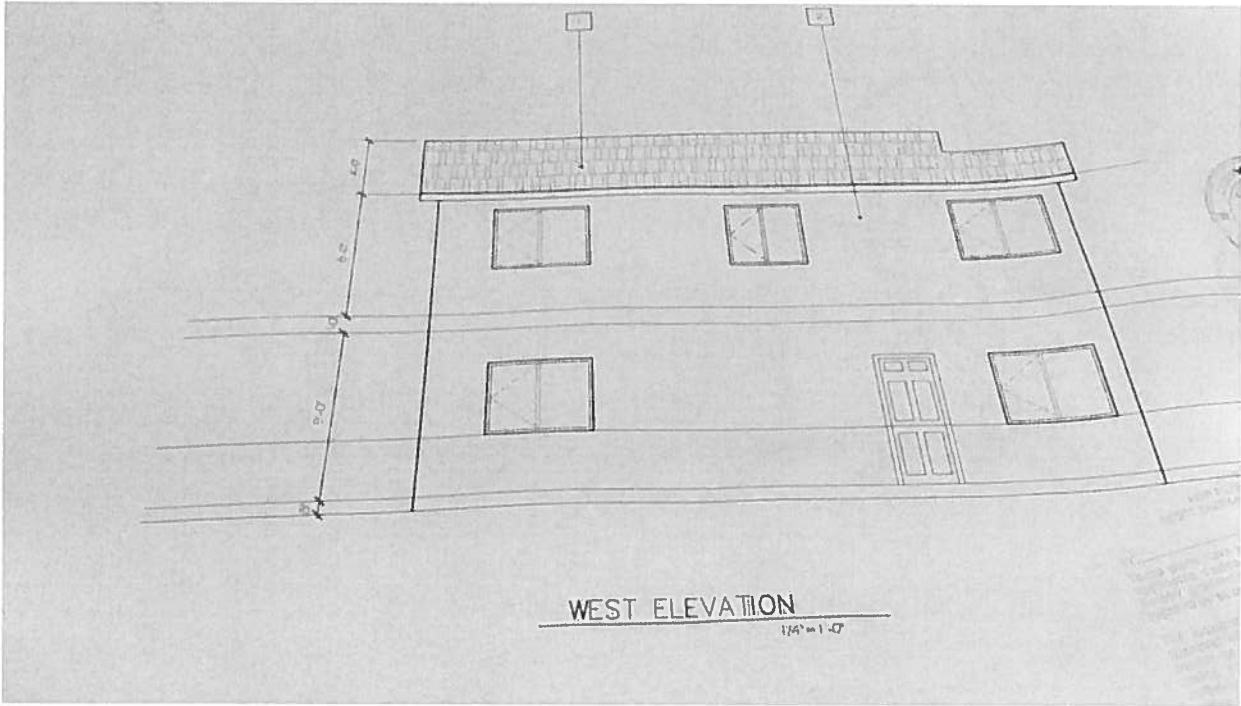

Elevation for wall of proposed two-story second unit facing street, windows and doors placed close to common property line



Aerial photo depicting approximate positioning of proposed second unit

1 **CITY OF MORENO VALLEY PLANNING COMMISSION**
 2 **REGULAR MEETING**
 3 **CITY HALL COUNCIL CHAMBER – 14177 FREDERICK STREET**
 4

5 **Thursday, October 26, 2017 at 7:00 PM**

6
 7
 8 **CALL TO ORDER**
 9

10
 11 **CHAIR BARNES** – Good evening ladies and gentlemen. I would like to call to
 12 order this regular-scheduled meeting of the Planning Commission to order. It is
 13 Thursday, October 26, 2017, and the time is 7:12 PM. Ashley, could we have roll
 14 call please?
 15

16
 17 **ROLL CALL**
 18

19 Commissioners Present:

20 Commissioner Lowell
 21 Commissioner Baker
 22 Commissioner Sims
 23 Vice Chair Korzec
 24 Chair Barnes
 25
 26

27 Staff Present:

28 Rick Sandzimier, Planning Official
 29 Ashley Aparicio, Recording Secretary/Administrative Assistant
 30 Jeff Bradshaw, Associate Planner
 31 Michael Lloyd, Traffic Engineer
 32 Paul Early, Assistant City Attorney
 33 Claudia Manrique, Associate Planner
 34
 35

36 Speakers:

37 Rafael Brugueras
 38
 39

40 **PLEDGE OF ALLEGIANCE**
 41
 42

43 **CHAIR BARNES** – The next item on the Agenda is the Pledge of Allegiance.
 44 Could you all stand and face the flag?

1
2
3 **APPROVAL OF THE AGENDA**
4

5 Approval of PC Agenda of October 26, 2017
6

7 **CHAIR BARNES** – Thank you. Next item is the approval of the Agenda for
8 October 26, 2017. That’s probably not right.
9

10 **COMMISSIONER SIMS** – I’ll make a motion to approve the Agenda.
11

12 **COMMISSIONER BAKER** – And I’ll second.
13

14 **CHAIR BARNES** – Yeah, what date are we approving?
15

16 **COMMISSIONER SIMS** – Well approval of today’s Agenda.
17

18 **COMMISSIONER BAKER** – Not the Minutes.
19

20 **CHAIR BARNES** – Oh, the Agenda, duh.
21

22 **COMMISSIONER SIMS** – You’re doing it.
23

24 **CHAIR BARNES** – Once again, the Chair has fallen down.
25

26 **COMMISSIONER BAKER** – It’s okay. Move on.
27

28 **CHAIR BARNES** – My apologies. We had a motion from Commissioner Sims.
29

30 **COMMISSIONER LOWELL** – I’ll second.
31

32 **CHAIR BARNES** – Two seconds, Commissioners Baker and Lowell.
33

34 **COMMISSIONER LOWELL** – Come on, Patricia. Get in on it.
35

36 **VICE CHAIR KORZEC** – I’ll third it, alright, fine.
37

38 **PLANNING OFFICIAL RICK SANDZIMIER** – We’re going to try this system that
39 we explained to you at the beginning, so the motion and the second.
40

41 **CHAIR BARNES** – Alright.
42

43 **ADMINISTRATIVE ASSISTANT ASHLEY APARICIO** – The motion was...
44

45 **PLANNING OFFICIAL RICK SANDZIMIER** – From Commissioner Sims.
46

1 **CHAIR BARNES** – Commissioner Sims made a motion.

2
3 **PLANNING OFFICIAL RICK SANDZIMIER** – Seconded by Lowell.

4
5 **COMMISSIONER LOWELL** – So the Chair no longer runs the vote button?

6
7 **CHAIR BARNES** – No.

8
9 **PLANNING OFFICIAL RICK SANDZIMIER** – Yeah, we're adopting to the City
10 Clerk's....

11
12 **CHAIR BARNES** – There's a new sheriff in town, so please vote. So, all votes
13 have been cast. The...end the vote.

14
15 **COMMISSIONER LOWELL** – It's a learning curve.

16
17 **CHAIR BARNES** – The motion carries 5-0.

18
19
20 Opposed – 0

21
22
23 **Motion carries 5 – 0**

24
25
26 **PLANNING OFFICIAL RICK SANDZIMIER** – Mr. Chair, just, if I may.....

27
28 **CHAIR BARNES** – Yes.

29
30 **PLANNING OFFICIAL RICK SANDZIMIER** – Just for the record, since we are
31 live on TV and some people may be observing us, I do want to mention then, for
32 the rest of the people here and Commissioner Lowell has just arrived, we are
33 trying to adopt the same process that the City Clerk's Office is using with the
34 recording secretary, so if we go through a couple of little glitches this evening, I
35 just want to apologize up front. I also want to take a second just to introduce
36 Ashley Aparicio. She is our new recording secretary and administrative assistant
37 in our Planning Division. Thank you.

38
39 **CHAIR BARNES** – Well welcome, Ashley, and thank you very much for your
40 help this evening.

41
42 **ADMINISTRATIVE ASSISTANT ASHLEY APARICIO** – You're welcome.

43
44
45 **CONSENT CALENDAR**

1 All matters listed under Consent Calendar are considered to be routine and all
 2 will be enacted by one rollcall vote. There will be no discussion of these items
 3 unless Members of the Planning Commission request specific items be removed
 4 from the Consent Calendar for separate action.

5 6 7 APPROVAL OF MINUTES

8
9 Planning Commission - Regular Meeting – August 24, 2017 at 7:00 PM

10
11
12 **CHAIR BARNES** – The next item on the Agenda is the Consent Calendar. The
 13 only item being the approval of the Minutes from the meeting of August 24, 2017.

14
15 **COMMISSIONER BAKER** – I'll make a motion.

16
17 **VICE CHAIR KORZEC** – I'll second.

18
19 **CHAIR BARNES** – A motion from Commissioner Baker. A second from
 20 Commissioner Korzec.

21
22 **COMMISSIONER LOWELL** – I was not present at that meeting, so I will be
 23 abstaining.

24
25 **CHAIR BARNES** – And Commissioner Lowell will not be voting because he was
 26 not in attendance, so please vote. The motion carries 4-0 with one abstention.

27
28
29 Opposed – 0

30
31
32 **Motion carries 4 – 0 – 1 with one abstention**

33 34 35 PUBLIC COMMENTS PROCEDURE

36
37 Any person wishing to address the Commission on any matter, either under
 38 Public Comments section of the Agenda or scheduled items or public hearings,
 39 must fill out a "Request to Speak" form available at the door. The completed
 40 form must be submitted to the Secretary prior to the Agenda item being called by
 41 the Chairperson. In speaking to the Commission, member of the public may be
 42 limited to three minutes per person, except for the applicant for entitlement. The
 43 Commission may establish an overall time limit for comments on a particular
 44 Agenda item. Members of the public must direct their questions to the
 45 Chairperson of the Commission and not to other members of the Commission,
 46 the applicant, the Staff, or the audience. Upon request, this Agenda will be made

1 available in appropriate alternative formats to persons with disabilities in
 2 compliance with the Americans with Disabilities Act of 1990. Any person with a
 3 disability who requires a modification or accommodation in order to participate in
 4 a meeting should direct their request to Guy Pegan, ADA Coordinator, at (951)
 5 413-3120 at least 72 hours prior to the meeting. The 72-hour notification will
 6 enable the City to make reasonable arrangements to ensure accessibility to this
 7 meeting.

8
 9
 10 **CHAIR BARNES** – Moving on. The next item on the Agenda is the Public
 11 Comments portion of the meeting.

12
 13 **ADMINISTRATIVE ASSISTANT ASHLEY APARICIO** – We do have one.

14
 15 **CHAIR BARNES** – We have one speaker. If you could call him forward please.

16
 17 **ADMINISTRATIVE ASSISTANT ASHLEY APARICIO** – Rafael Brugueras. I
 18 apologize.

19
 20 **CHAIR BARNES** – Brugueras. You'll learn to pronounce it because he will.....

21
 22 **ADMINISTRATIVE ASSISTANT ASHLEY APARICIO** – Thank you.

23
 24 **CHAIR BARNES** – Speak on occasion.

25
 26 **SPEAKER RAFAEL BRUGUERAS** – Welcome aboard, Ashley.

27
 28 **ADMINISTRATIVE ASSISTANT ASHLEY APARICIO** – Thank you.

29
 30 **SPEAKER RAFAEL BRUGUERAS** – Chair, Commissioners, Staff, and guests,
 31 I'm the only resident here tonight. I'm grateful to be back in the chamber again
 32 from Tuesday because that was an exciting meeting. One out of the two got
 33 passed and that is going to be pertaining to this Planning Commission. It is a
 34 shame that we couldn't get the ban extended because that would've helped the
 35 staff to have a little more time to make sure everything that they are going to be
 36 doing with Allen Brock, Rick Sandzimier, to make sure that when you get a
 37 project to be built in this city or an entrepreneur to bring a business to sell
 38 marijuana you'll be prepared. So I'm hoping that, as the months we wait for this
 39 bill to come out and to get approved, that somehow you'll be ready and trained in
 40 this area to understand what some of these entrepreneurs and developers want
 41 from us because it could harm the city. It could also help the city. It was a good
 42 fight Tuesday. I learned a lot. I learned that pride can get in the way also. I'm
 43 hoping that it never happens to this government. This is one of the governments
 44 that I fought for when I was talking on Tuesday. This is a very important
 45 government. Each one of you plays a great role in our city in all parts, not just
 46 one district but all four districts. That includes the whole city, all 210,000 of us.

1 You're very important to us and the Staff here is very important to us. So
2 prepare your hearts and your minds as things come forward. I don't know if it's
3 going to be in the next month or in the New Year, but we as a city must be ready
4 with the new laws, the new rules, and how to distribute and allow the sales of
5 marijuana to flow through our city. Let's think about what we want to do in the
6 future. Thank you so much, and I am thankful that Brian made it. I'm glad when
7 I see five of you up here. It's a good thing. Thank you.

8
9 **CHAIR BARNES** – Thank you, Mr. Brugueras. No other speakers?

10
11 **ADMINISTRATIVE ASSISTANT ASHLEY APARICIO** – No other speakers, Sir.

12
13 **CHAIR BARNES** – Thank you. Next on the Agenda, Non-Public Hearing Items.
14 We have none, right Rick?

15
16 **PLANNING OFFICIAL RICK SANDZIMIER** – We have none.

17
18
19 **NON-PUBLIC HEARING ITEMS**

20
21 None

22
23
24 **CHAIR BARNES** – And Public Hearing Items: Case 1, PEN16-0050, an
25 application from MACJONES Holdings, Inc. Do we have a Staff Report?

26
27
28 **PUBLIC HEARING ITEMS**

- 29
- 30
- 31 1. Case: PEN16-0050 (PA16-0009)
- 32
- 33 Applicant: MACJONES Holdings, Inc.
- 34
- 35 Owner: MACJONES Holdings, Inc.
- 36
- 37 Representative: Thienes Engineering, Inc.
- 38
- 39 Location: South side of Cottonwood Avenue at Lakeport
- 40 Drive
- 41
- 42 Case Planner: Jeff Bradshaw
- 43
- 44 Council District: 3
- 45

1 Proposal: Proposed Tentative Tract Map to subdivide 10
 2 acres of vacant RA-2 zoned land into 16
 3 single-family residential lots, and three lettered
 4 lots for water quality treatment facilities.
 5
 6
 7
 8

9 **STAFF RECOMMENDATION**

10
 11 A. Staff recommends that the Planning Commission **APPROVE** Resolution No.
 12 2017-34 and thereby:

13
 14 1. **CERTIFY** that the Mitigated Negative Declaration prepared for Tentative
 15 Tract Map 37060 (PEN16-0050) on file with the Community Development
 16 Department, incorporated herein by this reference, has been completed in
 17 compliance with the California Environmental Quality Act, that the
 18 Planning Commission reviewed and considered the information contained
 19 in the Mitigated Negative Declaration and the document reflects the City's
 20 independent judgment and analysis, attached hereto as Exhibit A and;

21
 22 2. **ADOPT** the Mitigation Monitoring and Reporting Program prepared for
 23 Tentative Tract Map 37060 (PEN16-0050), attached hereto as Exhibit B.
 24

25 B. Staff recommends that the Planning Commission **APPROVE** Resolution No.
 26 2017-35 and thereby:

27
 28 1. **APPROVE** Tentative Tract Map 37060 (PEN16-0050) based on the
 29 findings contained in this Resolution, and subject to the Conditions of
 30 Approval included as Exhibit A.
 31
 32
 33
 34

35 **PLANNING OFFICIAL RICK SANDZIMIER** – We do. Associate Planner, Jeff
 36 Bradshaw will be giving your this presentation.
 37

38 **ASSOCIATE PLANNER JEFF BRADSHAW** – Good evening, Chair Barnes, and
 39 Members of the Planning Commission. As you introduced, Chair Barnes, the
 40 Applicant, MACJONES, has submitted a subdivision application to the City for
 41 approval of Tentative Tract Map 37060. This subdivision proposes to develop 16
 42 lots on a 10-acre site that is located on the south side of Cottonwood Avenue and
 43 approximately 700 feet east of LaSalle. The site is currently vacant. It has been
 44 maintained in recent history through weed abatement and is surrounded by
 45 comparable types of development. The land to the west has been developed
 46 with similar half-acre lots in the RA-2 Zone. The project site is zoned RA-2. The

1 land to the east, in a similar fashion, has either been subdivided or developed
 2 with half-acre home sites and the properties to the north and south, as you can
 3 see in the exhibit, have been developed with tract homes in the R5 Zone. The
 4 Applicant is asking the City to support a subdivision here that is consistent with
 5 the RA-2 Zone. The 16 lots that are being proposed are all at least 20,000
 6 square feet in size, which is consistent with that zone. Again, surrounding
 7 properties have been developed or subdivided with comparable lots and so the
 8 proposal is consistent with the General Plan, the zoning for the site, and with
 9 existing or established development for that area. Staff worked in the
 10 preparation of a Mitigated Negative Declaration for the project and through the
 11 completion of an initial study we determined that, with mitigation, this project
 12 would not result in any significant environmental impacts. A Mitigated Monitoring
 13 Program was also prepared for the project to ensure implementation of those
 14 Mitigation Measures. The project.....excuse me.....notice for the project was
 15 completed by our City Standard with a publication in the newspaper, notifying the
 16 preparation of the Mitigated Negative Declaration. The site was posted 10 days
 17 in advance of the hearing, and notices were sent out to property owners within
 18 300 feet of the site as well. As of tonight, I have received only one phone call in
 19 response to those noticing efforts. It was a property owner that lives in a home
 20 immediately to the west. His property would back to this development. He
 21 stated he was in support of the project and just had questions about the
 22 availability of sewer service to that area. With that, Staff would...Staff's
 23 recommendation to the Planning Commission would be to certify the
 24 environmental documentation that has been prepared for the project and to
 25 approve the Tract Map as conditioned and as presented to you this evening.
 26 That concludes my report. I'd be happy to answer any questions that you might
 27 have.

28
 29 **CHAIR BARNES** – Thank you, Jeff. Would the Commissioners like to ask any
 30 questions? Would the Applicant like to make a statement?

31
 32 **COMMISSIONER SIMS** – Sorry. I do have my, the red light on. So lots C and D
 33 are the water quality lots that are small detention basins, I assume?

34
 35 **ASSOCIATE PLANNER JEFF BRADSHAW** – Yes, in this case, a little bit
 36 unique proposal for the water quality treatment. Rather than a single basin, there
 37 are three water quality treatment facilities proposed. There is a linear treatment
 38 facility on lot 1 along the street frontage, and then lots 12 and 13 both have water
 39 treatment facilities in lettered lots on both those sites.

40
 41 **COMMISSIONER SIMS** – And those lettered lots, they are maintained by the
 42 City or is that an HOA or how is that taken care of?

43
 44 **ASSOCIATE PLANNER JEFF BRADSHAW** – They would be maintained by the
 45 City but with an HOA required of the project, like with other subdivisions as a

1 backup or support to that process with the City being compensated through that
2 HOA.

3
4 **COMMISSIONER SIMS** – Thank you.

5
6 **CHAIR BARNES** – Any other questions? Would the Applicant like to make a
7 presentation or a statement?

8
9 **APPLICANT DAN WEBB** – Hello, my name is Dan Webb from MACJONES. I
10 just want to thank everybody for coming, and I want to thank the Planning
11 Department for working well with my team, and I really have nothing else to add.
12 I think it's a really nice project for the area, and it fits in well with the zoning and
13 fits in well with the neighbors, and I think it should go well.

14
15 **CHAIR BARNES** – Thank you.

16
17 **COMMISSIONER LOWELL** – I have a question for you. The last Tentative Map
18 expired. What is your timeframe for this project? Do you envision sitting on it for
19 a few years or are you ready to dig a shovel of dirt tomorrow?

20
21 **APPLICANT DAN WEBB** – It depends on the market. It's really close right now
22 in terms of, you know, since you're requiring me to have such large acreage, it
23 puts it up into a pretty....it's, you know, I was lucky to buy the land at a pretty
24 attractive price and that benefit can be passed through to the City of Moreno
25 Valley because I could afford to keep these big lots where a lot of other people
26 can't. The market is like right there, and so my goal is to do it in the next year or
27 two, but I am just really identifying the comps right now and seeing if I can make
28 some money on it.

29
30 **COMMISSIONER LOWELL** – Thank you.

31
32 **CHAIR BARNES** – Any other questions. If not, while you think about it, I have a
33 couple of questions. On one of the previous meetings we had discussed, I
34 thought, adding the number of extensions to the condition that addresses the
35 expiration date of the map.

36
37 **PLANNING OFFICIAL RICK SANDZIMIER** – Mr. Chair, are you....I apologize
38 for maybe interrupting, but are you going to be talking about the project and
39 deliberating the project or would you like to conduct the Public Hearing first
40 because it does require a Public Hearing.

41
42 **CHAIR BARNES** – Yeah, thank you. Don't we normally ask questions of the
43 Staff?

44
45 **PLANNING OFFICIAL RICK SANDZIMIER** – That's why I was trying to get
46 clarification there. If you were going to be asking Staff questions or if you're

1 getting into deliberations about the Conditions of Approval and the project as a
2 whole but, if it is still questions for Staff, that's appropriate, I guess.

3
4 **CHAIR BARNES** – Well, they are questions regarding the conditions, but I
5 wouldn't call them deliberation. It's just clarifications.

6
7 **PLANNING OFFICIAL RICK SANDZIMIER** – Okay.

8
9 **CHAIR BARNES** – Is that appropriate?

10
11 **PLANNING OFFICIAL RICK SANDZIMIER** – That's fine.

12
13 **CHAIR BARNES** – Okay, alright. Well, how many extensions would a project
14 like this be entitled to?

15
16 **ASSOCIATE PLANNER JEFF BRADSHAW** – The total map life under the Map
17 Act would be eight years, and so there would be an opportunity under separate
18 applications to extend the life for a total of five and, by our Code, it would be
19 three years at a time. So the next extension would be three and then two.

20
21 **CHAIR BARNES** – Okay, so two more extensions, one 3-year and one 2-year.
22 Okay.

23
24 **ASSOCIATE PLANNER JEFF BRADSHAW** – Yes.

25
26 **CHAIR BARNES** – Okay, alright. And then Condition P9 talks about the
27 developer shall submit to review a document to convey title. Is that for the
28 WQMP basins? I was a little unclear as to what they were conveying title to.

29
30 **ASSOCIATE PLANNER JEFF BRADSHAW** – That, I believe, is something we
31 want to correct in the conditions. In this case, the other intent of the HOA would
32 be to retain fee ownership of the basins, not to turn those over to the City, so (A)
33 I do not see as being applicable in this case.

34
35 **CHAIR BARNES** – Okay, alright. Thank you. Condition P11 makes reference to
36 a Slope Erosion Plan. What...I'm not familiar with that plan. Is that something
37 that Land Development now requires or?

38
39 **ASSOCIATE PLANNER JEFF BRADSHAW** – I apologize, Chair Barnes. I was
40 making notes in my conditions. Do you mind repeating the question?

41
42 **CHAIR BARNES** – Yeah, Condition P11, prior to Grading Permit issuance, that
43 condition makes a reference to a Slope Erosion Plan.
44

1 **ASSOCIATE PLANNER JEFF BRADSHAW** – Yes, so Planning would require
 2 landscape and erosion, irrigation rather, for slopes that are over this three feet in
 3 height. It'd be private slopes in the rear yards.

4
 5 **CHAIR BARNES** – Okay.

6
 7 **ASSOCIATE PLANNER JEFF BRADSHAW** – I can't recall in this tract if that
 8 applies. I know there are some transition slopes, but that is the intent of the
 9 condition is to capture private slopes.

10
 11 **CHAIR BARNES** – Okay, I just....that term was not clear to me, so alright.
 12 Thank you. Then, Condition P18 requires that knuckles and cul-de-sac lots
 13 provide off street parking for at least three cars. Is that unique to this project or is
 14 that a condition that will be.....

15
 16 **ASSOCIATE PLANNER JEFF BRADSHAW** – That is a condition that is an
 17 extension of a concern of the Planning Commission from some years ago. I
 18 don't know if anyone is seated on the Commission now that spoke to that but
 19 during the mid 2000's when development was moving very quickly, there was a
 20 concern that the subdivisions, as they were being proposed, were not provided
 21 adequate parking within the neighborhood and this was an effort to make sure
 22 each homeowner would have sufficient space to park their vehicles.

23
 24 **CHAIR BARNES** – Okay, well I don't want to wander into the area of
 25 deliberation, but I might want to discuss that further at some point. So will that
 26 condition become standard in the future?

27
 28 **PLANNING OFFICIAL RICK SANDZIMIER** – As Mr. Bradshaw articulated, it
 29 was an interest or a concern of a previous Planning Commission that is not, as I
 30 understand it, codified in our Municipal Code for a parking requirement. When
 31 you consider the design of a cul-de-sac or knuckles the consideration or the
 32 concern is that it has less street frontage because of the curve of the street and
 33 since cars that normally on a typical just, you know, subdivision lot has curb
 34 frontage in front of their homes. The ones at the ends of cul-de-sacs and
 35 knuckles don't. So, if you allow for more parking on the site, then you're
 36 addressing the issue.

37
 38 **CHAIR BARNES** – Well, the reason I was curious about it is we've approved
 39 some projects in the past that have been fairly small lots, extremely small lots,
 40 and even rectangular lots facing a straight street have had very little lot frontage
 41 and parking has been a concern but.....

42
 43 **PLANNING OFFICIAL RICK SANDZIMIER** – The only other thing that I would
 44 point out with this particular subdivision is it is a large lot subdivision, so these
 45 are half-acre lots. We don't have the actual Site Plans where the homes are
 46 going to placed but, usually on a half-acre lot or so, you're actually going to have

1 larger driveways or side yards and other opportunities. It may not be necessary
 2 to actually put a condition in place like this. It would probably be belts and
 3 suspenders because the actual design of the half-acre lot, you're probably going
 4 to end up with more parking.

5
 6 **CHAIR BARNES** – Yeah, you're going to have much larger front setbacks and
 7 longer driveways, so I was just curious the source of that condition. I think the
 8 last question I.....oh, second to last question. Condition B5, from Building and
 9 Safety, proposed residential project shall comply with the latest Federal Law,
 10 etc., etc., etc. There is no grandfathering that goes along with these conditions?
 11 If any of the statutes listed in there were to change, they would be required in the
 12 case of all of those to comply with the current?

13
 14 **PLANNING OFFICIAL RICK SANDZIMIER** – It is my understanding that the
 15 building and fire codes and specific to public health, safety, and welfare-type
 16 issues so those codes, when they do change, the developments are subject to
 17 the ones that are in existence at the time of the development.

18
 19 **ASSOCIATE PLANNER JEFF BRADSHAW** – The issuance of a building permit
 20 would be the only thing that would really excuse a project from being held to a
 21 higher standard or a new requirement.

22
 23 **CHAIR BARNES** – Right, I guess my question was, and it doesn't relate just to
 24 public safety.....go ahead....

25
 26 **PLANNING OFFICIAL RICK SANDZIMIER** – I was just asking for.....

27
 28 **CHAIR BARNES** – What, what came to mind was Americans with Disabilities Act
 29 so, if next year the regulations changed and two-story houses now require an
 30 elevator, would this project then be required to put in an elevator or would he be
 31 grandfathered to the current ADA Standard?

32
 33 **COMMISSIONER LOWELL** – What I think happens is, when you start pulling
 34 your permits, that's what codifies what criteria you're held to. So, if you're going
 35 to pull a building permit today, you're held to today's standards. But, if you're
 36 pulling a grading permit or a building permit in 10 years, you'll be held to the
 37 standard that is in place in 10 years. So this is like a benchmark saying, "Hey, by
 38 the way, whenever you pull the permit, that's the standard you have to go to." It's
 39 just a statement.

40
 41 **ASSOCIATE PLANNER JEFF BRADSHAW** – The balance in the process is,
 42 you asked about extensions of time, so in three years' time if the project has not
 43 been developed and they come to the City and ask for that extension, that'd be
 44 an opportunity for Staff to revisit the conditions; not to place new conditions but, if
 45 standards or requirements have changed, we would update the conditions to
 46 update the most current standard in place at the time.

1
2 **CHAIR BARNES** – Okay, just kind of caught me by surprise a little bit. Alright,
3 and then the last question I had, concerns the grading on lot 16. I was curious
4 why that hillslope is contained entirely on 16 and not adjusted so that the top is
5 on the property line, which is the more traditional configuration because, in this
6 scenario, the fence will be at the bottom of the slope, and the owner of 16
7 standing in his backyard is going to look right down in 15 with really no slope
8 hindering his view. He might not care but the owner of 15 might.

9
10 **TRAFFIC ENGINEER MICHAEL LLOYD** – Good evening, Chair. Michael Lloyd
11 with Land Development. This was proposed by the Applicant. I see your
12 concern, so if you felt that was applicable and appropriate to put the wall at the
13 top of the slope, the Staff would support that, and we would recommend a
14 condition to reflect that.

15
16 **CHAIR BARNES** – We'll save that for the deliberation portion of our comments.
17 I have no other questions. Anyone else?

18
19 **COMMISSIONER SIMS** – I do.

20
21 **CHAIR BARNES** – Commissioner Sims.

22
23 **COMMISSIONER SIMS** – What does the...there will be....I guess my question is
24 there will be an HOA on this development, these 16 lots?

25
26 **ASSOCIATE PLANNER JEFF BRADSHAW** – There are no common areas,
27 other than the basins that would require an HOA but, but City requirement, the
28 HOA has to be established because of the water quality basis?

29
30 **COMMISSIONER SIMS** – And so what would be the limit and scope of what the
31 HOA would control within the 16 lots? Just the water quality basins
32 maintenance?

33
34 **ASSOCIATE PLANNER JEFF BRADSHAW** – That's correct.

35
36 **PLANNING OFFICIAL RICK SANDZIMIER** – For a little bit of clarification, in the
37 Staff Report, we actually....the HOA has not yet been established. It would
38 predominantly be for the water quality treatment basins, but one of the things we
39 might want to work with the Applicant on is the common-area walls, particularly
40 the perimeter walls and any other things that might be of interest to the Applicant
41 to explore. We did write into the Staff Report that it would be at the discretion of
42 the Applicant at this time, but it is not that we don't want to talk about it. If there
43 is some interest of the Commission, we would be interested to hear back from it.
44 I believe the common-area maintenance that is done, particularly for the exterior
45 walls, the perimeter walls. If they are done consistently, it has a better image for
46 the city. If we allow each of the individual homeowners on the walls and fences

1 to take care, there is a likelihood you could get some inconsistencies, which we
2 do see around town today, so in the long haul, I'm looking for ways to improve
3 that.

4
5 **COMMISSIONER SIMS** – And this is probably more a question of the developer,
6 rather than the Staff, but the R5 is directly to the south of this. I guess that would
7 be to the south of this. Why wouldn't an R5 be appropriate for development of
8 this property? I guess, in my opinion, if this is.....and I don't know if this is in the
9 overlay for the.....what did we call that with the animal keeping.....

10
11 **COMMISSIONER LOWELL** – The PAKO.

12
13 **COMMISSIONER SIMS** – The PAKO, yeah, that's it.

14
15 **ASSOCIATE PLANNER JEFF BRADSHAW** – It's outside of that area.

16
17 **COMMISSIONER SIMS** – It's outside of the PAKO, so in 2020, I don't know if
18 there is really animal keeping, so this is kind of a square peg in a round hole type
19 of thing. I just speak from experience living on a half-acre parcel of my
20 development that has been out there. Probably 90% of the homes do not have
21 yards. A half acre is a lot of property to try to maintain and, to me, when you
22 distinguish in my neighborhood where our houses are, in comparison to the
23 Richmond American Homes that went in several years after our development
24 went, they downsized. They went in through a Change of Zone and went to
25 third-acre lots, and they have an HOA that requires all the front yards to be
26 maintained, and it is a significantly better development; much, much better. The
27 house prices are higher. The feel, the look of the houses, and the streetscape is
28 much, much better. So, anyhow, long story short, I'm not opposed to a half acre,
29 but it just seems this is.....I don't know, just because it's R2 doesn't mean it's the
30 right thing for the city to have more R2 where it's hard to maintain and meet a
31 pricing point for a developer.

32
33 **PLANNING OFFICIAL RICK SANDZIMIER** – I'd be happy to share some insight
34 on that. It may fall under the discussion on the project, but just risking that we
35 might go that far, I was going to tell you real quickly this is something that we did
36 consider as a staff. There is a nuance here that the General Plan Land Use
37 designation for this site is R5. It's the zoning designation for the site, which is
38 RA2, which is causing it to be developed at the two acres, the two dwellings per
39 acre. If the Applicant wanted to propose an R5-type development, it would
40 require a Zone Change. That wasn't a request, so we've just reacted to the
41 Applicant's interest, and we've processed it because it is consistent with the
42 zoning, but there could be an option, it would just require another phase. You'd
43 have to go through the Zone Change. So if you want to talk about that in a little
44 more detail later, but I think we should probably open up the Public Hearing if
45 there is anybody that wants to speak on it or if the Applicant wants to come back
46 and maybe provide any input, so.

1
2 **CHAIR BARNES** – Fair enough. Let’s suspend our question-and-answer period
3 and open the Public Hearing. Do we have any members of the public wishing to
4 speak?

5
6 **ADMINISTRATIVE ASSISTANT ASHLEY APARICIO** – Yes, we do. We have
7 Rafael.....

8
9 **CHAIR BARNES** – Brugueras.

10
11 **ADMINISTRATIVE ASSISTANT ASHLEY APARICIO** – Brugueras.

12
13 **SPEAKER RAFAEL BRUGUERAS** – Thank you, again, Commissioners, Staff,
14 and our guests. I went by this two days ago because it is on Cottonwood, and
15 Cottonwood is a major street. It goes from east to west, and it is used constantly,
16 and the project is between Morrison and LaSalle, more towards LaSalle and,
17 finally, it is going to be occupied with homes. And I looked at the 20,000 half
18 acre, and I understand what Mr. Sims was talking about because I was talking to
19 the developer....or to the Applicant about that and one of the things that caught
20 my interest was the HOA because I know that Shadow Park Mountain, Hidden
21 Springs, Sunnymead Ranch, Moreno Valley Ranch, they have HOA’s, and they
22 are required to keep the front always, at least 80% of the front, with lawn; some
23 kind of décor, landscaping to make the property value stay up. And, it’s true,
24 when you have something too big, it gets harder and harder to maintain,
25 especially if you work outside of the city and you’ve got to drive all way and
26 you’ve only got the weekends, or you’ve gotten a little older and something
27 physical happened to you that you can no longer do it. Those are the things that
28 can happen in the future, and this is something that we talked about when we
29 had the village in Ironwood and how they wanted to keep it an acre or more, and
30 the developer wanted to have it at 7100 to about 17,000 square feet. That was
31 easy to maintain, less than 20,000. Okay? So I like the idea that it’s going to
32 have the drainage for the water. That caught my interest too but, what really
33 caught my interest was the HOA, holding the property owners responsible for
34 their front yards at least because it would have helped the neighborhood to grow.
35 You know, a half acre is beautiful because you can put your RV and all your toys
36 in the back. It’s a wonderful thing to have that space, but it is good to have
37 that.....also it is good to be responsible to that space and do let it, like we just
38 heard, all the front yards, it rains and mud runs off into the curb, into the street,
39 into the sewage. That’s what happens when you don’t have front yards and no
40 HOA. People do as they like or, what happened a few years ago, Jerry Brown cut
41 the water back and everything went to kaput in Moreno Valley. We don’t want
42 that. Let’s consider HOA and let’s build there because we do need that space to
43 be occupied with homes. Thank you.

44
45 **CHAIR BARNES** – Thank you, Mr. Brugueras. Any other speakers?
46

1 **ADMINISTRATIVE ASSISTANT ASHLEY APARICIO** – No, Sir.

2
3 **CHAIR BARNES** – The Applicant. Could he speak within the Public Hearing or
4 outside? Yeah, okay, go ahead.

5
6 **APPLICANT DAN WEBB** – Well, two things I want to say is, first of all, I really
7 want what is best for Moreno Valley. You know, I have a 20,000 square foot lot,
8 and it is a challenge to maintain. If there was some compromise where we could
9 come up with homes or, I don't want 7200 square foot homes, my wife, you
10 know, there's some mix. Like, you know, a third of an acre or quarter acre of
11 whatever you guys want. I'm super flexible. I just want to make the best houses
12 I can in Moreno Valley, so if you guys are interested in giving...letting me have a
13 smaller lot, that would also help on the....having the HOA is probably the scariest
14 thing in the conditions because having 16 people, which is a pretty small group to
15 maintain stuff, makes me a little bit nervous and spreading around those costs
16 over 16. If I could spread it out over, you know, I would pick the number 25 or
17 32; that would be a lot earlier. So I'm open to any ideas. I'm in no hurry. I want
18 the right project for you guys.

19
20 **CHAIR BARNES** – Thank you. With that, we will close the Public Hearing and
21 return to discussion/deliberation. Any questions? I've got a couple but
22 Commissioner Lowell.

23
24 **COMMISSIONER LOWELL** – I have a question. Landscaping along
25 Cottonwood. Who would be maintaining that? Is that City maintained, HOA
26 maintained?

27
28 **ASSOCIATE PLANNER JEFF BRADSHAW** – That is City maintained through
29 the Maintenance District.

30
31 **COMMISSIONER LOWELL** – Okay and the homeowners would pay into it, is it
32 through a tax, in addition to the HOA?

33
34 **ASSOCIATE PLANNER JEFF BRADSHAW** – They would be required to ballot
35 into an assessment district.

36
37 **COMMISSIONER LOWELL** – Thanks

38
39 **CHAIR BARNES** – Do you have a Zoning Map that shows surrounding.....

40
41 **ASSOCIATE PLANNER JEFF BRADSHAW** – Yeah and for some reason, when
42 you go to the slide, it decides to make it this postage stamp size. I'm not sure
43 why it's doing that. I have a print copy I can bring up to you, Chair Barnes.

44
45 **CHAIR BARNES** – Yeah. Well, cutting to the chase, I think what Commissioner
46 Sims might be referencing is appropriate, but I'd like some discussion of it.

1
2 **COMMISSIONER SIMS** – My sample size referencing is very unique to me
3 because I do live in a half-acre subdivision that was developed in the early 90s
4 and then we were out there for years and years and years and then Richmond
5 American came in, and they built probably 300 or 400 homes, 200 to 300,
6 whatever it is. And I remember the Planning Commission meeting, and the
7 developer came in, oh, we're going to put in....they wanted to downsize from the
8 R2 to, I think it was R3, to third-acre lots. It was...I think there were petitions
9 going around my neighborhood. All of my neighbors came in, and they were
10 upset, and they were just, "We want half acre." Well, anyhow, the City went
11 ahead and did the Change of Zone, and I could just....it's.....there's a lot of
12 things. It's not in the PAKO. This is not an area, you know, where's a person
13 going to ride a horse here. I don't know if there's a horse trail that goes...if the
14 trail system goes right through this property but, anyhow, this is kind of in a very
15 urbanized part of the city next to a fairly substantive street with Cottonwood
16 where there is a lot of traffic, so probably it's not an animal husbandry-type
17 neighborhood that you're going to see there. It's just going to be a big lot
18 neighborhood and, if the pricing point is tight, the developer is not going to be
19 able to build an estate-size house to justify the size of the lot. So, anyhow, I
20 could go on and on. The cost of the water to maintain it. The cost to build
21 the....to put in the plant materials and to maintain it and stuff. I don't know, it just
22 seems like.....and then the point with get a dominator bigger to justify the
23 expense of an HOA, I think there's a lot to that. I certainly am not opposed to the
24 project. As is, I would go ahead but I think, if the developer is willing to do a
25 Change of Zone, to do something with a third of an acre, something that is kind
26 of transitional to the R5 from the half acre to match the sizes of the...the east and
27 west sides, I think it would be a good project.
28

29 **COMMISSIONER LOWELL** – The City had an exorbitant amount of applicants
30 coming in front of us trying to cram the most amount of houses on the least
31 amount of space. We approved lots down to 4000 square feet in the
32 neighborhood next to me. I think it is a breath of fresh air that the developer is
33 trying to get some decent-sized lots in the middle of the city, and it fits with the
34 houses to the east and to the west. It doesn't fit with the north and south, but he
35 is not asking for a Zone Change, so I don't even think we should be talking about
36 it because he is asking for a Tentative Tract Map with 16 lots in it. We should
37 discuss what's in front of us, not what we wish they would do or think you should
38 do. I think we should just discuss what's in front of us.
39

40 **CHAIR BARNES** – I don't know. In previous meetings, we don't hesitate to say
41 what we think they should do.
42

43 **COMMISSIONER LOWELL** – But we're not going to be changing what's
44 presented in front of us. That's not even in our purview to change it from 16 lots
45 to something else.
46

1 **COMMISSIONER SIMS** – Yeah, but we could vote no if we don't like it.

2
3 **COMMISSIONER LOWELL** – Why would you vote no on a good project when
4 the Applicant wants it?

5
6 **COMMISSIONER SIMS** – But if it's not the right project, it's part of our job as
7 Planning Commissioners.....

8
9 **CHAIR BARNES** – He's just offered up the opinion that he is open to higher
10 density.

11
12 **COMMISSIONER LOWELL** – Tell me a developer that would not want the
13 flexibility to put 500 homes on one acre. Tell me one developer that wouldn't
14 want to do that. Any developer would like to get the most bang for the least
15 amount of buck.

16
17 **COMMISSIONER SIMS** – I refer you to the book *Basic Economics* by Thomas
18 Sowell. You read that. Market drives what market does.

19
20 **COMMISSIONER LOWELL** – Exactly.

21
22 **COMMISSIONER SIMS** – So I heard the developer say it's tight. We're probably
23 going to see dirt sit out there because this is tight and it might be.....

24
25 **COMMISSIONER LOWELL** – Try and buy a house in the city right now. They
26 are \$400,000/\$500,000 right now. I say let's see what happens. He wants to put
27 16 houses on it. Let's do it.

28
29 **VICE CHAIR KORZEC** – I totally agree. I think...I'm looking at the big picture.
30 We're bringing new industry in. We're trying to attract new people.

31
32 **COMMISSIONER LOWELL** – This is where the CEOs of the Amazon too could
33 live.

34
35 **VICE CHAIR KORZEC** – Exactly. You've got it but, for myself, if I had a choice
36 right now of buying a home with a bigger lot or where I live, I would buy the home
37 with the bigger lot. Some of us come here from parts of the country where you
38 have acreage and you come to California and you live like this and the houses
39 are so close. It is hard to buy homes in this area at a reasonable price that have
40 acreages and lots that are bigger.

41
42 **COMMISSIONER LOWELL** – My house is 10 feet away from my neighbors on
43 each side and 30 feet away from my neighbor in the back. The last two nights of
44 the World Series, I can hear which neighbors are Astros fans and which
45 neighbors are Dodgers fans. They are screaming and yelling and hollering. I

1 don't like that anymore. I want to have a little bit of space. This guy wants
2 space, I say let's vote on it.

3
4 **COMMISSIONER SIMS** – I understand. We have voted for things that, you
5 know, piling 10 houses on what should be....like the stuff that's going in across
6 from the Kia or whatever. I mean, those are private streets, townhouse attached
7 lot, so that's a market driven thing. The developer thinks he can get that knocked
8 out. All I'm saying is the half-acre lots in my particular neighborhood have never
9 achieved the pricing that they should achieve, and they never will because when
10 you drive through the neighborhood 50% plus, probably closer to 80% of the lots,
11 look like Mead Valley because nobody can afford to maintain it, and there isn't an
12 HOA there to enforce it and so if you want to....

13
14 **COMMISSIONER LOWELL** – Why did this Planning Commission

15
16 **COMMISSIONER SIMS** – If you want to have dirt in your front yard, move to
17 Mead Valley.

18
19 **COMMISSIONER LOWELL** – Why did this Planning Commission vote down the
20 project off of Nason and Ironwood? Because it wasn't the right fit. It was too
21 small of lots. We have a person wanting to put larger lots in the neighborhood
22 that's zoned for larger lots. He doesn't want to change the zoning. He wants to
23 put a project in that fits with the zoning, with the neighbors, and we're arguing
24 that he should change it. It doesn't make sense.

25
26 **CHAIR BARNES** – But the same arguments we were using in previous projects
27 because of the high density north and south, you could make the same argument
28 in this case that it is not appropriate.

29
30 **COMMISSIONER LOWELL** – I'm saying he doesn't want to change anything.
31 He just wants a Tentative Map. I'm saying why are we talking about it?

32
33 **CHAIR BARNES** – I didn't hear him say that.

34
35 **COMMISSIONER SIMS** – I heard...I have a package in front of us but....

36
37 **CHAIR BARNES** – Yeah....

38
39 **COMMISSIONER LOWELL** – So we're not here to tell him what he should or
40 shouldn't develop.

41
42 **COMMISSIONER SIMS** – We're not doing that.

43
44 **COMMISSIONER LOWELL** – We're getting way off topic here.
45

1 **CHAIR BARNES** – Well I don't know that we are. I think it's part of the area of
2 our purview to discuss opportunities for each project.

3
4 **COMMISSIONER LOWELL** – He is not arguing anything. He's not asking us for
5 anything special. I don't think that we should grab ahold of trying to design
6 something that's not in front of us. We're not here to design.

7
8 **CHAIR BARNES** – I know. I think we're here to....

9
10 **COMMISSIONER LOWELL** – Had he come in front of a Design Review
11 Committee and say I want to put 32 houses on here that's a whole different
12 ballgame, but he's not asking for that. He's open to the idea and if he wants to,
13 after tonight's meeting drop this case and reapply for a Change of Zone, that's a
14 whole different conversation, but what's in front of us tonight is a Tentative Tract
15 Map. I think we should vote on it as it stands. Nobody out there has discussed
16 any change or any argument of anything.

17
18 **COMMISSIONER SIMS** – I don't disagree. I just wanted to get my two cents in.

19
20 **COMMISSIONER LOWELL** – He is trying to make us earn our stipends.

21
22 **COMMISSIONER SIMS** – But he spent a lot of money getting it to where it's at,
23 so.....

24
25 **COMMISSIONER LOWELL** – Exactly.

26
27 **COMMISSIONER SIMS** – It is what it is.

28
29 **COMMISSIONER LOWELL** – We can armchair engineer for days.

30
31 **CHAIR BARNES** – Well, does someone want to make a motion?

32
33 **COMMISSIONER LOWELL** – I will gladly make a motion. How do you want to
34 do it with the new system? I need to state the motion first?

35
36 **PLANNING OFFICIAL RICK SANDZIMIER** – You should state motion. I think
37 the one thing you might want to include in the motion, if you haven't remembered
38 that, is the change to that one condition.

39
40 **COMMISSIONER SIMS** – Now, we have a motion A1,2 and B1. Do I read them
41 individually or just make a motion for the Resolution?

42
43 **CHAIR BARNES** – The Resolution is enough, right?

44
45 **COMMISSIONER SIMS** – The Resolution is okay?

46

1 **ASSISTANT CITY ATTORNEY PAUL EARLY** – You can read the whole thing if
 2 you like. I've often recommended for brevity, you can just recommend the first
 3 part before the colon on A and on B. You want to do both of those, at least that
 4 much.

5
 6 **COMMISSIONER SIMS** – I would like to make a motion to approve Resolution
 7 No. 2017-34 and approve Resolution 2017-35 with the Conditions of Approval as
 8 recommended tonight.

9
 10 **VICE CHAIR KORZEC** – I second.

11
 12 **CHAIR BARNES** – I have a question on the amended conditions. What does
 13 that include? What have we amended?

14
 15 **ASSOCIATE PLANNER JEFF BRADSHAW** – In Condition P9, we would be
 16 deleting the reference to the document to convey title. We would delete that from
 17 that condition.

18
 19 **CHAIR BARNES** – Alright. I would....

20
 21 **PLANNING OFFICIAL RICK SANDZIMIER** – It's line A. For the record, it's line
 22 A of that Condition.

23
 24 **CHAIR BARNES** – If I want to propose another amendment to the conditions, is
 25 that an alternate motion or how do we do that?

26
 27 **ASSISTANT CITY ATTORNEY PAUL EARLY** – It would be an alternate motion
 28 unless you could convince the mover to add it to his original motion.

29
 30 **CHAIR BARNES** – Ah, I haven't been able to convince him of anything else
 31 tonight, but I'll put it out there. I would also like to add a condition requiring the
 32 slope between lot 16 and 15 to be moved to the south so that the top of slope is
 33 on the property line, not the top of the slope.

34
 35 **COMMISSIONER LOWELL** – I do agree with that. Would that be a Lot Line
 36 Adjustment to move it over, or would the slope be moving?

37
 38 **CHAIR BARNES** – No, we'd just....

39
 40 **ASSOCIATE PLANNER JEFF BRADSHAW** – That would be....

41
 42 **CHAIR BARNES** – Just revise the Grading Concept to put the slope on the other
 43 side of the line, right?

44

1 **TRAFFIC ENGINEER MICHAEL LLOYD** – That’s correct. It would be a plan
 2 check comment once we move forward with the project, and we would relocate
 3 the slope, so that the property line could stay as shown.

4
 5 **COMMISSIONER LOWELL** – Okay, so would I make a condition on that or how
 6 would I do that?

7
 8 **ASSISTANT CITY ATTORNEY PAUL EARLY** – No, you just state that you’re
 9 moving with the conditions that we have just set forth.

10
 11 **COMMISSIONER LOWELL** – Okay, I would like to amend my motion to include
 12 the condition set forth by Chairman Barnes.

13
 14 **ASSISTANT CITY ATTORNEY PAUL EARLY** – Do you still have a second for
 15 that?

16
 17 **VICE CHAIR KORZEC** – Yes.

18
 19 **CHAIR BARNES** – Having a motion and a second, please vote. The motion
 20 carries 5-0.

21
 22
 23 Opposed – 0

24
 25
 26 **Motion carries 5 – 0**

27
 28
 29 **PLANNING OFFICIAL RICK SANDZIMIER** – This is an action taken by the
 30 Planning Commission, which is an appealable action. If there is any party that
 31 feels that they want to appeal this, this is a Subdivision Map, so it has a 10-day
 32 appeal period. The appeal should be directed to the Director of Community
 33 Development, and it would be scheduled to go before the City Council for a
 34 hearing within 30 days, if such an appeal is filed.

35
 36 **CHAIR BARNES** – Thank you, Rick. Commissioner Sims.

37
 38 **COMMISSIONER SIMS** – I don’t disagree Brian at all with your statement that
 39 we should vote for what we did. I think we all made a good decision on this, but I
 40 do want to just say I do think it’s right for us to have this kind of conversation,
 41 especially on something like this where a developer could decide after he hears,
 42 oh, I may want to do something before he moves forward. Also, it provides, if
 43 anybody is listening out there, they could provide input into future projects, and
 44 also it could be a message to the City Council in making considerations in things
 45 like that. So, the discussion, I don’t think may be off point, per say, because
 46 we’re not going to change the conditions; say, oh no, we want you to put in three

1 lots there or whatever or houses to the acre. But I think, for the record, to create
2 the deliberation on some things for potential forward change is worth the effort.

3
4 **COMMISSIONER LOWELL** – Yeah, I agree, and I understand. I kind of had a
5 feeling that we were going down a way of not approving this project because we
6 wanted to force them to do a Zone Change, and I was just trying to pull us back
7 on point, but I completely agree, and I completely understand.

8
9 **COMMISSIONER SIMS** – There’s always battles to win wars.

10
11 **CHAIR BARNES** – Waxing philosophical. That a boy. Alright, moving onto
12 Case 2, PEN17-0115. Applicant is the City of Moreno Valley. Good luck getting
13 this approved.

14

15

16

17

- 18 2. Case: PEN17-0115
- 19
- 20 Applicant: City of Moreno Valley
- 21
- 22 Owner: City of Moreno Valley
- 23
- 24 Representative: Community Development Department
- 25
- 26 Location: City-wide
- 27
- 28 Case Planner: Claudia Manrique
- 29
- 30 Council District: All
- 31
- 32 Proposal: A City-wide Municipal Code (Title 9)
- 33 Amendment addressing Land Use Regulations
- 34 for Accessory Dwelling Unit (ADU) (formerly
- 35 Second Dwelling Units) to ensure compliance
- 36 with new State of California laws.
- 37
- 38
- 39
- 40

37

38

39

40

41 **STAFF RECOMMENDATION**

42

43 Staff recommends that the Planning Commission **APPROVE** Resolution No.
44 2017-33 and thereby:

45

- 1 1. **FIND** that PEN17-0115 (Municipal Code Amendment for Accessory
2 Dwelling Units) qualifies for a Statutory Exemption in accordance with
3 CEQA Guidelines, Section 15282(h) and;
4
- 5 2. **RECOMMEND** that the City Council approve the proposed amendments
6 to Title 9 of the City Municipal Code, PEN17-0115.
7

8
9 **PLANNING OFFICIAL RICK SANDZIMIER** – That’s what I was going....I was
10 hoping you weren’t going to say that, but this is a City-initiated change to the
11 Development Code and Claudia Manrique, our associate planner, will be making
12 the presentation.
13

14 **ASSOCIATE PLANNER CLAUDIA MANRIQUE** – Good evening. This is a City-
15 wide Municipal Code Amendment to Title 9, addressing what was formerly known
16 as the second dwelling unit. SB1069 and AB2299 were approved last year in
17 September and became effective in January of this year. Both bills renamed
18 second dwelling units to accessory dwelling units, also known as ADU’s. Staff
19 proposed to amend the existing ADU Ordinance in order to comply with State
20 Law. Currently any ADU’s that come in would be processed under the State
21 Regulation and this is until Moreno Valley updates its Ordinance. There are a
22 few of the proposed changes that are going to the Section 9.09130, the three-
23 dwelling section unit now. We’re adding some definitions. This includes some
24 cleanup of the permitting processing. We have some Development Standards
25 for efficiency units of some added restrictions for fire safety, along with some new
26 parking requirements. Major changes, besides the name title to accessory
27 dwelling unit, is adding two definitions to both the section of ADU’s as well as the
28 definition section of the Code. Accessory dwelling units can be either attached or
29 detached and must include sleeping areas as well as a kitchen and sanitation.
30 Efficiency unit is new. It is only in attached units. It has a minimum square
31 footage of 150, so it’s rather small. It can have small bathroom facilities and
32 does not need to have a full kitchen. The State has opted to give residents who
33 are developing at ADU some exemptions from parking. There are five of them.
34 This is...will help with units that are near transit stops as well as ones that are
35 potentially near car sharers. Some of the additional requirements that are being
36 addressed in tonight’s proposal is the maximum size is 1200 square feet.
37 Attached ADU’s cannot be greater than 50% of the existing space. ADU’s are
38 permitted on single-family lots as well as multifamily lots with existing single-
39 family homes. Existing accessory structures may be converted to an ADU. This
40 proposal is exempt under CEQA, and Staff recommends approval of Resolution
41 2017-33. It finds that the proposed amendment is exempt under CEQA Section
42 15282H and recommends that the City Council approve the proposed
43 amendments to Title 9. Thank you.
44

45 **PLANNING OFFICIAL RICK SANDZIMIER** – If I may, Mr. Chairman. I want to
46 just add a little bit of additional background. The reason this is before us this

1 evening is not because the City itself wanted to come up with some new
2 standards for second units or accessory dwelling units, this is really forced on us
3 by the State. The State, as you have probably read over the last year and even
4 years before that, has been looking at ways to facilitate and to remove obstacles
5 for making it easier for people to get access to housing. The accessory dwelling
6 unit is considered to be an opportunity for people who are looking for what might
7 be affordable housing opportunity to do that as well. The accessory dwelling unit
8 is the same thing as a second dwelling unit. We had in our Ordinance before
9 where it can be rented out to somebody else. You still have to have the primary
10 owner of the site either residing in the accessory dwelling unit or in the primary
11 home, so you have to have the property owner on the site, but the reason for the
12 second unit is to possibly generate some revenue so that that homeowner, the
13 property owner, can actually generate some revenue. I will say that the
14 accessory dwelling unit standards were somewhat derived from really a Northern
15 California focus, and so a lot of the focus seems to be on smaller compact
16 developments that are closer to transit opportunities that don't necessarily need
17 parking requirements. The parking allowances that are in this are a pretty
18 significant change. Pretty much any unit that comes into the city is probably
19 going to be in one of those categories and may be able to request relief from the
20 parking requirement, and we just want you to know that it is not because we want
21 to give away the parking requirement. We are going to be forced to actually do
22 that because we have to comply with the State Regulations. The other thing I
23 want to point out is you may recall that this second dwelling unit or accessory
24 dwelling unit topic did come up a while back and, as Claudia has pointed out in
25 the presentation, the State Law was actually being crafted back in 2016. It was
26 actually approved in, I think, September 2016, and it went into effect in January
27 of this year. During that time, the City Council was interested in possibly getting
28 a study session on accessory dwelling units for various reasons; a lot of other
29 things going on. That study session with the City Council never took place and
30 so, instead of holding off and not updating our Ordinance because our Ordinance
31 does need to comply with the State Regulations, we have moved forward with
32 making the change to our Code to just make sure that we are compliant with the
33 State Regulations. The item before you, I'm not sure that Claudia pointed out in
34 the Staff Report, is that your action tonight is in an advisory capacity because this
35 is a change to the Development Code, which ultimately requires City Council
36 action. So, after your action this evening, we will be taking that recommendation
37 forward to the City Council for the final action.

38
39 **CHAIR BARNES** – Thank you, Rick. Anybody have any questions?
40

41 **VICE CHAIR KORZEC** – I do. Does this relate in any way to these rentals that
42 people do online for like you can use somebody's apartment for a week or two
43 weeks and how does that affect a neighborhood, rather than a person being
44 there over long-term?
45

1 **PLANNING OFFICIAL RICK SANDZIMIER** – It does not fall under the category
2 of like an Air B&B...

3
4 **VICE CHAIR KORZEC** – Yeah.

5
6 **PLANNING OFFICIAL RICK SANDZIMIER** – Where people are doing short-term
7 rentals or renting the rooms on a short-term basis. That's not the intent. I did talk
8 with our Finance Staff this afternoon about that particular topic. We don't have
9 any regulations with regard to that topic, but this is not something that we think is
10 in that realm at this point.

11
12 **CHAIR BARNES** – Commissioner Sims.

13
14 **COMMISSIONER SIMS** – For context purpose, how many of the secondary units
15 are processed through the City prior to this change? Is it a little, a lot, on an
16 annual basis, perhaps?

17
18 **ASSOCIATE PLANNER CLAUDIA MANRIQUE** – I don't have an exact number
19 but approximately two to three a year, not too many.

20
21 **CHAIR BARNES** – What differentiates an efficiency unit from somebody who is
22 renting out a bedroom to a college student?

23
24 **PLANNING OFFICIAL RICK SANDZIMIER** – The distinction would be the
25 efficiency unit does have to have at least a partial kitchen and a bathroom facility
26 that is for that particular unit itself; where somebody could be renting a room,
27 may be actually using the kitchen facility or the bathroom that is part of the main
28 house. That would be one clear distinction. The efficiency unit, if it is treated as
29 an accessory dwelling unit, I believe, correct me if I'm wrong Claudia, cannot
30 have a direct access to the primary residence. It has to have its own entrance.
31 Whereas, somebody who is renting a room, can go through the regular front door
32 and any other door into the house, and so there is no distinction there. That's
33 two things or at least three things.

34
35 **CHAIR BARNES** – Okay and then something caught my eye about the written
36 agreement with the City that is required when I guess an applicant applies for an
37 accessory dwelling unit or an efficiency unit, what's the...what's the purpose of
38 that agreement? What is it stipulating?

39
40 **PLANNING OFFICIAL RICK SANDZIMIER** – That agreement is actually being
41 carried forward in our current regulations, and it basically is a contract, so to
42 speak, almost where we know that the Applicant is acknowledging that these are
43 the requirements for having this second unit consistent with our Municipal Code.
44 We think that is important to continue to have. It's not a requirement of the State
45 Regulations. It's something that is actually being carried forward from our current
46 regulations.

1
2 **CHAIR BARNES** – Okay, alright. I was just curious where that came from.
3 Okay, Commissioner Sims.

4
5 **COMMISSIONER SIMS** – Yeah, I noticed when I was reading through the
6 materials that it appears that there is a....if somebody wanted to convert a
7 garage into axillary.....

8
9 **CHAIR BARNES** – Efficiency unit.

10
11 **COMMISSIONER SIMS** – Efficiency unit, let's say, because it would be attached
12 to the house. How does the City handle that? I mean is there....through the
13 administrative plan check process, there would be a requirement for a carport or
14 some kind of other thing to replace the covered parking that was already
15 designated for the single-family residence that had that?

16
17 **ASSOCIATE PLANNER CLAUDIA MANRIQUE** – The State doesn't allow...if it's
18 going to be an attached unit, we can't place any parking requirements on the
19 project or any additional parking so.....

20
21 **COMMISSIONER SIMS** – You said if it's going to be what kind of a unit?

22
23 **ASSOCIATE PLANNER CLAUDIA MANRIQUE** – Attached. Detached still has
24 the requirement of one parking space per bedroom unless it meets one of the
25 five exemptions, which they need to provide with their application. So if they
26 came in and said, we're within a half mile of a bus stop, they need to show us
27 what distance and what bus stop they would be using.

28
29 **COMMISSIONER SIMS** – So when somebody would come over and say I'm
30 going to convert my two-car garage into whatever this 450 square feet or
31 whatever it is attached, the largest could be, probably not a whole garage, a
32 garage bigger than that, I'm not sure off the top of my head but, anyhow, long
33 story short is that would have to go through the Title 22 calculations for the air
34 conditioning and all that kind of stuff. It couldn't just be close up the front garage
35 door, wall that in, and.....

36
37 **ASSOCIATE PLANNER CLAUDIA MANRIQUE** – Right. It would need to come
38 in as Administrative Plot Plan, so Planning would be reviewing what the new
39 elevation would look like as well as going through the building process.

40
41 **COMMISSIONER SIMS** – And this, this, I mean I'm not against this, but it seems
42 like there is the potential....what was the prior thing when you have to have
43 three, three onsite parking. I think you better codify that pretty quick; otherwise,
44 this is going to be challenging potentially but, if there is only two of them a year or
45 something like that....

1 **CHAIR BARNES** – Anything else?

2
3 **COMMISSIONER LOWELL** – How is the distance to the nearest parking or
4 nearest public transit station measured? Is it straight line or is it as you...along
5 path of travel?
6

7 **PLANNING OFFICIAL RICK SANDZIMIER** – I actually went to training on this
8 one. It's really ambiguously defined. A lot of the cities are very concerned about
9 the way the State wrote the regulations because it just says you have to be
10 approximated to transit. If somebody wanted to come in and make an argument
11 that is to a bus stop or to a transit stop or somebody could also come in and say,
12 no, that's just proximity to a bus line, and it happens to be a bus line that runs
13 through my neighborhood, and I want to make that argument. We're asking that
14 the Applicant be required, and that's one of the things Claudia was touching on
15 was, we're going to make it a requirement of the Applicant to demonstrate to us
16 how they are meeting any of those five criteria, and so we hope that is going to
17 give us a little bit more opportunity to evaluate that circumstance and discuss it
18 with the applicant's and maybe, over time, the state will actually make some
19 clarifications on that but, right now, it's a very grey area. I'm sorry. I cannot give
20 you a definitive answer on it.
21

22 **COMMISSIONER SIMS** – Okay.
23

24 **CHAIR BARNES** – Building on what Commissioner Sims was saying,
25 hypothetically, what's the difference between a guy who comes in and says I
26 want to add an efficiency unit by converting my garage to two bedrooms or
27 whatever and a guy who comes in and says I want to convert my garage to two
28 bedrooms? Is either process acceptable or does he have to use the "E" word
29 and then he has to sign the contract with the City and all these regulations come
30 into play or he can just do a building modification and end up with the same
31 physical product but not the criteria that comes with calling it an efficiency unit?
32

33 **PLANNING OFFICIAL RICK SANDZIMIER** – If he wants to consider it, instead
34 of calling it an efficiency unit, let's call it an accessory dwelling unit because an
35 efficiency unit is a form of an accessory dwelling unit, so the accessory dwelling
36 unit will have to have the standards. It has to have its own entry and own
37 entrance to the living unit. He will have to come in and go through all the
38 Building and Fire Codes and has to be established as a unit that has a bathroom
39 facility and at least a partial kitchen. That'll be confirmed instead of just
40 converting it to two bedrooms. If somebody just wanted to come in and convert
41 the garage to two bedrooms, they are going to be held to the requirement that
42 they do have to replace the parking that's required for the unit. That's going to
43 be automatic. I'm sorry. It's going to be an automatic requirement to replace the
44 parking if it is an addition of bedroom space but, if it is an addition of an
45 accessory dwelling unit and they can satisfy one of the other five exemption
46 criteria, then the parking may not have to be replaced but, if it is just adding

1 bedrooms, they are going to have to replace the parking. I don't know if that's
2 coming across clear or not.

3
4 **CHAIR BARNES** – Well, maybe I'm not understanding all of it. It seems like
5 there is this huge grey area between a guy making improvements and not calling
6 it an efficiency unit or, whatever the term was, and a guy who does and I'm
7 just....

8
9 **COMMISSIONER SIMS** – I think the distinguishing characteristic between the
10 efficiency unit and a conversion of your garage to two bedrooms is the fact that, if
11 he wants to get the efficiency unit approved, he has to have a separate entry into
12 the property and it has to have its own.....

13
14 **COMMISSIONER LOWELL** – Kitchenette.....

15
16 **COMMISSIONER SIMS** – Kitchen and little kitchenette and a bathroom, so, so
17 and then he can....then that owner can then, if he can meet the exemptions for
18 the parking, wiggle out of the replacement of the garage parking. If he wanted to
19 just come in, and I have a two bedroom house, and I'm going to have two more
20 kids, and I need four bedrooms and I'm just going to put....make my garage into
21 two more bedrooms. He's not going to have....and he goes through....doesn't
22 just do it on the weekend job and comes in and permits it, then he is going to
23 have to go build a carport of whatever the City requires for replacement of the
24 covered parking.

25
26 **CHAIR BARNES** – It seems like an odd circumstance that has the potential for
27 some unintended consequences but we're here to just advise, and I don't think
28 that in the long-run it matters that much. So, any other questions? Does
29 somebody want to make a motion?

30
31 **COMMISSIONER SIMS** – I'll make a motion. Let me find it here real quick.
32 Being that this is a requirement of the State of California.....

33
34 **PLANNING OFFICIAL RICK SANDZIMIER** – Hold on, hold on. This does
35 require a Public Hearing.

36
37 **COMMISSIONER SIMS** – Oh, I'm sorry.

38
39 **CHAIR BARNES** – My apologies. The Chair has dropped the ball again. So,
40 having no further questions, I would like to open the Public Hearing. Do we have
41 a speaker?

42
43 **ADMINISTRATIVE ASSISTANT ASHLEY APARICIO** – Yes, we do, Rafael
44 Brugueras.

45
46 **CHAIR BARNES** – Mr. Brugueras, please come forward.

1
2 **SPEAKER RAFAEL BRUGUERAS** – Thank you, Chair, Commissioners, Staff,
3 you know when you sit back there and you start listening to some of the
4 confusion that goes on, you’re going to have a lot of lawbreakers because it’s a
5 lot easier just to break the law and make it a two bedroom apartment and don’t
6 tell nobody. You’ll have those. Okay? Because if somebody is going to have to
7 go through what you just mentioned, the private entrance or remodeling the
8 garage and two bedroom and going through a carport and everything, they’d
9 rather just say thank you and walk away and just still do it, and I’ve seen plenty of
10 those, especially when you knock on peoples doors campaigning. You see who
11 opens the door and what door opens, so you have a lot of that, okay. So that
12 was a really tough one. Now, I like people to be able to build homes or another
13 dwelling place behind their existing home, but I never thought....I’m not thinking
14 of tract homes. I’m thinking of the R2’s, R3’s, R4’s, and R5’s because there are
15 plenty of them in Moreno Valley, and some of them may want to build a second
16 home, like one of the slides. Because the door was open today to that 10 acre,
17 20,000 square feet, he has the right. Those people have the right to build a
18 home in the back because, anything over 7200 square foot, you have the right to
19 pull a permit and see if you’re able to put a house in the back. So in one of those
20 slides it had a nice little blue house with green trimming and a brown fence, and I
21 looked at it and, I said, there it goes. A 20,000 square foot lot with a little house
22 on the back. That could happen on Cottonwood because we just agreed to it.
23 Mr. Sims, if he would have persuaded, and he did. He did persuade the
24 Applicant for a moment to go down a little smaller, okay? You know, one-third is
25 pretty big too, and he was being real honest about his neighborhood and some of
26 his neighbors. It would’ve been nice to see a one-third, maybe 25, 32 houses.
27 Ten thousand acres is a lot. I live on a 10,000 acre lot, and do you know how
28 much money it costs to cement that alone? That’s not counting a pool, or the
29 deck, or the carport, or the port in the back, nothing. That’s a lot of money, so I
30 hope that you approve this; not to see track homes but homes in the back
31 of....but people that have a lot of acreage so they can get a chance or if we could
32 have a chance to change someone’s mind for the better good of the City, we
33 should talk about that.

34
35 **CHAIR BARNES** – Thank you, Rafael. Alright, any other speakers? It doesn’t
36 appear so. It’s very empty out there. With that, we will close the Public Hearing.
37 Now, would we like to deliberate, make a motion?
38

39 **COMMISSIONER SIMS** – Well, I would say this is an unfunded mandate from
40 the State of California to create more Code Enforcement work for our fine City
41 Staff but, so be it, but its legislation so you have to do what you have to do, so
42 I’m willing to make a motion to approve it. I think it’s pretty....I think Staff did a
43 good job. It’s pretty thoughtful and adjusting the 1250 to 1200, I think they dotted
44 the “I’s” and crossed the “T’s” on this thing to fit, at least the spirit of what the
45 State has mandated.
46

1 **PLANNING OFFICIAL RICK SANDZIMIER** – So the motion when it is made, if
 2 he is making a motion, would be a recommendation to the City Council to
 3 approve it because you guys won't be the approval body.

4
 5 **COMMISSIONER SIMS** – So I don't know if there is any other deliberation but
 6 I'm willing to make.....

7
 8 **VICE CHAIR KORZEC** – I'll make the motion.

9
 10 **CHAIR BARNES** – Anyone want to second?

11
 12 **ASSISTANT CITY ATTORNEY PAUL EARLY** – Is that a motion to approve both
 13 the Resolutions before you?

14
 15 **COMMISSIONER SIMS** – Yes, I would recommend the Planning Commission
 16 approve...recommend approval of the Resolutions that are under consideration
 17 here and for City Council approval for consideration.

18
 19 **COMMISSIONER BAKER** – I'll second.

20
 21 **CHAIR BARNES** – A motion from Commissioner Sims. A second from
 22 Commissioner Baker, so let's vote.

23
 24 **VICE CHAIR KORZEC** – I don't have a voting thing.

25
 26 **CHAIR BARNES** – Oh, hit your...bear with us.

27
 28 **COMMISSIONER LOWELL** – So, for clarity, we're motioning to approve the
 29 Resolution PEN17 or 2017-33....

30
 31 **CHAIR BARNES** – Oh, in that case, I'll vote. All votes have been cast. The
 32 motion carries 5-0. Do we have a wrap-up?

33
 34
 35
 36 Opposed – 0

37
 38
 39 **Motion carries 5 – 0**

40
 41
 42
 43 **PLANNING OFFICIAL RICK SANDZIMIER** – The item before you is a legislative
 44 action, which requires a City Council as the ultimate approval of authority on this.
 45 Your recommendation will be carried forward to the City Council for that action.

1 We don't yet have a date set, but we do expect it will probably be before the end
2 of the year.

3
4 **CHAIR BARNES** – Thank you, Rick. Next on the Agenda, Other Commission
5 Business. Do we have any Other Commission Business?
6

7
8 **OTHER COMMISSION BUSINESS**
9

10
11 **PLANNING OFFICIAL RICK SANDZIMIER** – No, there is no other Commission
12 Business. Sorry.
13

14 **CHAIR BARNES** – There is no other Commission Business. Staff Comments?
15

16
17 **STAFF COMMENTS**
18

19
20 **PLANNING OFFICIAL RICK SANDZIMIER** – Yes, thank you, Chair Barnes.
21 Looking at the lightness of the Agenda tonight, but we've had a lot of discussion,
22 I did put together a few slides just to kind of bring the Commission up to speed
23 on the activity that's been going on in the city over the last year. It'll take me a
24 few minutes and, if you want me to go faster, I'll be happy to do so. There's no
25 action to be taken on this particular presentation this evening. It's really for
26 information purposes since we haven't met in a couple of months, and there's
27 been a lot of activity going on in the city. People at home watching might enjoy
28 seeing this as well. It gives a flavor of what we're pretty proud of here at the city
29 in terms of the economic development and activity we've been generating. Okay,
30 so as an activity overview, what I'm going to cover is residential development,
31 commercial development, and some industrial development, building major
32 permits that have been issued. We issue lots of minor permits every day, so I'm
33 not counting all those. These are really kind of the major ones that you see out
34 there. Residential units, 218 residential permits have been issued in the last
35 year. The commercial permits are 37. I apologize, the slide, I think it got
36 reformatted when we put it up here. Hotels, we've permitted one, but we've got
37 three other ones in the works that we hope to have permitted very soon. And
38 then industrial development, these are the large-scale industrial, developments
39 that we've had. We've had two major projects permitted. On the residential side,
40 this is an example of some of the phases of where the construction is. This is a
41 Lennar development up at Pigeon Pass just north of the high school. Some of
42 those units are still in the framing stage. Some of them are in the closer to
43 completion with the finishes on the exterior, the roofing being put on, and I
44 believe that some of the units there are already close to putting in the
45 landscaping, so that development is moving pretty rapidly, and they are phasing
46 it in pretty nicely. Pacific Communities has some completed homes in the area.

1 RSI also has some completed homes,so we've got some of the people already
2 moving into. I think that image on the right shows the completed homes with the
3 front yard landscaping and one of the units with the garage door open shows the
4 people have already moved in. A while back, the Commission had asked some
5 questions about the landscaping in the new homes. I hope that this is better than
6 what we had seen the last time we brought this. It still may look a little bit sparse,
7 and I did get some questions asked about some of the recent projects that we've
8 signed off on the landscaping. We're still trying to follow a drought-tolerant
9 landscaping, but the planting materials that are being planted here are supposed
10 to be faster growing and hopefully, over a short period of time, they will fill in. So
11 it may look sparse, but the idea is to make them more robust, and I've been
12 working with the staff to make sure that we are encouraging the residential
13 builders to, now that we're not in a drought condition, be thinking of maybe some
14 more attractive landscaping. Just, overall, those 218 units are represented by
15 several homebuilders. We've got RSI out there, KB Homes, Lennar, Frontier,
16 Pacific Communities, and Metric Homes. So we're not just attracting one, we're
17 attracting multiple homebuilders. New residential projects that are not yet in
18 construction but have been before you as a body or one that are currently
19 pending. This is the number of homes that you guys have looked at, Mission
20 Pacific was the Legacy Park project, Rocas Grandes, Bella Vista, Chara Villa,
21 were all apartment projects. And then the bridge development, which is the
22 current proposal on the Moreno Valley Ranch Golf Course. They are looking at
23 about 416 units on the driver range that is still going through the process and
24 should be becoming before you in the next few months we hope. Commercial
25 and retail development, you may have heard our Economic Development Team
26 touting the success we had with what is called the Quarter Project. The Quarter
27 Project is a mixed-use development of some sorts. It has a gas station with a
28 convenient store attached to it. It has two potential restaurant pads, one
29 multitenant building, and then the key on that site is two hotel sites, and one of
30 those hotel sites has already gone through the permitting process and the site is
31 currently being graded, and it shows the current grading activity. We're very
32 proud that we've been able to attract the new auto dealership. This is Hyundai,
33 which is getting close to opening. They haven't actually set the opening date, but
34 we think it will be may be before the end of the year, so that's what this one is.
35 On the commercial side, we also have continued development over in the Town
36 Gate area. The Town Gate Promenade area is the area close to where
37 Applebee's and Mimi's and Tilted Kilt and the new Aldi's market went it. Well,
38 right in that same parking lot, if you've been over there lately, you'll see this pad
39 that's being built on, and this will have three potential tenants in the future. We
40 know who two of the potential tenants are but, because they haven't actually
41 gone public, we don't want to say it in public and kind of spoil their thunder or
42 steal their thunder. In addition, just activity going on in all of our other shopping
43 centers at Canyon Springs Plaza, we've issued permits for a variety of new
44 businesses. We've got Country Inn & Suites, which is one of those new hotels
45 that we think is going to be going into construction here pretty soon. This is over
46 in the village area off of Sunnymead Boulevard right adjacent to SR60. It was

1 entitled many years ago, but they are now moving forward, and we think it's
2 going to be a nice attractive addition to Sunnymead. The Golden Corral is one
3 that I am, I guess, maybe going ahead of....I think this has been publicized so I
4 am putting it out there but Golden Corral is looking at another site along
5 Sunnymead Boulevard just west...or just east of Chuck E. Cheese. Moreno
6 Beach Plaza, we had a new AT&T store open in and another restaurant in the
7 Moreno Marketplace. Commercial activity that is not retail, we are seeing some
8 activity with medical-type uses, the Riverside University Health System. This is a
9 200,000 square foot medical office building, which has been approved in the
10 parking lot right next to the hospital. They are going through Planning Check,
11 and they've actually allowed us an opportunity to review the onsite development.
12 So that's good, and they are also going through the state architect for their
13 approval of their building. And then you guys saw recently the Main Street
14 Transitional Care Facility, which is a 90-bed facility, which was approved, was
15 entitled. They haven't come in yet for development, and we're not sure if they
16 are going to, but it's approved, so it's entitlement on the site, and we'll see what
17 happens with that. On the industrial side, we are still seeing continued
18 development for large-box logistic-type facilities. These images, or the one that
19 is right here close to the Civic Center right across the street, has been going up
20 pretty fast. It's a little over 600,000 square feet and then, just a little further east
21 of that, we recently brought a project before you by Core 5, this is a 99,000
22 square foot, almost 100,000 square-foot building, which is going through
23 Planning Check, so we see that they are going to be breaking ground pretty soon
24 also. In the south industrial area, I don't have any images of these, but you can
25 see the size of these developments that are progressing, going into construction,
26 is pretty significant and then last, but not least, the other stuff I was telling you
27 usually comes through our current Planning Group, and that's Chris Ormsby's
28 team. So he has been very active but, on the Advanced Planning Side, and I've
29 got Mark Gross here this evening. He has been equally busy and maybe even
30 more so in some regards with getting our Comprehensive General Plan off the
31 ground. We did release the RFP in October. We're expecting to get proposals
32 here November 9, 2017. We will be negotiating that contract and hopefully
33 issuing a notice to proceed right at the beginning of the year, and it is a very
34 aggressive schedule. It is tied to the Strategic Plan that the City Manager and
35 the City Council worked very hard at approving back in August 2016 and, in that
36 document, it targets the completion of the General Plan Update by August 2019.
37 So we are going to try and be very firm on meeting that deadline. In addition,
38 we've done some studies on Nason Corridor before, but the City owns about 65
39 acres of land at the corner of Nason and Alessandro. We were able to secure a
40 grant, which I think I've told this Commission in the past, it has taken a little bit of
41 time to go through the SKAG (Southern California Association of Government)
42 process to actually procure a consultant but that is in progress. We are actually
43 very, very close. Claudia has been working very hard and Mark is also involved
44 in that. Once we get the consultant started, they've given us a year to finish it
45 but, because of the information that will come out of it, it will be tied to the
46 General Plan Update. We are going to be pushing that to get done closer to like

1 a nine-month period of time. Also, we are happy to say that we've been able to
 2 secure some additional outside grants. This one is about \$65,800 from Western
 3 Riverside Council to Governments. The money was secured just a couple of
 4 months ago, and we're now in the consultant selection process. The RFP will go
 5 on the street, I think, within the next week. We hope to do that in a very timely
 6 fashion and, again, because of the Healthy Community Study, we'll be feeding
 7 into the health element that we're trying to develop in the General Plan. We want
 8 to get that done also in a very timely manner, so I've put up here 9 months, and
 9 that'll be a very aggressive schedule. I think that is my last slide. Maybe not.
 10 I'm sorry. The last slide here is, in addition to the other work that we're doing
 11 here for our own City, we have to monitor what goes on around us. And so, on
 12 Mark's team, there's a lot of Notice of Preparation's that come in, EIR
 13 documents, sometimes Mitigated Negative Declarations for projects that are
 14 going on in the City of Riverside, the County of Riverside, the City of Perris,
 15 March AFB, are the ones right around our border, but we don't stop there.
 16 Sometimes, if we see something that is large enough that has the potential of
 17 causing some impacts in our City, we'll actually comment on those as well and
 18 there was recently one in the County of Riverside. Actually, I think it was the
 19 County of San Bernardino, it might be, which is up off the 10 Freeway, just over
 20 in the Beaumont/Cherry Valley area that we were looking at. If you've read in the
 21 newspaper, it's a pretty large facility. Then we also track legislation, and we also
 22 follow the CEQA regulations, and this is kind of a joint effort between both our
 23 Advanced Planning and Current Planning Teams. So we're staying pretty busy.
 24 What I didn't show up here was the amount of activity that comes through our
 25 Development Services Center, and last year we continued to implement the
 26 Simplicity System. The Simplicity System is our development tracking system
 27 and our permitting system that is making our activities much more transparent,
 28 so applicants can actually log on and see what's in the hopper. Hopefully, in the
 29 future as that thing continues to grow, we'll actually be able to see how it is
 30 progressing and where it is at and maybe even be able to see some of the
 31 documents where we can load them up into the system, so that's been working
 32 very well. With that, I will stop, and it is a nice evening. I know that some people
 33 may want to get off to places. It's still an early hour, so.

34
 35 **CHAIR BARNES** – Thank you, Rick. I appreciate all the info. It seems that a lot
 36 is going on in the city, and that's a good thing.

37
 38 **COMMISSIONER SIMS** – Do you make this presentation to the Council?
 39

40 **PLANNING OFFICIAL RICK SANDZIMIER** – I have not. I don't want to take the
 41 credit for this being my great idea. This was actually your Chairman who thought
 42 that we could use some of the time on the Agenda this evening to make you guys
 43 aware, so I appreciate Chairman Barnes asking me to make this. It actually
 44 makes me feel good about what we're doing because sometimes we get lost in
 45 the heat and you don't really realize how much is going on.
 46

1 **COMMISSIONER SIMS** – Well, I don't speak for the other Commissioners, but I
 2 think this is...I mean, as the sea rises, all the votes go up and so when you see
 3 this kind of...that's significant activity, and I particularly like the whole medical
 4 health thing. I think the city, I mean, I know we have our logistics stuff and all
 5 that, but I really think that that's, you know, the economic development arm
 6 should really hammer at trying to get as much as they possibly can and get as
 7 much synergy out of that. Those are higher-skilled jobs and put a lot of people to
 8 work, even with the care-facility type things. People need help and why not have
 9 Moreno Valley provide that help. So, anyhow, I would think that it would be very
 10 good to have the presentation made to the Council to let them know what's going
 11 on. I mean, they probably already...they do know what's going on, but it's good
 12 at the Council meeting. There's a little bit more notoriety and attendance and
 13 whatnot so.

14
 15 **CHAIR BARNES** – Thank you, I agree totally. Anybody else?
 16
 17
 18

19 PLANNING COMMISSIONER COMMENTS

20
 21 **CHAIR BARNES** – Any wrap-ups? Alright.
 22
 23
 24

25 ADJOURNMENT

26
 27
 28 **CHAIR BARNES** – Well, Staff, thank you very much. I appreciate your patience
 29 and your help, and I guess, with that, we will adjourn the meeting until the.....
 30
 31

32 **PLANNING OFFICIAL RICK SANDZIMIER** – Can I just add one thing? We are
 33 going to have a meeting on November 9, 2017. It will be a very light Agenda at
 34 this point, but we have one project that came in very fast. We're going to
 35 process it. It has to do with repainting a building. It may seem kind of simple, but
 36 we'll have one item on your Agenda. It's the large building down here at the end
 37 of Veterans Way and Newhope so.
 38
 39

40 **CHAIR BARNES** – Okay, Brian.
 41

42 **COMMISSIONER LOWELL** – I'd like to wish everyone a Happy Halloween.
 43 Halloween is Tuesday. If you're not here at City Council Chambers, make sure
 44 you're out trick-or-treating and, if you are, be safe. Wear something light colored.
 45 My kids will be out there. They look forward to it every year, so Happy
 46 Halloween everybody.

1
2
3
4
5
6
7
8
9
10
11
12
13
14
15
16
17
18
19
20
21
22
23
24
25
26
27
28
29
30
31
32
33
34
35
36
37
38
39

CHAIR BARNES – Thanks, Commissioner Lowell. Alright, we are officially adjourned until November 9, 2017, here in these chambers. Thanks everyone.

NEXT MEETING

Next Meeting: Planning Commission Regular Meeting, November 9, 2017 at 7:00 PM, City of Moreno Valley, City Hall Council Chamber, 14177 Frederick Street, Moreno Valley, CA 92553.

Richard J. Sandzimier
Planning Official
Approved

Date

Jeffrey Barnes
Chair

Date

Attachment: Planning Commission Hearing Minutes 10.26.17 (2866 : A CITYWIDE MUNICIPAL CODE (TITLE 9) AMENDMENT ADDRESSING

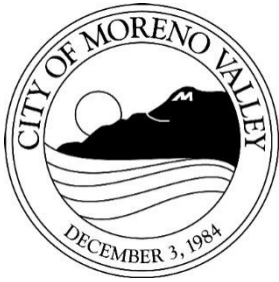

**NOTICE
OF
CITY COUNCIL PUBLIC HEARING**

THE CITY COUNCIL WILL CONSIDER A CITYWIDE MUNICIPAL CODE AMENDMENT TO THE ACCESSORY DWELLING UNIT (ADU) REGULATIONS (FORMERLY SECOND DWELLING UNITS).

The proposed project (PEN17-0115) is an amendment to the City's existing Accessory Dwelling Unit (ADU) regulations (Section 9.09.130 of the Municipal Code and other applicable sections). The proposed amendment consists of changes to the existing development standards applicable to new accessory dwelling units. The purpose of the proposed Municipal Code text amendment is to implement recently adopted State regulations, and facilitate the development of accessory dwelling units while maintaining the established character of Moreno Valley's single-family neighborhoods.

The adoption of an ordinance regarding second units in a single-family or multiple-family residential zone by a city or county to implement the provisions of Sections 65852.1 and 65852.2 of the Government Code" relating to "second unit ordinances" has been found to be exempt from the California Environmental Quality Act (CEQA) in accordance with Section 15282(h). Similarly, the ministerial approvals of ADUs would not be a "project" under CEQA (Section 15268), and environmental review would not be required prior to approving individual applications.

Any person interested in the proposal may speak at the hearing or provide written testimony at or prior to the hearing. Any person interested in the proposed project may contact Claudia Manrique, Associate Planner at (951) 413-3225 or at the Community Development Department at 14177 Frederick Street, Moreno Valley, California, during normal business hours (7:30 a.m. to 5:30 p.m., Monday through Thursday and 7:30 a.m. to 4:30 p.m., Friday), or you may telephone (951) 413-3206 for further information.

If you challenge this item in court, you may be limited to raising only those issues you or someone else raised at the Public Hearing described in this notice, or in written correspondence delivered to the City Council on or before the following meeting date:

**Tuesday, December 19, 2017
6:00 P.M.
City Council Chambers
14177 Frederick Street
Moreno Valley, CA 92552-0805**

Upon request and in compliance with the Americans with Disabilities Act of 1990, any person with a disability who requires a modification or accommodation in order to participate in a meeting should direct such request to Guy Pegan, ADA Coordinator, at 951.413.3120 at least 48 hours before the meeting. The 48-hour notification will enable the City to make reasonable arrangements to ensure accessibility to this meeting.

ORDINANCE NO.

AN ORDINANCE OF THE CITY COUNCIL OF THE CITY OF MORENO VALLEY, CALIFORNIA, APPROVING PA17-0115 AMENDING TITLE 9 OF THE CITY OF MORENO VALLEY MUNICIPAL CODE ADDRESSING ACCESSORY DWELLING UNITS (ADUs) TO ENSURE COMPLIANCE WITH NEW STATE OF CALIFORNIA LAWS

The City Council of the City of Moreno Valley does ordain as follows:

WHEREAS, it is a City-initiated work effort to update the Municipal Code to maintain consistency with state law and city practices; and

WHEREAS, the City has developed provisions in its Municipal Code for Accessory Dwelling Units in Title 9 (Planning and Zoning), Section 9.09.130 (currently entitled "Secondary Dwelling Units"); and

WHEREAS, these provisions are subject to periodic modification in response to new State laws and changes to the California Government Code; and

WHEREAS, Section 65852. 2 of the California Government Code was amended in September 2016 as a result of the passage of Senate Bill 1069 and Assembly Bill 2299; and

WHEREAS, cities and counties across the State of California are expected to revise their Accessory Dwelling Unit regulations by or after January 1, 2017 to implement the new requirements, and submit their revised regulations to the California Department of Housing and Community Development within 60 days after they become effective; and

WHEREAS, the amendments to Title 9 (Planning and Zoning), Section 9.09.130 would meet all requirements of the revised Government Code and are consistent with the new State guidelines for Accessory Dwelling Unit regulations published by the California Department of Housing and Community Development in December 2016; and

WHEREAS, amendments to the other sections of the Moreno Valley Municipal Code which may be contained within this Amendment are intended to ensure internal consistency throughout the Code; and

WHEREAS, on October 15, 2017, a 1/8 page Public Notice was published in the *Press Enterprise Newspaper*, advertising a duly noticed public hearing before the Planning Commission regarding the proposed code amendments related to Accessory Dwelling Units (ADUs); and

1
Ordinance No.
Date Adopted:

WHEREAS, on October 26, 2017, the Planning Commission reviewed the proposed code amendments, and discussed the proposed amendments in the context of the public hearing; and

WHEREAS, after full deliberation on the matter, on October 26, 2017, the Planning Commission adopted Planning Commission Resolution No. 2017-33, thereby recommending to the City Council the adoption of an ordinance to amend Title 9 (Planning and Zoning) of the City Municipal Code; and

WHEREAS, the amendment of the Moreno Valley Municipal Code is exempt from further environmental review pursuant to Section 15282(h) of the California Environmental Quality Act (CEQA) Guidelines; and

WHEREAS, on December 8, 2017, a 1/8 page Public Notice was published in the *Press Enterprise Newspaper*, advertising a duly noticed public hearing before the City Council regarding proposed code amendments related to Accessory Dwelling Units (ADUs); and

WHEREAS, the City Council of the City of Moreno Valley has considered information presented by the Community Development Director, the Planning Commission and other interested parties at a public hearing held on December 19, 2017; and

WHEREAS, the City Council has determined that the adoption of this Ordinance is in the best interests of the City.

NOW THEREFORE, THE CITY COUNCIL OF THE CITY OF MORENO VALLEY DOES ORDAIN AS FOLLOWS:

SECTION 1. CEQA.

Pursuant to Section 21083 of the California Environmental Quality Act (CEQA) statutes and Section 15282(h) of the CEQA Guidelines, it has been determined that this amendment of the Municipal Code is exempt from further environmental review.

SECTION 2. Severability.

If any portion of this Ordinance, or application of any such provision to any person or circumstances, shall be held invalid, the reminder of this Ordinance to the extent it can be given effect, or the application of such provisions to persons or circumstances other than those as to which it is held invalid, shall not be affected thereby, and to this extent the provisions of this Ordinance are severable.

SECTION 3. Amendment of Zoning Code.

2
Ordinance No.
Date Adopted:

Amendments of Title 9 (Planning and Zoning) of the Moreno Valley Municipal Code are in the best interest of the public because the revisions will ensure the Municipal Code maintains consistency with state law and city practices. Section 9.09.130, Accessory Dwelling Unit (ADU), Section 9.11.040, Off-Street Parking Requirements and Section 9.15, Definitions of the Moreno Valley Municipal Code are hereby amended, as shown in the attached Exhibits A and B, and incorporated herein by reference.

SECTION 4. Findings.

Based on the entirety of the record, the City Council hereby finds that the Municipal Code amendments, as shown in the attached Exhibits A and B, and incorporated herein by reference, are consistent with the 2006 General Plan adopted in October, 2006. The City Council further finds that consideration of the proposed amendments complies with the notice and hearing provisions of the Municipal Code.

SECTION 5. MUNICIPAL CODE AMENDED SECTION 9.09.130:

5.1 Section 9.09.130, Accessory Dwelling Unit (ADU), of Chapter 9.09 of Title 9 of the City of Moreno Valley Municipal Code is hereby amended and replaced with the text provided in Exhibit A of this Ordinance.

SECTION 6. MUNICIPAL CODE AMENDED SECTION 9.11.040:

6.1 Table 9.11.040A-12 (Off-Street Parking Requirements) within Section 9.11.040, Off-Street Parking Requirements of Chapter 9.11 of Title 9 of the City of Moreno Valley Municipal Code is hereby amended and replaced with the text provided in Exhibit B of this Ordinance.

SECTION 7. MUNICIPAL CODE AMENDED SECTION 9.15.030:

7.1 Section 9.15.030 of Chapter 9.15 of the City of Moreno Valley Municipal Code is hereby amended by adding two new definitions: accessory dwelling unit and efficiency unit. All other definitions in Section 9.15.030 remain unchanged.

7.2 Section 9.15.030 of Chapter 9.15 of the City of Moreno Valley Municipal Code is hereby amended to add the following two definitions, inserted within the chapter in applicable alphabetical order:

“Accessory dwelling unit” means an attached or a detached residential dwelling unit, which provides complete independent living facilities for one or more persons. It shall include permanent provisions for living, sleeping, eating, cooking, and sanitation on the same parcel that the existing single-family dwelling is situated.

“Efficiency unit” means an attached unit for occupancy by no more than two persons which have a minimum floor area of 150 square feet and which may also

3

Ordinance No.
Date Adopted:

have partial kitchen or bathroom facilities, as allowed in Section 17958.1 of the Health and Safety Code.

SECTION 8. EFFECT OF ENACTMENT

Except as specifically provided herein, nothing contained in this ordinance shall be deemed to modify or supersede any prior enactment of the City Council which addresses the same subject addressed herein.

SECTION 9. NOTICE OF ADOPTION

Within fifteen days after the date of adoption hereof, the City Clerk shall certify to the adoption of this ordinance and cause it to be posted in three public places within the city.

SECTION 10. EFFECTIVE DATE

This ordinance shall take effect thirty (30) days after the date of adoption.

INTRODUCED at a regular meeting of the City Council on December 19, 2017 and PASSED, APPROVED, and ADOPTED by the City Council on ____ the following roll call vote, to wit:

- AYES: Council Members -
- NOES: Council Members -
- ABSENT: Council Members -
- ABSTAIN: Council Members -

ATTEST:

Mayor

Pat Jacquez-Nares, CMC & CERA, City Clerk

APPROVED AS TO FORM:

Martin D. Koczanowicz, City Attorney

4
Ordinance No.
Date Adopted:

ORDINANCE JURAT

STATE OF CALIFORNIA)
COUNTY OF RIVERSIDE) ss.
CITY OF MORENO VALLEY)

I, Pat Jacquez-Nares, City Clerk of the City of Moreno Valley, California, do hereby certify that Ordinance No. YYYY-____ was duly and regularly adopted by the City Council of the City of Moreno Valley at a regular meeting thereof held on the ____ day of _____, YYYY, by the following vote:

AYES:

NOES:

ABSENT:

ABSTAIN:

(Council Members, Mayor Pro Tem and Mayor)

CITY CLERK

(SEAL)

Exhibit A

9.09.130 Accessory Dwelling Units (ADU).

A. Purpose and Intent. The purpose of these standards is to ensure:

1. Accessory dwelling units (ADU) as defined herein are a permitted accessory use. This chapter establishes location and development standards for the construction and occupancy of accessory dwelling units on single-family residential lots. The standards herein serve to ensure accessory dwelling units are constructed in a manner that is consistent with the requirements and allowances of state law.

2. An accessory dwelling unit does not exceed the allowable density for a lot upon which an ADU is built. ADUs are a residential use that is consistent with the existing general plan and zoning designation.

B. Applicability. Each accessory dwelling unit (ADU) shall require approval of an administrative plot plan, and shall comply with the development standards for the district in which it is located and the provisions of this section.

C. Definitions.

For the purpose of this chapter, the following definitions shall apply unless the context clearly indicates or requires a different meaning.

1. "Accessory dwelling unit" means an attached or a detached residential dwelling unit, which provides complete independent living facilities for one or more persons. It shall include permanent provisions for living, sleeping, eating, cooking, and sanitation on the same parcel the existing single-family dwelling is situated.

2. "Efficiency unit" means a unit for occupancy by no more than two persons which have a minimum floor area of one-hundred fifty (150) square feet and which may also have partial kitchen or bathroom facilities, as allowed in Section 17958.1 of the Health and Safety Code.

D. Approval Authority.

Approval of an accessory dwelling unit is considered a ministerial action and the approval authority is the Community Development Director. Approval of an accessory dwelling unit is subject to all applicable requirements established within this chapter as well as all building, fire, engineering, flood, water quality, environmental codes, standards, and permitting fees established by the City.

E. Application and Processing.

1. ADU proposed within previously permitted existing space: Applications for an accessory dwelling unit to be established within an existing permitted space including,

the primary structure, an attached or detached garage or other accessory structure on the same property shall be made to the Community Development Department and shall be permitted ministerially with approval of both an Administrative Plot Plan and a building permit where all of the following have been submitted to the satisfaction of the Community Development Director:

- a. A detailed description and scaled, dimensioned floor plan of the proposed ADU, clearly illustrating the bedroom(s), bathroom(s), kitchen and other features or other proposed habitable areas;
- b. A detailed description and scaled, dimensioned elevation of the proposed ADU, clearly illustrating the exterior entrance of the ADU;
- c. A scaled, dimensioned site plan of the property clearly illustrating the location of all improvements on site (existing primary residence, garage, driveway(s), fences/walls, accessory structures, public right-of-way improvements, etc.) and where the ADU shall be located;
- d. The scaled, dimensioned site plan of the property shall note the use(s) of all buildings existing on site.

2. New ADU: Applications for an ADU not located within an existing permitted structure or dwelling shall be made to the Community Development Department and shall be permitted ministerially with approval of both an Administrative Plot Plan and building permit where all of the following have been submitted to the satisfaction of the Community Development Director:

- a. A detailed description and scaled, dimensioned floor plan of the proposed ADU, clearly illustrating the bedroom(s), bathroom(s), kitchen and other features or other proposed habitable areas;
- b. A detailed description and scaled, dimensioned elevation of the proposed ADU, clearly illustrating the exterior of the ADU;
- c. A scaled, dimensioned site plan of the property clearly illustrating the location of all improvements on site (existing primary residence, garage, driveway(s), fences/walls, accessory structures, public right-of-way improvements, etc.) and where the ADU shall be located;
- d. The scaled, dimensioned site plan of the property shall note the use(s) of all buildings existing on site.

3. Applications shall be permitted ministerially within 120 days of application if all applicable requirements and development standards of this chapter are met and no variances are required.

F. Development Standards and Requirements.

Accessory dwelling units shall comply with the following development standards:

1. The lot is zoned for single-family or multifamily use and contains an existing, single-family dwelling.
2. Only one ADU is allowed per lot/parcel.

3. The ADU must be on the same lot as the existing dwelling.
4. The ADU shall not be for sale separate from the primary residential dwelling on site, unless the land containing the accessory dwelling unit (ADU) is first divided from the property containing the main unit in accordance with the city's subdivision regulations.
5. The applicant shall be the owner-occupant of the property and shall reside in either the primary residence or the ADU.
6. The minimum lot size for a parcel to be eligible for a detached accessory dwelling unit (ADU) shall be seven thousand two hundred (7,200) square feet. There is no minimum lot area required for an attached ADU.
7. Total lot coverage, including the ADU, shall be as permitted within the underlying zoning district. If no lot coverage is specified, the maximum lot coverage allowed is 50%.
8. The minimum square footage of a detached ADU shall be four hundred fifty (450) square feet. The unit shall include permanent provisions for living, sleeping, eating, cooking, and sanitation.
9. The maximum square footage of the ADU shall be no greater than one thousand two hundred (1,200) square feet, except when the primary dwelling unit is one thousand two hundred fifty (1,200) square feet or smaller. In that case, the ADU may exceed one thousand two hundred fifty (1,200) square feet subject to the development standards for the zoning district.
10. ADUs shall follow the development standards of the zone in which a lot is located, including but not limited to height, lot coverage, and setbacks.
11. Setbacks are not required for an existing garage that is converted to an ADU. An ADU that is constructed above a garage requires a five foot setback from the side and rear lot lines.
12. ADUs shall be located at the rear or the side of the existing single family dwelling unless it is demonstrated to the satisfaction of the Community Development Director that the ADU can only be located in front of the single family dwelling due to extraordinary or physical constraints of the lot.
13. The entrance to an attached ADU shall be separate from the entrance to the primary dwelling unit and shall be located/designed in a manner as to eliminate an obvious indication of two units in the same structure.
14. Plans that demonstrate an unobstructed pathway extending from a street to one entrance of the ADU are desirable prior to approval of an ADU application; however, is not a mandatory requirement for an ADU.

15. The unit shall have adequate water supply and sewage disposal capability.
16. ADUs, when converted from existing accessory structures, are permitted without additional restrictions provided the structure has independent exterior access and side and rear setbacks sufficient for fire safety.
17. ADUs shall be subject to all development fees specified by city ordinances or resolutions for ADUs.
18. Parking Requirements, consistent with Chapter 9.11 of this title:
 - a. One parking space is required per bedroom of an Accessory Dwelling Unit and may be provided through tandem parking.
 - b. Parking is allowed in rear and side setback areas. No parking is allowed in front setback areas.
 - c. When a garage or covered parking structure is demolished in conjunction with the construction of an Accessory Dwelling Unit, the replacement parking spaces may be located in any configuration on the same lot as the Accessory Dwelling Unit, including but not limited to covered spaces, uncovered spaces, or tandem spaces. However, replacement parking will not be a mandatory requirement.
19. Parking Exemptions. Additional parking spaces are not required for Accessory Dwelling Units in any of the following instances:
 - a. The ADU is located within one-half mile of a public transportation stop along a prescribed route according to a fixed schedule; or
 - b. The ADU is located within one block of a car share parking spot; or
 - c. The ADU is located in a historic district listed in or formally determined eligible for listing in the National Register of Historic Places and the California Register of Historical Resources or as a City Historic Preservation Overlay Zone; or
 - d. When on-street parking permits are required but not offered to the occupant of the Accessory Dwelling Unit; or
 - e. The Accessory Dwelling Unit is part of the existing Dwelling Unit or an existing accessory structure.
20. New detached or attached ADUs shall be compatible with the architectural style of the primary residence in design features. To determine architectural compatibility, the ADU must possess at least three of the following design elements in common with the primary building on the site:
 - a. Wall covering materials (wood, stucco, metal);
 - b. Wall texture (smooth, stucco, lace stucco, lap siding);
 - c. Roofing material (tile, shake, composition, metal);
 - d. Roof pitch;
 - e. Structural eaves;

- f. Mass and scale of structure relative to structural height;
- g. Window characteristics (few or numerous, single pane, multi-pane, decorative); and
- h. Decorative treatments (pop-outs, columns, dormers, window surrounds, decorative arches)

21. Outside stairways serving ADUs should not be located on any building elevation facing a public street; and when unavoidable, the design of the stairway shall mute/mitigate any potential negative aesthetic impact and maintain the character of the existing single family residence.

22. The property owner(s) shall enter into a written agreement with the city, in which the owner(s) agree to use the premises in compliance with the requirements of this section, any applicable enactments of the city council, and in form acceptable to the city attorney and the community development director. The written agreement shall include that any lease executed on an ADU shall automatically become a month to month tenancy at the time of sale or transfer of the property. Recordation of such agreement in the files of the county recorder shall be completed prior to issuance of a building permit for the ADU.

Exhibit B

**Table 9.11.040A-12
Off-Street Parking Requirements**

| Use | Requirement | Covered Parking | Notes |
|--|--|--|--|
| Residential Uses | | | |
| Single-family | 2/unit | Within an enclosed garage | |
| Accessory Dwelling Unit | 1/bedroom | | The Accessory Dwelling Unit shall provide a minimum of one parking space per bedroom in addition to the parking required for the main dwelling, except as exempted by State law (refer to 9.09.130 Accessory dwelling units). Spaces may be provided as uncovered and/or tandem parking on a driveway. |
| Duplex | 2/unit | Within an enclosed garage | |
| 3 or more units: | | | Guest parking is required for all units at "0.25 spaces/unit". Guest parking is included in the minimum required parking standard. |
| Studio | 1.25/unit | 1 covered/unit | |
| 1 bedroom | 1.5/unit | 1 covered/unit | |
| 2 bedrooms | 2.0/unit | 1 covered/unit | |
| 3+ bedrooms | 2.5/unit | 2 covered/unit | |
| Senior housing: | 1.0/unit | 1 covered/unit | Guest parking is required for all units at "0.25 spaces/unit". Guest parking is included in the minimum required parking standard. Alternate parking requirements may be permitted subject to approval of a parking study pursuant to Section 9.11.070(A) of this chapter. |
| Studio | 1.25/unit | 1 covered/unit | |
| 1 bedroom | 1.5/unit | 1 covered/unit | |
| + bedrooms | | | |
| Mobile home parks | 2.5/unit | | Tandem spaces may be used to meet resident parking requirements. |
| Residential care homes | Parking requirements shall be determined by the community development director subject to an approved parking study. | | |
| Live-work units (residential component) | 2/unit | 2 covered/unit | Guest parking is required for all units at "0.25 spaces/unit". Guest parking is NOT included in the minimum required parking standard and can be shared with the business aspect of the "live-work" parking standard. |
| Residential component of mixed-use project | See multiple-family requirements in this table | See multiple-family requirements in this table | Guest parking is required for all units at "0.25 spaces/unit". Guest parking is included in the minimum required parking standard and may be shared with the nonresidential component. Alternate parking requirements may be |

| | | |
|--|--|---|
| | | permitted subject to approval of a parking study pursuant to Section 9.11.070(A) of this chapter. |
|--|--|---|

**Table 9.11.040B-12
Off-Street Parking Requirements**

| Commercial Uses | Requirement | Notes |
|---|--|---|
| General retail (unless specified elsewhere) | 1/225 sq. ft. of gross floor area | |
| Automobile, boat, mobile home, or trailer sales, retail nurseries, or other similar outdoor commercial activities | 1/2,000 sq. ft. of display area | 1. Display area shall include all office, service and repair, or other related activities and areas that are accessible to the public. 2. No required off-street parking spaces shall be used for display, sales, service or repair of vehicles. |
| Automobile service stations, repair and service facilities | 2 spaces + 4/service bay for 4 or less bays and 2/service bay for 5 or more bays | Any related retail activities shall be subject to the general retail parking standards (mini-markets, tire sales, and the like). |
| Automobile washing and waxing establishments: Self-serve Automated | 2 spaces + 2/washing stall 10 + 1 per 2 employees | |
| Business and professional offices | 1/250 sq. ft. of gross floor area | |
| Banks, savings and loans and medical/dental offices | 1/225 sq. ft. of gross floor area | |
| Day care center | 1/employee + 1/500 sq. ft. of gross floor area | Special design requirements shall apply for bus loading or parent drop-off points. |
| Eating and drinking establishments | 1/100 sq. ft. of gross floor area up to 6,000 sq. ft. 1/75 sq. ft. of gross floor area over 6,000 sq. ft. | A minimum of 10 spaces required for stand-alone use. No additional parking required if outdoor dining area comprises no more than 15% of the interior gross floor area of the primary food service use; if outdoor dining area is over 15%, 1 space for every 60 sq. ft. or 1 space for every 3 seats, whichever is greater. |
| Eating and drinking establishments within shopping centers of 25,000 sq. ft. of building area or greater. | 1/225 sq. ft. of gross floor area up to 15% of the shopping center gross building square footage. | |
| Hotel/Motel | 1/guest room | For facilities with 100+ parking spaces, two 12'x36' through stalls for RV parking are required. These stalls may be counted as 4 auto parking stalls. |
| Kennels | 2 spaces per 1,000 sq. ft. | 2 spaces "per 1,000 sq.ft." of indoor animal enclosure. |
| Veterinary Hospital and Clinic | 1/200 sq.ft. of gross floor area | |
| Mortuaries | ¼ seats + funeral procession queue capacity for 5 cars | |
| Nail Salons | 1 space for every 2 work stations | |

| | | |
|---|--|------------------|
| Schools, private: | | |
| Business and Trade | 10 spaces + 24/classroom | |
| College | 10 spaces + 30/classroom | |
| Elementary/Junior High | 10 spaces + 2/classroom | |
| Senior High | 10 spaces + 10/classroom | |
| Storage Lots and Mini-Warehouses | 1/100 storage spaces and 2/caretaker residence | 2 spaces minimum |
| Medical and Health Services: | | |
| Convalescent and Nursing Homes | 1/3 beds | |
| Homeless Shelter | 1/4 beds | |
| Hospitals | 1/ bed | |
| Residential Care Facilities | (see Residential Uses, Section 9.11.040 Table 9.11.040A 12 | |
| Recreation: | | |
| Arcades | 1/75 sq.ft. of gross floor area | |
| Bowling and Billiards | 5/alley + 2/billiard table | |
| Commercial Stables | 1/5 horse capacity for boarding onsite | |
| Golf Course | 6/hole | |
| Golf Driving Range | 1/tee | |
| Golf, miniature | 3/hole | |
| Health Club | 1/100 sq.ft. of gross floor area | |
| Parks-Public and Private | To be determined by the approval authority based upon an approved parking study. | |
| Skating Rink | 1/100 sq.ft. of gross floor area | |
| Tennis, Handball and Racquetball facilities | 3/court | |
| Theaters | 1/3 fixed seats | |

**Table 9.11.040C-12
Off-Street Parking Requirements**

| Use | Requirement | Notes |
|----------------------------|--|---|
| Industrial Uses | | |
| Manufacturing | 1/500 sq. ft. of gross floor area | Trailer parking: parking stalls for trailers shall be provided at a ratio of 1 stall per truck loading dock door. This is in addition to the loading parking stall already provided at the dock door. |
| Research and development | 1/350 sq. ft. of gross floor area | |
| Warehouse and distribution | 1/1,000 sq. ft. of gross floor area for the first 20,000 sq. ft.; 1/ea. 2,000 sq. ft. of gross floor area for the second 20,000 sq. ft.; 1/ea. 4,000 sq. ft. of gross floor area for areas in excess of the initial 40,000 sq. ft. | |

**Table 9.11.040D-12
Off-Street Parking Requirements**

| Use | Requirement | Notes |
|---|---|--|
| Public and Quasi-Public Uses | | |
| Libraries, museums and galleries | 1/300 sq. ft. of gross floor area | |
| Public utility facilities without an office on-site | 2/employee on the largest shift + 1/company vehicle | A minimum of 2 spaces shall be required. |
| Auditorium, places of public assembly and places of worship | 1/3 fixed seats or 1/35 sq. ft. of gross floor area of the assembly area or 1 space for every 4.5 lineal feet of benches/pews, whichever is greater | |
| Government offices | To be determined by a parking study approved by the community development director | |



Report to City Council

TO: Mayor and City Council

FROM: Marshall Eyerman, Chief Financial Officer

AGENDA DATE: December 19, 2017

TITLE: PUBLIC HEARING FOR THE FIVE YEAR CONSOLIDATED PLAN FOR PROGRAM YEARS 2018/2019 - 2022/2023 AND THE ANNUAL ACTION PLAN FOR PROGRAM YEAR 2018-2019 & TO ADOPT PROGRAM YEAR 2018-2019 OBJECTIVES AND POLICIES.

RECOMMENDED ACTION

Recommendations: That the City Council:

1. Conduct a Public Hearing to allow for the public to comment on the needs of low-and-moderate income residents in Moreno Valley.
2. Approve the proposed CDBG, HOME, and ESG Grant Objectives and Policies for the 2018-2019 Program Year.

SUMMARY

Every year, the Department of Housing and Urban Development (HUD) allocates federal grant monies to the City of Moreno Valley known as the Community Development Block Grant (CDBG), Emergency Solutions Grant (ESG), and the HOME Investment Partnership Program (HOME). These grants are used to provide services to benefit low-and-moderate income persons. (See Attachment 1 for the most recent income levels). Eligible CDBG activities range from social services to capital improvements to business and employment development. HOME funds must be used toward the development of affordable housing programs. ESG funds are focused on services to homelessness prevention. HUD requires that cities concentrate their programs in areas determined to contain residents of which at least 51% earn low-to-moderate incomes. These areas are referred to as 'CDBG Target Areas'. (See Attachment 2 for a map of Moreno Valley's CDBG Target Areas.)

As a condition for receiving Federal funding under the CDBG, ESG, and HOME

Programs, grantee cities must prepare a Consolidated Plan and an Annual Action Plan. The City will conduct two public hearings and a 30-day comment period to allow for public input in the development of these documents. The City Council is asked to open the PUBLIC HEARING to discuss and adopt Objectives/Policies and Collect Community Needs Comments. The Plan will address housing, homeless, community development and economic development needs to be undertaken with federal funds under the CDBG, ESG and HOME programs.

The Notice of Funding Availability (NOFA) and application process for the potential sub recipients of any grant funds distributed by the City will occur on December 20. The potential award of any grant funds will occur following the review of applications and future City Council public meetings.

DISCUSSION

Five Year Consolidated Plan (FY 2018/2019 – FY 2022/2023)

The Consolidated Plan identifies the housing and community development needs of the City's low-and-moderate income community, as defined by HUD, and establishes the City's HUD-funded strategies for addressing these needs for a five-year period. It serves as the official application to HUD for the CDBG, ESG and HOME Programs. Moreno Valley's existing Consolidated Plan was adopted in Fiscal Year (FY) 2013/2014 and will remain in effect until June 30, 2018. The next Consolidated Plan will cover the five-year period from July 1, 2018 through June 30, 2023.

Needs Assessment

In addition to extensive research performed, participation by community members is crucial in recognizing the most pressing housing and community development needs in the region. To solicit public input during the Consolidated Plan development two public hearings, and a 30-day comment period will be held.

Citizen input will be included in the public engagement section of the Consolidated Plan and will be used to help develop housing and community development needs, which will be summarized in the Needs Assessment section of the Consolidated Plan. Needs which have been determined to be a High Priority level may receive funding during the FY 2018/2019 - FY 2022/2023 Consolidated Plan period. Needs with a Low Priority may be funded based on the availability of funds.

Based on the purposes and goals of the HUD programs, the City intends to use the grant funds to coordinate programs, services, and projects to create a decent and suitable living environment to benefit low- and moderate-income households and those with special needs.

The priorities for each category in the FY 2013/2014 – FY 2017/2018 Consolidated Plan are listed below:

- CDBG Public Service Funding Priorities
 1. Basic Needs Related to Social Services Programs (such as but not limited to emergency food, shelter (homelessness), and utility assistance)
 2. Community Public Safety Programs
 3. Programs Offering Low-Cost Transportation
 4. Employment Services/Programs and Job Skills Training
 5. Free/Low-Cost Programs for School-Aged Youth
 6. Fair Housing
- CDBG Housing and Community Development Funding Priorities
 1. Capital Improvement Activities
 2. Economic Development Activities
 3. Health, Safety and Public Welfare
 4. Housing and Neighborhood Improvement Activities³
 5. Historic Preservation
 6. Slum or Blight Activities
- HOME Investment Partnership Program (HOME) Funding Priorities
 1. Housing and Neighborhood Improvement Activities
- Emergency Solutions Grant (ESG) Funding Priorities
 1. Homeless/Homeless Prevention Activities

Strategic Plan

As part of the Consolidated Plan, a Strategic Plan will be developed that describes the following: general priorities for assisting households; programs to assist those households in need; and five-year objectives identifying proposed accomplishments. The Strategic Plan also addresses anti-poverty strategy; lead-based paint hazard reduction; reduction of barriers to affordable housing; and institutional processes/structure and coordination among agencies.

Annual Action Plan (FY 2018/2019)

For each Consolidated Plan year, entitlement cities must adopt a separate planning document called the Annual Action Plan. The Annual Action Plan identifies how the City will allocate CDBG, ESG and HOME funds for the upcoming year while meeting the goals established in the Consolidated Plan. Each Annual Action Plan must include up-to-date Objectives and Policies for CDBG, ESG and HOME Programs.

Prior to submittal of the FY 2018-2019 Annual Action Plan, the City will complete a series of sequential activities including three Public Hearings to:

1. Adopt current Objectives and Policies,
2. Recommend CDBG, ESG and HOME Project Selections to Council,

- and
3. Adopt the program year Annual Action Plan.

An eligible use of CDBG monies is 'Public Services'. Public Services can include but not limited to food banks, homeless shelters, specialized counseling, foster youth services, etc. that benefit the City's low-income households. HUD limits the monies that can be used toward Public Services up to 15% of the overall annual CDBG allocation, which for Moreno Valley averages approximately \$1,900,000 per year. Because these particular monies are very limited and the demand is so high, the City Council has previously established a priority ranking within this objective category that assists in reaching decisions on which programs are best suited for the community within a given year.

After comprehensive research, including consideration of public input and review of various program reports, including those provided by the City's local non-profits currently serving the City's low-and-moderate income population, staff recommends maintaining the current priority ranking under the Public Service Objective:

1. Basic Needs Related Social Services Programs (such as but not limited to emergency food, shelter (homelessness), and utility assistance)
2. Community Public Safety Programs
3. Programs Offering Low-Cost Transportation
4. Employment Services/Programs and Job Skills Training
5. Free/Low-Cost Programs for School-Aged Youth
6. Fair Housing

Public Engagement

Citizen participation is one of the most important components of the Consolidated Plan and Annual Action Plan process. To solicit public input during the development of the plans, two public hearings and a 30-day comment period will be administered. Before the City can begin the project selection process for CDBG, ESG, and HOME, HUD requires the City to complete a mandatory 'Citizen Participation Process' and adopt objectives and policies that reflect the current needs of the community.

Moreno Valley's 'Citizen Participation Process'

The 'Citizen Participation Process' is intended to encourage active and informed participation in the CDBG, ESG, and HOME Programs by the community. Each year as part of this process, Moreno Valley holds community-based meetings and Public Hearings to receive input on the current needs of its low-to-moderate income residents. Attendees are asked to comment on issues and problems affecting low-to-moderate income persons so that the City make informed funding decisions.

Comments received at these meetings are taken into consideration when forming the Objectives and Policies for the program year.

In preparation of the Five-Year Consolidated Plan (Program Periods 2018/2019 – 2022/2023) and the Annual Action Plan (Program Year 2018/2019) and as part of the City's Citizens Participation process, the City is required to complete a series of activities to promote the public and community participation. The preliminary schedule below identifies the key activities, Public Meetings and Public Hearings in line with the City's Citizen Participation process.

| Preliminary Dates | Event |
|------------------------------|--|
| Tuesday, November 28, 2017 | Public Meeting 1: Public Meeting to Review Action Plan/Consolidated Plan Calendar Schedule |
| Tuesday, December 19, 2017 | Public Hearing 1: Public Hearing to Adopt Objectives/Policies & Collect Community Needs Comments |
| Wednesday, December 20, 2017 | Notice of Funding Availability (NOFA) Available. APPLICATIONS AVAILABLE FOR DISTRIBUTION. |
| Thursday, January 11, 2018 | In-Person Application Workshop |
| Wednesday, January 31, 2018 | Applications Due from Applicants |
| March 7-11, 2018 | Finance Subcommittee 1:1 Meetings to Review Staff Project Recommendations |
| Tuesday, March 27, 2018 | Public Meeting 2: Open Technical Review Committee Meeting - Applicants are invited to attend and provided with an opportunity to explain programs in person. |
| Friday, March 30, 2018 | Commencement of 30 - Day Action Plan & Con Plan Public Comment/Review Period |
| Tuesday, April 17, 2018 | Public Hearing 2 for Action Plan: Public Hearing to Review Project Recommendations as issued by the Finance Subcommittee |
| Tuesday, May 01, 2018 | Public Hearing 2 for Con. Plan and Public Hearing 3 for Action Plan: Approve Con Plan and Annual Action Plan |
| Tuesday, May 15, 2018 | Submittal of Con. Plan and 2018-19 Action Plan to HUD |

Purpose of Objectives and Policies

In accordance with HUD's requirements, Moreno Valley's Objectives and Policies must be re-evaluated each year to ensure they adequately reflect the current needs of the community. The updated Objectives and Policies must then be adopted by the City Council for the upcoming CDBG, ESG, and HOME program year. Objectives and Policies primarily focus on: (1) defining the City's funding priorities, (2) offering project selection criteria, and (3) providing guidance for staff when reviewing and recommending programs and projects for funding. These program funds are distributed to non-profit agencies who are interested in applying for funding to develop a local social service program in Moreno Valley and convey important information about the eligible categories of programs and the City's priorities for local organizations.

30-Day Public Comment Period

In accordance with the City's Citizen Participation Plan, the City will release the draft FY 2018/2019 – FY 2022/2023 Five-Year Consolidated Plan and draft FY 2018 – FY 2019 Action Plan for public comment. The documents will be made available to the public for a 30-day review and comment period beginning on March 30, 2018 and ending on May 1, 2018.

ALTERNATIVES

The City Council has the following alternatives:

1. City Council may conduct a Public Hearing, receive comments, and adopt the proposed CDBG, ESG, and HOME Objectives and Policies as listed on Attachment 3. The City Council may amend or reprioritize any of the proposed Objectives and Policies. Staff recommends this alternative as doing so will meet HUD's requirements, as well as provide the public and staff with direction regarding funding proposals for FY 2018/2019.
2. City Council may choose not to adopt the proposed CDBG and HOME Objectives and Policies as listed on Attachment 3. Staff does not recommend this alternative because it would delay the necessary measures to meet HUD's established deadline for submission of these documents.

FISCAL IMPACT

The City, as an entitlement city for CDBG, ESG, and HOME funds, receives grant funds every year to carry out eligible housing and community development activities. Further, staffing costs for administering the CDBG, ESG, and HOME programs are covered by an administration cap within each program. No General Fund money is used for the CDBG or HOME programs; therefore, there is **NO FISCAL IMPACT TO THE GENERAL FUND.**

NOTIFICATION

Notice of this meeting was published in the local edition of the Press-Enterprise newspaper on November 30, 2017.

PREPARATION OF STAFF REPORT

Prepared By:
Dena Heald
Financial Operations Division Manager

Department Head Approval:
Marshall Eyerman
Chief Financial Officer / City Treasurer

CITY COUNCIL GOALS

None

CITY COUNCIL STRATEGIC PRIORITIES

- 1. Economic Development
- 2. Public Safety
- 3. Library
- 4. Infrastructure
- 5. Beautification, Community Engagement, and Quality of Life
- 6. Youth Programs

ATTACHMENTS

- 1. 2017 HUD Income Limits
- 2. CDBG Approved Target Areas- Effective 11.17.17
- 3. Policies and Objectives

APPROVALS

| | | |
|-------------------------|-------------------|------------------|
| Budget Officer Approval | <u>✓ Approved</u> | 12/01/17 8:00 AM |
| City Attorney Approval | <u>✓ Approved</u> | 12/04/17 3:19 PM |
| City Manager Approval | <u>✓ Approved</u> | 12/07/17 3:09 PM |

2017 INCOME LIMITS

Revised Annually by the Dept. of Housing & Urban Development (HUD)

| Annual Income Level | % of Area Median | Number of Persons in Household | | | | | | | |
|----------------------|------------------|--------------------------------|----------|----------|----------|----------|----------|----------|----------|
| | | 1 | 2 | 3 | 4 | 5 | 6 | 7 | 8 |
| Extremely Low Income | 30% | \$13,550 | \$16,240 | \$20,420 | \$24,600 | \$28,780 | \$32,960 | \$37,140 | \$41,320 |
| Very Low Income | 50% | \$22,600 | \$25,800 | \$29,050 | \$32,250 | \$34,850 | \$37,450 | \$40,000 | \$42,600 |
| Low Income | 80% | \$36,150 | \$41,300 | \$46,450 | \$51,600 | \$55,750 | \$59,900 | \$64,000 | \$68,150 |

CITY OF MORENO VALLEY HUD-CDBG LOW/MOD CENSUS TRACTS 2017

 Low/Mod Census Tracts and Blocks

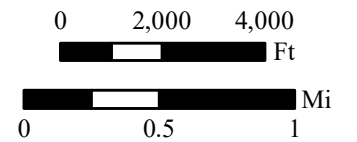

Map Produced by Moreno Valley Geographic Information System

Geographic Information in:
State Plane NAD 83 California Zone 6 Feet
T:\Divisions\Finance\2017\MXD\
CDBG_approvedtargetareas_2017_110917B.mxd
Effective: 17 November 2017

The information shown on this map was compiled from the Riverside County GIS and the City of Moreno Valley GIS. The land base and facility information on this map is for display purposes only and should not be relied upon without independent verification as to its accuracy. Riverside County and City of Moreno Valley will not be held responsible for any claim losses or damages resulting from the use of this map.



Attachment: CDBG Approved Target Areas- Effective 11.17.17 (2893 : PUBLIC HEARING FOR THE FIVE YEAR CONSOLIDATED PLAN FOR

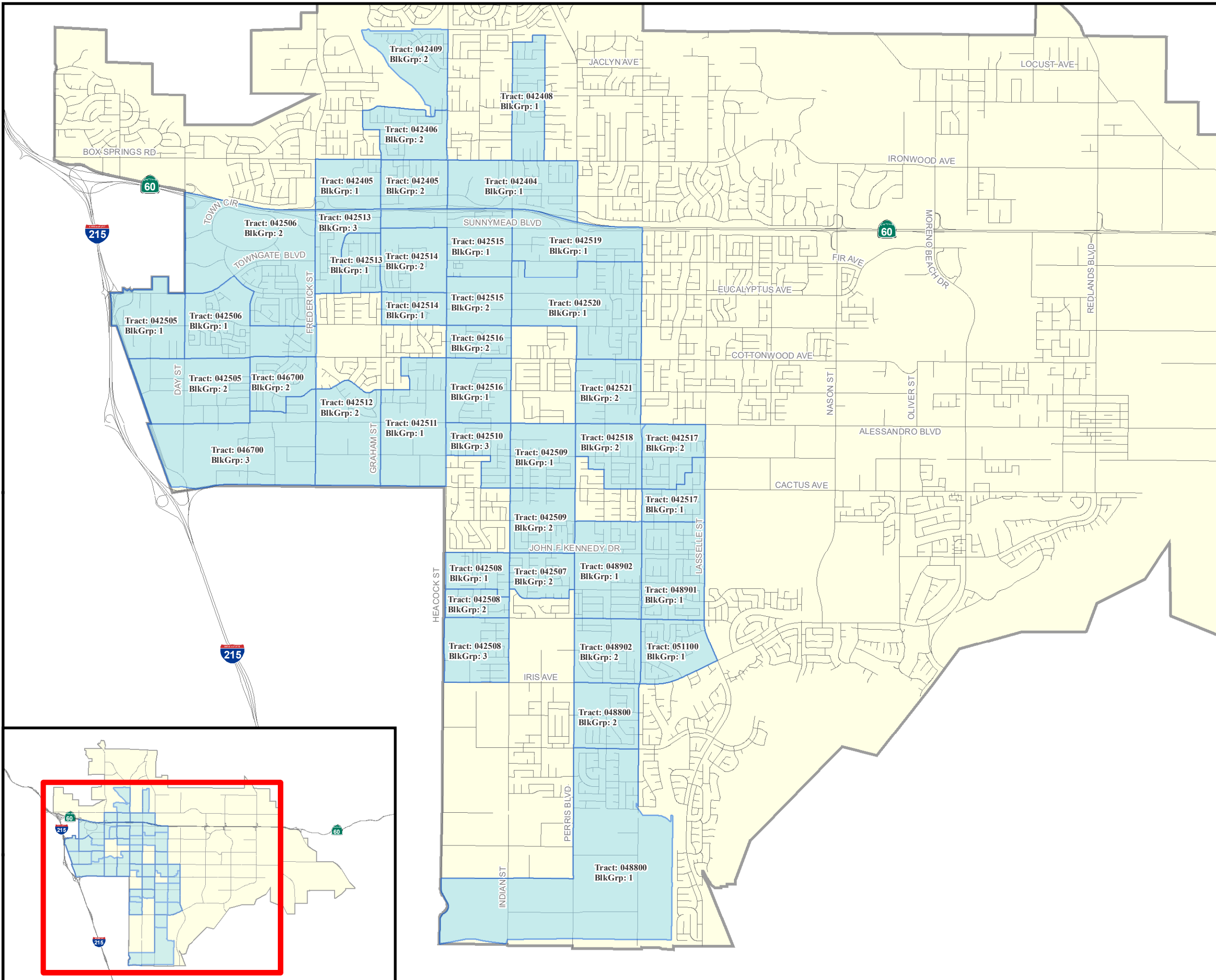

FY 2018-2019 Proposed CDBG, HOME, & ESG Objectives and Policies

The City of Moreno Valley proposes to establish the following Objectives and Policies in order to give maximum priority to projects and activities that will benefit low-to-moderate income residents. Proposed programs for the upcoming year should fit into one of the categories of Program Objectives. CDBG programs must also fit into one of the listed National Objectives. Staff will abide to the given Policies when reviewing proposed programs for potential funding.

CDBG NATIONAL OBJECTIVES

In order for an activity or program to be eligible for CDBG funding, it must qualify as meeting one or more of the following three national objectives as well as one of the general program objectives below:

- 1) Activities Benefiting Low- and Moderate-income Persons and/or Households:
A low-to-moderate income person or household is one having an income equal to or less than the Section 8 lower income limits established by HUD. This objective includes direct services to the low-to-moderate income, services benefitting a low-income area, or 'limited clientele', who are designated groups presumed by HUD to automatically qualify as low-to-moderate income.
- 2) Activities Which Aid in the Prevention or Elimination of Slums or Blight:
This objective can be achieved on a spot basis, area basis, or address blight in a designated urban renewal area.
- 3) Activities Designed to Meet Community Development Needs Having a Particular Urgency: This objective is given priority under formally declared state of emergencies and is normally used to alleviate urgent conditions caused by major catastrophes, natural disasters, or other emergencies that presents a serious and immediate threat to the health and welfare of the community.

GENERAL PROGRAM OBJECTIVES *(listed alphabetically)*

Capital Improvement Activities

Acquisition, design, construction, and installation of needed public facilities and improvements located in CDBG income eligible Target Areas where infrastructure is missing or substandard. Public facilities and improvements may include ADA-compliant ramps and sidewalk improvements, storm drains, and water and sewer lines. Improvements shall facilitate pedestrian activity, eliminate flooding, and provide for safer streets within the Target Areas.

Economic Development Activities*

Expanded economic opportunities through micro-enterprise loan programs and counseling as well as employment and job skills programs to create and retain jobs for low-and-moderate persons.

Fair Housing Activities *

The promotion of housing choice and support of state and federal fair housing laws to ensure that all residents have access to a decent home in a suitable living environment in the City. Fair Housing activities are met by promoting and affirmatively furthering equitable housing opportunities through education, counseling, enforcement, and training.

This objective also includes the prevention of foreclosure through counseling, mediation, and case management for homeowners facing mortgage delinquency, default, or any stage of foreclosure, thereby maintaining safe, stable neighborhoods and community.

Health, Safety, and Public Welfare

Eliminating conditions which are detrimental to health, safety, and public welfare through interim rehabilitation, community policing, code enforcement, etc.

Historic Preservation*

Restoring and preserving properties formally designated as historic structures.

Homeless/Homeless Prevention Activities

Improve the quality of life for the city's homeless and those threatened with homelessness by extending emergency services aimed at assisting, protecting,

and improving the living conditions and ultimately stabilizing the housing situation of those individual(s).

Housing and Neighborhood Improvement Activities

Conserving and improving housing stock through rehabilitation of units occupied by low-and-moderate income households. Activities are designed to: (1) improve existing substandard or deteriorated housing stock that does not meet building, safety, or fire code and (2) achieve the goals identified in the City's Consolidated Plan.

Public Service Activities*

Improving the quantity and quality of public services, principally for low-and-moderate income persons, including the homeless, elderly, and disabled. The following services are identified by order of priority:

- (1) 'Basic Needs' Related Social Services Programs (such as but not limited to emergency food, shelter (homelessness), and utility assistance)
- (2) Community Public Safety Programs
- (3) Programs offering Low-Cost Transportation
- (4) Employment Services/Programs and Job (Skills) Training
- (5) Free/Low-Cost programs for School-Aged Youth

Slum or Blight Activities

Elimination of slums and blight in order to prevent the deterioration of City neighborhoods, principally in the CDBG Target Areas.

**** These activities pertain to the CDBG Program only.***

POLICIES

In order to meet the objectives and ensure efficient use of CDBG, HOME, and ESG funds, the following policies have been established:

City Projects and Programs

Certain public improvements, such as storm drains, curb, gutter, and sidewalks may at the Council's discretion be given priority and that provide long term benefits to improve low-and-moderate income CDBG Target Areas. Examples of these City sponsored programs include Code Enforcement activities, Community Policing, and Neighborhood Clean-ups.

Provider Collaboration

Providers (local non-profits) that intend to provide similar services and programs to Moreno Valley's low-and-moderate residents shall be given funding priority for combining resources and efforts into a single program. Providers complete and submit a single CDBG, ESG and HOME application on behalf of the collaborating group. Funding priority would be given at the time of application review in the form of extra points on their overall application.

Local Services

Providers that are located in the City will be given funding priority when they are providing services equivalent to those offered by providers located outside the City.

The ultimate goal is to have services available and accessible within the City limits to serve all residents, especially those of low-and-moderate income. Prior to final selection of projects, other factors such as track record and experience will need to be considered.

Minimum Grant Level

A minimum grant level of \$10,000 for CDBG, \$25,000 for HOME, and \$50,000 (excluding Homelessness Management Information Systems) for ESG has been established for the purpose of ensuring the most efficient use of these funds. Priority may be given to grant requests that exceed \$15,000, subject to staffing and administrative capabilities.

Project and Program Funding

Pre-existing Projects and Programs having other funding sources will be given priority. Grant funding is intended to supplement a project or a program and not be its full funding source.

Federal funding varies from year to year as do the needs of the community. It is therefore important for a project or proposal to sustain itself should City funding not be available. Such an approach will also provide for the maximum leveraging and impact.

Minimal Applicant Requirements

In order to ensure an applicant is adequately qualified to administer an activity per the federal statutes and regulations, a set of minimal applicant requirements shall be established for inclusion in the grant application. The requirements shall be reasonable and follow HUD recommendations. It is preferred that an applicant have a minimum of three years of successful grant management experience. This may be supported by written documentation; for example, conclusive audit results letter.

Multi-Year Contracts/Agreements

For CDBG and ESG, the City shall execute a standard subrecipient agreement and offer the possibility for a one-year extension. Extensions shall be issued only in instances where funding allows, the subrecipient has successfully completed the terms and performance goals in the agreement during the initial year, and shall also be subject to City Council approval.

ESG Match Requirements

Federal regulations require a 100% match for the ESG program. The City shall require the subrecipient be responsible for the full match.

The match may be met with a combination of cash or in-kind services. In-kind matches (as defined by HUD), including in-kind volunteer hours, may not exceed 25% of the full match requirement.

Proof of 100% match is required prior to a notice to proceed and the execution of a contract with the City. Initial documentation of proof of match, including initial award letters, shall be provided with the application for evaluation. Final verifiable third party documentation providing proof of award and availability of funds shall be provided before entering into contract with the City. If proof of award cannot be provided, then any award of ESG funds will be adjusted as necessary based on available match verified.

ESG Program Costs

The City must ensure that all costs charged to ESG are allowable, allocable and reasonable for the proper performance and administration of the award. Direct and indirect project costs should be reasonable relative to the total costs of the project. An approved indirect cost rate must be provided in order to recover indirect costs.

** These activities pertain to the CDBG Program only.*



Report to City Council

TO: Mayor and City Council

FROM: Martin Koczanowicz, City Attorney

AGENDA DATE: December 19, 2017

TITLE: RESOLUTION AMENDING AGENDA POSTING REQUIREMENTS TO MATCH STATE LAW

RECOMMENDED ACTION

Recommendations: That the City Council:

1. Consider adoption of the Resolution amending Rules of Procedure Section 1.1.2.3 to set posting and delivery of the City Council meeting agenda at 72 hours.

SUMMARY

This report provides for City Council's consideration of changing the current 12-day agenda posting requirement to 3 days, thus corresponding with the requirements of the Brown Act.

DISCUSSION

Based on available information City Council's original Rules of Procedure provided for a 72 hour posting of agendas for Council meetings, which was consistent with the requirements of State law. In 2015 the Rules of Procedures were amended through Resolution 2015-70 to install the current 12-day period for posting and distribution of the agenda packet.

The attached draft resolution would, if adopted by City Council, return the posting and distribution requirements to the State law provision of 72 hours. It would amend Section 1.1.2.3 and delete Section 1.1.2.4, which currently provides for a process to add items to the agenda during that 12-day period. If the 72 hour requirement is adopted, there would be need for such provision.

ALTERNATIVES

1. Consider the Resolution and adopt as presented.
2. Provide revisions to the draft language and then adopt.
3. Do not adopt the Resolution and retain the 12-day posting period.

FISCAL IMPACT

Staff does anticipate any adverse fiscal impacts if the attached Resolution is adopted by the City Council. There may be a positive impact on staff time as the shortening of the posting period will eliminate late additions to the agenda which currently require revisions and reposting.

NOTIFICATION

Agenda was posted in compliance with the Brown Act.

PREPARATION OF STAFF REPORT

Prepared By:
Martin D. Koczanowicz
City Attorney

Department Head Approval: NA
Martin D. Koczanowicz
City Attorney

Concurred By:
Pat Jacquez-Nares
City Clerk

CITY COUNCIL GOALS

None

CITY COUNCIL STRATEGIC PRIORITIES

1. Economic Development
2. Public Safety
3. Library
4. Infrastructure
5. Beautification, Community Engagement, and Quality of Life
6. Youth Programs

ATTACHMENTS

1. Reso to update Rules of Procedure 72hour

APPROVALS

| | | |
|-------------------------|-------------------|------------------|
| Budget Officer Approval | <u>✓ Approved</u> | 12/07/17 2:40 PM |
| City Attorney Approval | <u>✓ Approved</u> | 12/06/17 1:37 PM |

City Manager Approval

✓ Approved

12/07/17 3:11 PM

RESOLUTION NO. 2017-

A RESOLUTION OF THE CITY COUNCIL OF THE CITY OF
MORENO VALLEY, CALIFORNIA, AMENDING RULES OF
PROCEDURE FOR CITY COUNCIL MEETINGS

WHEREAS, Section 2.04.040 of the City of Moreno Valley Municipal Code requires that the City Council adopt Rules of Procedure to govern the procedures and conduct of its meetings; and

WHEREAS, the City Council has previously adopted, repealed, re-adopted and amended the City of Moreno Valley City Council Rules of Procedure for City Council Meetings and Related Functions and Activities; and

WHEREAS, the Brown Act in Government Code Section 54954.2 provides for a minimum 72 hour posting period for regular meeting agendas; and

WHEREAS, City Council has determined that it is in the best interests of the City of Moreno Valley that the City Council further amend the Rules of Procedure for City Council Meetings and Related Functions and Activities to amend the agenda posting and distribution timeline from twelve (12) to three days.

NOW, THEREFORE, THE CITY COUNCIL OF THE CITY OF MORENO VALLEY, CALIFORNIA, DOES HEREBY RESOLVE AS FOLLOWS:

1. Section 1.1.2.3 of The Rules of Procedure for City Council Meetings and Related Functions and Activities is repealed in its entirety and replaced with the following:

1.1.2.3 DELIVERY AND POSTING OF THE AGENDA.

The agenda for each regular meeting of the City Council along with the reports and other documentation related thereto, shall be delivered to the Council Members and made available to the public 72 hours before the scheduled time of the meeting to which the agenda pertains. The agenda shall conform to, and be posted in accordance with, applicable requirements of the California Government Code. Agendas shall be posted at least 72 hours prior to the time scheduled for the meeting on the bulletin board outside the City Council Chambers at City Hall and at such other places within the City as the City Council has designated for posting.

2. Section **1.1.2.4 Addition of Items Following Posting of the Agenda** shall be repealed in its entirety.
3. This resolution shall become effective upon adoption by City Council.

APPROVED AND ADOPTED this 19th day of December, 2017

Dr. Yxstian Gutierrez, Mayor

ATTEST:

Pat Jacquez-Nares, City Clerk

APPROVED AS TO FORM:

Martin Koczanowicz, City Attorney

RESOLUTION JURAT

STATE OF CALIFORNIA)
COUNTY OF RIVERSIDE) ss.
CITY OF MORENO VALLEY)

I, Pat Jacquez-Nares, CMC & CERA, City Clerk of the City of Moreno Valley, California, do hereby certify that Resolution No. 2017-__ was duly and regularly adopted by the City Council of the City of Moreno Valley at a regular meeting thereof held on the 19th day of December, 2017 by the following vote:

AYES:

NOES:

ABSENT: None

ABSTAIN: None

(Council Members, Mayor Pro Tem and Mayor)

PAT JACQUEZ- NARES, CITY CLERK

(SEAL)



Report to City Council

TO: Mayor and City Council

FROM: Mel Alonzo, Parks & Community Services Director

AGENDA DATE: December 19, 2017

TITLE: CONSIDERATION OF AN ORDINANCE CREATING THE PARKS, COMMUNITY SERVICES AND TRAILS COMMITTEE AND DISSOLVING PARKS AND RECREATION COMMISSION AND RECREATIONAL TRAILS BOARD

RECOMMENDED ACTION

Recommendations: That the City Council:

1. Introduce and conduct the first reading of Ordinance _____ creating the Parks, Community Services and Trails Committee.

SUMMARY

This report recommends steps to streamline the advisory board structure pertaining to the City's parks, recreation programs and recreational trails. The proposed Parks, Community Services and Trails Committee would consolidate existing advisory functions of two advisory bodies into a single panel with advisory responsibilities covering both areas. The proposed consolidation would also generate greater efficiency in provision of staff support to multiple advisory panels which consider matters under the operational purview of the Parks and Community Services Department.

DISCUSSION

At present, in connection with this department, the City Council appoints members to four commissions/boards which carry out responsibilities as defined by the Council. Residents appointed to these bodies provide input and advice to the Council regarding matters within the purview of the Parks and Community Services Department.

Following is a list of these existing boards and commissions along with their current membership levels:

- Arts Commission - Consists of nine members (including two teen members). There are currently two vacancies on this Commission.
- Parks and Recreation Commission - Consists of nine members (including two teen members). There are currently two vacancies on this Commission.
- Recreational Trails Board - Consists of nine members. There is currently one vacancy on this Board.
- Senior Citizens' Advisory Board - Consists of nine members. There are currently two vacancies on this Board.

Board and Commission Consolidation

In recent years, the Council has expressed interest in considering new options to streamline and consolidate various advisory boards/commissions to reduce redundant reporting and duplication of staff efforts while maximizing efficiency/effectiveness of these citizen panels. The proposal outlined in this staff report is presented for the City Council's consideration.

The proposed Parks, Community Services and Trails Committee would consolidate existing functions carried out by two of the existing advisory panels:

- Parks and Recreation Commission: Advises the Council on policy matters pertaining to the administration, operation, development, improvement and maintenance of parks, recreational facilities, and parks and recreation programs within the City.
- Recreational Trails Board: Advises the Council on policy matters pertaining to single-use and multi-use recreational trails, including bicycle, jogging, and equestrian trails within or affecting the City.

Much of the Recreational Trail Board's work supported creation of the City's Master Plan of Trails, which was incorporated into the City's General Plan in 2006. Because this allowed the City to assume authority over all future trail development, the majority of key duties assigned to the Recreational Trails Board had been accomplished. Additionally, the City Council adopted Standard Plans that provide specific guidelines regarding future trail construction.

The Ordinance recommending creation of a newly-constituted Parks, Community Services and Trails Committee lists the consolidated duties of this advisory panel and repeals provisions which created the separate Parks and Recreation Commission and Recreational Trails Board. Members would be appointed via the process outlined in the Moreno Valley Municipal Code. The Committee would consist of seven adult members and two teen members. Members of the disbanded panels would be encouraged to submit applications for appointment to the new Committee along with any other qualified

applicants. In addition to the current key duties, the Parks, Community Services and Trails Committee will also assist in improving health and promoting livable communities through partnerships, policies and programs. This is a commitment made by the City via Resolution 2014-78 to work with other jurisdictions, County departments, community partners, and regional agencies to collectively advance community health and wellness.

ALTERNATIVES

1. Introduce and conduct first reading by title only of Ordinance _____ creating the Parks, Community Services and Trails Committee and schedule for second reading and adoption at the next regularly scheduled Council meeting.
2. Make no changes to the current Parks and Recreation Commission and Recreational Trails Board.
3. Provide alternate direction to staff.

FISCAL IMPACT

A newly-constituted Parks, Community Services and Trails Committee would reduce costs currently associated with providing staff support to two separate advisory panels.

NOTIFICATION

Posting of the agenda.

PREPARATION OF STAFF REPORT

Prepared By:
Mel Alonzo
Parks and Community Services Director

Department Head Approval:
Mel Alonzo
Parks and Community Services Director

CITY COUNCIL GOALS

Positive Environment. Create a positive environment for the development of Moreno Valley's future.

Community Image, Neighborhood Pride and Cleanliness. Promote a sense of community pride and foster an excellent image about our City by developing and executing programs which will result in quality development, enhanced neighborhood preservation efforts, including home rehabilitation and neighborhood restoration.

CITY COUNCIL STRATEGIC PRIORITIES

1. Economic Development
2. Public Safety
3. Library

- 4. Infrastructure
- 5. Beautification, Community Engagement, and Quality of Life
- 6. Youth Programs

Objective 1.5: Showcase Moreno Valley’s unique assets.

Objective 5.5: Promote a healthy community and lifestyle.

Objective 6.2: Improve health, wellness and fitness for Moreno Valley youth through recreation and sports programs.

ATTACHMENTS

- 1. PCST Committee Ordinance Draft (2)

APPROVALS

| | | |
|-------------------------|-------------------|------------------|
| Budget Officer Approval | <u>✓ Approved</u> | 12/07/17 4:50 PM |
| City Attorney Approval | <u>✓ Approved</u> | 12/07/17 4:20 PM |
| City Manager Approval | <u>✓ Approved</u> | 12/07/17 5:04 PM |

ORDINANCE NO. _____

AN ORDINANCE OF THE CITY COUNCIL OF THE CITY OF MORENO VALLEY, CALIFORNIA, REPEALING CHAPTERS 2.19 AND 2.24 OF THE CITY OF MORENO VALLEY MUNICIPAL CODE AND ADOPTING NEW CHAPTER 2.19 ESTABLISHING THE PARKS, COMMUNITY SERVICES AND TRAILS COMMITTEE

The City Council of the City of Moreno Valley does ordain as follows:

SECTION 1. FINDINGS.

The City Council finds that dissolving the Parks and Recreation Commission and the Recreational Trails Board and creating the Parks, Community Services and Trails Committee will consolidate the advisory functions of the two existing advisory bodies into a single panel with advisory responsibilities covering both areas. The consolidation will reduce costs and generate greater efficiency in the provision of staff support to the advisory panels that consider matters under the operational purview of the Parks and Community Services Department.

SECTION 2. PURPOSE.

The purpose of this Ordinance is to amend the Municipal Code to reflect dissolution of the Parks and Recreation Commission and the Recreational Trails Board and consolidation of the advisory functions of each panel into a newly created advisory panel: the Parks, Community Services and Trails Committee.

SECTION 3. AUTHORITY.

This Ordinance is adopted pursuant to the authority granted by Article 11, Section 7 of the Constitution of the State of California and California Government Code Section 37100. The Ordinance is not intended to be duplicative of state law, or contain provisions preempted by state legislation.

SECTION 4.

Chapter 2.19 of the Moreno Valley Municipal Code is hereby repealed in its entirety and replaced as follows:

Chapter 2.19 PARKS, COMMUNITY SERVICES AND TRAILS COMMITTEE

Section 2.19.010 Created.

There is created a Parks, Community Services and Trails Committee for the City. It shall consist of nine members, serving without compensation, and appointed in the manner and for the terms prescribed in Sections 2.04.060 and 2.06.010, respectively, of this code, except that the terms of the members first appointed to the commission shall

be set during appointment, in such manner that three terms shall expire on June 30th of each year, and except that the terms of the teenage members shall expire two years after the effective date of appointment or until high school graduation, whichever comes first. Thereafter, all terms shall be for two years and shall expire two years after the effective date of the appointment; provided, however, that the term of an appointment made to fill an unexpired term shall be for the unexpired balance of such term.

Section 2.19.020 Composition.

Insofar as practicable, the committee shall be composed of seven public members and two teenage members. In the event that an insufficient number of persons from any one of the foregoing categories is available for appointment to the committee, the city council may make such substitute appointments as it deems necessary.

Section 2.19.030 Powers and Duties.

A. The committee shall have the general power and duty to act in an advisory capacity to the city council in all matters pertaining to the administration, operation, development, improvement and maintenance of parks, recreation facilities and trails, park and recreation programs with the city, and activities and programs of and for teenagers in and around the city.

B. In addition to the foregoing general power and duty, the commission shall have the following particular advisory duties:

- 1. Determine and report to the city council the city’s needs in respect to parks, community services and trails within the city;
- 2. Consider and advise, upon referral by the city council, the planning commission, or city staff, on acquisition and use of lands for parks, trails and other recreational purposes;
- 3. Study, consider and recommend to the city council long-range plans for ultimate development of city parks, trails and other recreational facilities, giving due regard to any master plan adopted by the city and applicable federal and state regulations;
- 4. Study and recommend to the city council on matters relating to park and trail improvements, including potential methods of financing such improvements;
- 5. Assist the city council in ascertaining community attitudes, addressing community issues, and in invoking public awareness and involvement in teen activities;
- 6. Advise the city council on the development of initiatives and programs to fight obesity and chronic disease, support Healthy

- Communities concepts, and support existing coalitions to collectively advance community health and wellness;
7. Make recommendations to the city council regarding the development of teen programs, activities and facilities;
 8. Make recommendations to the city council regarding various equestrian issues, including an equestrian center, horse shows, horsemanship and other horse-related activities;
 9. Subject to city council approval in each instance, solicit and accept grants and donations to the city in aid of carrying out the general and specific duties of the committee;
 10. At least once each year report committee activities to the city council.
 11. Coordinate planned activities related to the purpose of the committee with other agencies not under jurisdiction of the city as approved by the city council;
 12. All reports of the committee shall be made to the city council through the office of the Parks and Community Services director;
 13. To carry out such other functions as may be assigned to the committee by the city council.

Section 2.19.040 Chair, committees and staff.

Designation of a chairperson and vice-chairperson for the committee shall be governed by Section 2.06.020. The committee may establish such standing and temporary subcommittees as it may deem expedient for the performance of its duties, and the chairperson, with the consent of the committee, may fix and appoint the membership of such subcommittees. Except that the chairperson of each such subcommittee shall be a member of the committee, membership on a subcommittee need not be limited to members of the committee. The city manager may appoint a secretary and other staff for the committee and provide such reimbursement for their necessary expenses as may be authorized by the city council in the city budget and approved in advance by the city manager.

Section 2.19.050 Meetings and rules of procedure.

The committee shall hold regular meetings at least four times per year and designate the times, dates and places therefor. All meetings of the committee and each of its subcommittees shall be open to the public. Special meetings may be called by the chairperson or by a majority of the committee, provided that notice of such special meetings is given to each member of the committee at least forty-eight (48) hours prior to the time of the meeting. Three or more voting members of the committee shall

constitute a quorum for the conduct of business. The committee shall adopt rules for the transaction of its business. The committee shall keep a public record of its actions. Promptly after approval thereof by the committee, the original minutes of committee meetings shall be filed with the Parks and Community Services Department.

SECTION 5. Chapter 2.24 of the Moreno Valley Municipal Code is hereby repealed in its entirety.

SECTION 6. Any other reference made in the Moreno Valley Municipal Code to either the Parks and Recreation Commission or the Recreational Trails Board not specifically addressed in this amendment is now intended to reflect, and hereby amended to reflect, the Parks, Community Services and Trails Committee and can be corrected as a clerical omission; all other terms or provisions of the Municipal Code inconsistent with this Ordinance are hereby repealed.

SECTION 7. SEVERABILITY.

If any provision, clause, sentence or paragraph of this Ordinance or the application thereof to any person or circumstances shall be held invalid, such invalidity shall not affect the other provisions or application of the provisions of this Ordinance which can be given effect without the invalid provision or application, and to this end, the provisions of this Ordinance are hereby declared to be severable.

SECTION 8. EFFECTIVE DATE.

This Ordinance shall take effect thirty (30) days after its adoption.

INTRODUCED at the December 19th, 2017 City Council meeting; APPROVED AND ADOPTED this _____ day of _____, _____.

Mayor

ATTEST:

City Clerk

APPROVED AS TO FORM:

City Attorney

Attachment: PCST Committee Ordinance Draft (2) [Revision 1] (2911 : CONSIDERATION OF ORDINANCE _____ CREATING THE PARKS,

ORDINANCE JURAT

STATE OF CALIFORNIA)
COUNTY OF RIVERSIDE) ss.
CITY OF MORENO VALLEY)

I, Pat Jacquez-Nares, City Clerk of the City of Moreno Valley, California, do hereby certify that Ordinance No. YYYY-____ was duly and regularly adopted by the City Council of the City of Moreno Valley at a regular meeting thereof held on the ____ day of _____, YYYY, by the following vote:

AYES:

NOES:

ABSENT:

ABSTAIN:

(Council Members, Mayor Pro Tem and Mayor)

CITY CLERK

(SEAL)